

momenti[®]
ITALIAN CUSTOM DESIGN

Art Gallery
Painting

momenti®
ITALIAN CUSTOM DESIGN

Sentitevi liberi di scegliere, di cambiare.
Questa è libertà di espressione.

/ Feel free to choose, to change.
This is freedom of expression.

L'esigenza di creare e di mettersi in gioco sono le carte vincenti di Momenti®, un nuovo modo di pensare, di vedere e di concepire l'ambiente per renderlo unico e personale. Nel 2005, Alexander e Matteo Bagnai iniziano un percorso fra imprenditorialità e inventiva, e il risultato, ancora oggi, è un'alchimia suggestiva che caratterizza oggetti unici. Momenti® riveste qualsiasi superficie, che sia un pavimento, una parete o un oggetto d'arredo, attraverso soluzioni emozionanti e di grande fascino. Il processo lavorativo permette di personalizzare ogni tipo di rivestimento partendo da un'idea, un'intuizione, un semplice disegno fornito dal cliente o da un'immagine presente sui nostri cataloghi. La nostra non è una classica gamma di rivestimenti, non è un campionario passivo di colori alla moda. Preferiamo pensare alle nostre creazioni come a strumenti di libera interpretazione, da utilizzare sia nelle dosi consigliate, che esagerandone la perfezione. Purché vi renda felici, ogni cosa è design: colore, materia, citazione, licenza poetica, rigore, visione. Il Momenti® Lab, nostro ufficio tecnico e creativo, interagisce direttamente con designer, architetti e professionisti del settore, per trovare soluzioni idonee a ogni tipo di ambiente. Forte di numerose collaborazioni fra designers, artisti, grafici, illustratori e artigiani, Momenti® lavora con lo sguardo rivolto al

futuro in costante movimento. Le nostre collezioni nascono da continue prove di materiali, ricerche di finitura, di resistenza, di rispetto per l'ambiente e di continuo entusiasmo. L'obiettivo è divulgare la qualità del Made in Italy, un'eccellenza desiderata in tutto il mondo da chi ricerca prodotti altamente personalizzabili e perfettamente coordinabili. L'italianità dei nostri prodotti è sinonimo di grande attenzione nei confronti di ogni processo produttivo, dalla scelta dei materiali e loro qualità, alla cura dei dettagli. **Tutto viene eseguito rigorosamente a mano.** Ogni prodotto, infatti, attraversa tutte le fasi di realizzazione - dall'ideazione alla produzione sul nostro territorio - a tenace salvaguardia di un comparto manifatturiero caratterizzato da creatività e abilità. Mantenere questi standard di qualità, significa per noi offrire ai nostri clienti collezioni uniche, scelte esclusive e soluzioni innovative e versatili. **È per questo che amiamo definirci i "Sarti del Design Italiano".** Nascono così stampe artistiche, elementi d'arredo, rivestimenti dalla forte impronta artistica e vestiti di immagini emozionanti. Il risultato finale è arte applicata al design quotidiano.

/ Involvement and creativity are Momenti's winning cards®, a new way of thinking, seeing and conceiving the environment, to make it unique and personal. In 2005, Alexander and Matteo Bagnai began a journey embracing entrepreneurship and inventiveness, dedicated to the house and its elements. The passion for creativity was immediately expressed and the result, even today, is a suggestive alchemy that characterizes unique objects. Momenti® covers any surface, whether a floor, a wall or a piece of furniture, through exciting and fascinating solutions. The process allows you to customize each type of coating starting from an idea, an intuition, a simple design provided by the customer or an image present in our catalogs. Not a classic range of coverings, not a passive sample of fashionable colors; we prefer to call our creations tools of free interpretation, both usable in the recommended doses, exaggerating their perfection. As long as it is pleasing, all is design; color, fabric, quote, poetic license, rigor, vision. Momenti® Lab, our technical and creative office, interacts directly with designers, architects and professionals in the sector, to find suitable solutions for every type of environment. Availing of excellent collaborations between designers, artists, graphic designers, illustrators and artisans, Momenti® operates with an eye towards the

ever-changing future. Our collections are born from continuous tests of materials, research of finishing, resistance, continuous enthusiasm and environment friendly. The end goal is to spread the Made in Italy quality, a desired excellence all over the world by those who seek highly customizable and perfectly coordinated products. The Italian nature of our products is always synonymous with great care of every production process, from choice of materials, their quality to attention to detail. **Everything is strictly hand-crafted;** in fact, each product goes through all the stages of production - from conception to production on our territory - to a tenacious safeguard of a manufacturing sector characterized by creativity and skill. For us, maintaining these quality standards means to offer our customers unique collections, exclusive choices, innovative and versatile solutions. **This is why we love to call ourselves the "Tailors of Italian Design".** This is how artistic prints, furnishing elements, coverings with a strong artistic imprint and dresses of moving images are born. The end result is art applied to everyday design.

Indice

/ Index

8	Painting	132	Ashima Kumar
16	Marco Anconelli	136	Samuele "Man-Zú" Manzoni
22	Archivio Spadacini	140	Luis Martin
26	Laurent Baheux	146	Riccardo Morvillo
32	Mateo Bories	150	Peeter Must
36	Matteo Bosi	156	Riccardo Raul Papavero
40	Tommaso "iomso" Cavallini	162	Michele Pau
44	Alessandro Corina	166	Ludmilla Radchenko
48	Rosso Emerald Crimson (Rosso Artist)	172	Carlo Ravaioli
52	Enrico De Luigi	176	Reve+ (Beltrami Matteo)
60	Shirin Donia	182	Mr. Sados
66	Ivana Dostalova	186	SNYDER
72	Claudio Fabbri Ferrini	190	Jessica Incerti Telani
76	Rie Froehlich	194	Daniela Tzvetkova
82	Michela Gioachin	198	Momenti Lab
86	Marco Grassi	226	Sezione Tecnica
98	Honet		/ Technical section
102	Darren Hopes	246	Designers
106	Michelino Iorizzo		
112	Giulio Iurissevich		

Painting

Stampa artistica su sei differenti supporti:

- Ecopannello alveolare con rivestimento materico
- Pmma
- Alluminio con rivestimento materico
- Telato in alluminio con rivestimento in tessuto "Tecno Fiber"
- Fonoassorbente con polietilene e poliestere acustico
- Fonoassorbente in lana di vetro

/ Artistic print on six different materials:

- Alveolar ecopanel with material covering
- Pmma
- Aluminium with material coating
- Aluminium canvas with "Tecno Fiber" fabric covering
- Sound absorbing with acoustic polyethylene and polyester
- Glass wool sound absorbing

Painting

Momenti offre la possibilità di decorare i propri ambienti con una vasta gamma di stampe artistiche. Con la Collezione Painting, offriamo sei materiali di grande pregio, sui quali ogni design d'autore prende vita:

- Ecopannello alveolare;
- Pmma;
- Alluminio con rivestimento materico;
- Telato in alluminio con Tecno Fiber;
- Fonoassorbente con polietilene e poliestere acustico;
- Fonoassorbente in lana di vetro.

/ Momenti offers the chance to decorate your spaces with a wide range of furnishing accessories and artistic prints. With the Painting Collection, we offer six materials of great value, on which each design from our artists comes to life:

- Alveolar ecopanel;
- Pmma;
- Aluminium with material covering;
- Aluminium canvas with Tecno Fiber;
- Sound absorbing in acoustic polyethylene and polyester;
- Glass wool sound absorbing.

Vedi scheda tecnica *Painting* p. 230
/ See *Painting* technical sheet p. 230

Supporti e misure disponibili indicate in cm (LxA)
/ Available materials and sizes in cm (WxH)



Misure standard configurabili a listino / Standard sizes configurable in the price list

Ecopannello alveolare / Alveolar ecopanel
50x50 | 100x100
90x70 | 100x50 | 160x60 | 150x100
70x90 | 50x100 | 100x150

PMMA / PMMA
50x50 | 100x100 | 120x120 | 150x150
90x70 | 100x50 | 160x60 | 150x100 | 200x100
70x90 | 50x100 | 100x150 | 100x200

Alluminio con rivestimento materico / Aluminium with material covering
50x50 | 100x100 | 120x120 | 150x150
90x70 | 100x50 | 160x60 | 150x100 | 180x120 | 200x100
70x90 | 50x100 | 100x150 | 120x180 | 100x200

Telato in alluminio con Tecno Fiber / Aluminium canvas with Tecno Fiber
50x50 | 88x88 | 120x120 | 150x150
88x70 | 88x50 | 160x60 | 150x88 | 180x120 | 200x88
70x88 | 50x88 | 88x150 | 120x180 | 88x200

Fonoassorbente con polietilene e poliestere acustico / Sound absorbing in acoustic polyethylene and polyester
50x50 | 100x100 | 120x120 | 150x150
90x70 | 100x50 | 160x60 | 150x100 | 180x120 | 200x100
70x90 | 50x100 | 100x150 | 120x180 | 100x200

Fonoassorbente in lana di vetro / Glass wool sound absorbing
52,5x52,5 | 102,5x102,5 | 122,5x122,5
102,5x52,5 | 152,5x102,5 | 182,5x122,5 | 202,5x102,5
52,5x102,5 | 102,5x152,5 | 120,5x182,5 | 102,5x202,5

Personalizzazioni / Customization

Ecopannello Alveolare / Alveolar ecopanel
Dimensione minima / minimum size 50x50
Dimensione massima / maximum size 100x150

PMMA / PMMA
Dimensione minima / minimum size 50x50
Dimensione massima / maximum size 150x250

Alluminio con rivestimento materico / Aluminium with material covering
Dimensione minima / minimum size 50x50
Dimensione massima / maximum size 200x400

Telato in alluminio con Tecno Fiber / Aluminium canvas with Tecno Fiber
Dimensione minima / minimum size 50x50
Dimensione massima / maximum size 180x385

Fonoassorbente con polietilene e poliestere acustico / Sound absorbing in acoustic polyethylene and polyester
Dimensione minima / minimum size 50x50
Dimensione massima / maximum size 295x295

Fonoassorbente in lana di vetro / Glass wool sound absorbing
Dimensione minima (comprensiva di cornice) / minimum size (including frame) 52,5x52,5
Dimensione massima (comprensiva di cornice) / maximum size (including frame) 122,5x292,5

Cornici / Frames

Cornici per pannelli in Pmma e alluminio con rivestimento materico / Frames for Pmma and aluminium panels with material covering

Modello LEWIS
/ LEWIS model

Cornice con profilo lineare in legno massello.
Finitura laccata a poro chiuso nel colore nero o bianco.
Predisposta per aggancio a parete.

/ Frame with linear profile in solid wood
Closed-pore lacquered finish in black or white.
Wall hardware included.

Dimensione minima (comprensiva di cornice) / minimum size (including frame) 53,5x53,5
Dimensione massima (comprensiva di cornice) / maximum size (including frame) 203x295



Cornici per pannelli in Pmma e alluminio con rivestimento materico / Frames for Pmma and aluminium panels with material covering

Modello CLARK
/ CLARK model

Cornice con profilo sagomato in legno massello.
Finitura laccata a poro chiuso nel colore nero o bianco.
Predisposta per aggancio a parete.

/ Frame with shaped profile in solid wood
Closed-pore lacquered finish in black or white.
Wall hardware included.

Dimensione minima / minimum size 59x59
Dimensione massima / maximum size 209x295

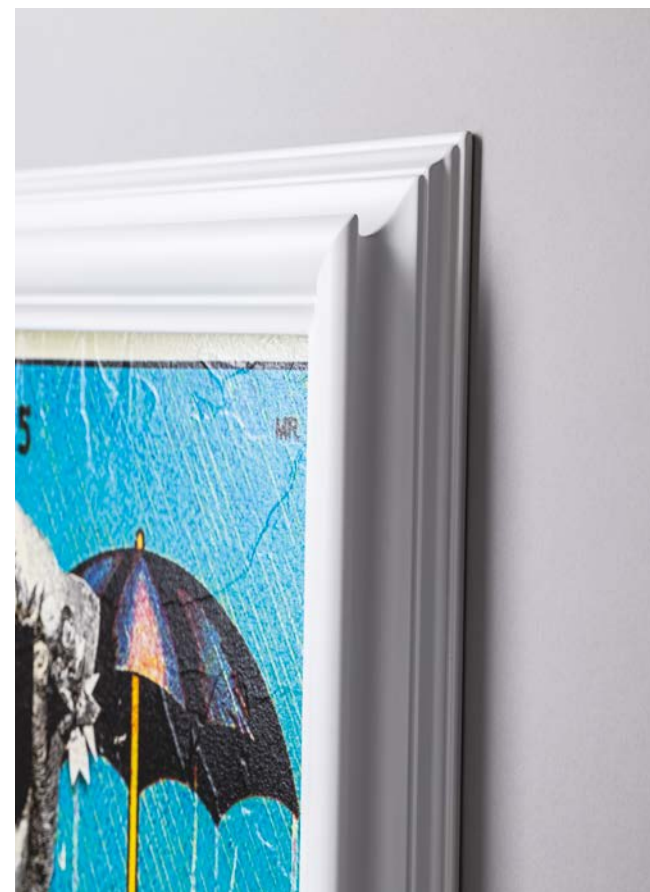

Cornici / Frames

Cornici per pannelli fonoassorbenti in lana di vetro ad alta densità / Frames for sound-absorbing panel in high density glass wool

Cornice con profilo lineare in legno massello. Finitura laccata a poro chiuso nel colore nero o bianco. Predisposta per aggancio a parete.

La scelta della cornice non è opzionale, il pannello è già comprensivo di cornice. Il cliente può decidere il colore della laccatura.

/ Frame with linear profile in solid wood. Closed-pore lacquered finish in black or white. Wall hardware included.

The choice of the frame is not optional, the panel already includes the frame. The customer can decide the color of the lacquer.

Dimensione minima / minimum size 52,5x52,5
Dimensione massima / maximum size 122,5x292,5



Marco Anconelli

Nato nel 1984, da autodidatta si affaccia al mondo della fotografia. Mosso da una passione incontenibile, non si separa mai dalle sue fotocamere, con cui realizza reportage di viaggio in tutta Europa con occhio sempre attento a composizioni e atmosfere ricercate.

/ Born in 1984, as a self-taught artist, he enters the world of photography. Moved by an uncontrollable passion, he never parts from his cameras, with which he makes travel reports all around Europe with an eye always attentive to compositions and refined atmospheres.

Artist : Marco Anconelli



AN-002

Artist : Marco Anconelli



AN-005

Artist : Marco Anconelli



AN-006

Artist : Marco Anconelli



AN-008

Artist: Marco Anconelli

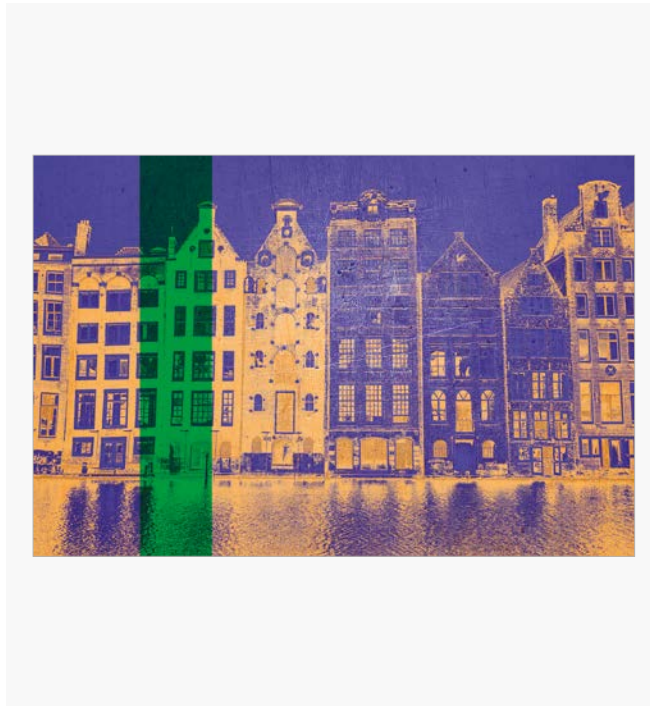

AN-009

Artist: Marco Anconelli

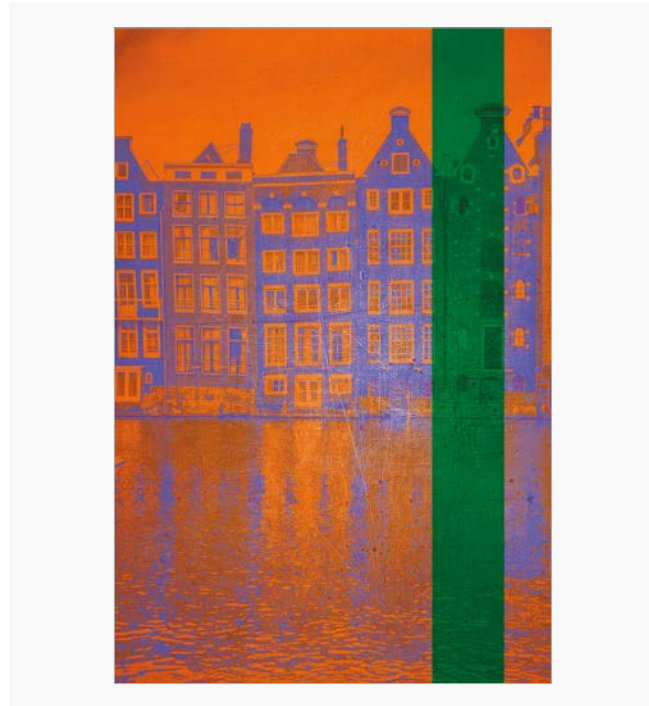

AN-010

Artist: Marco Anconelli

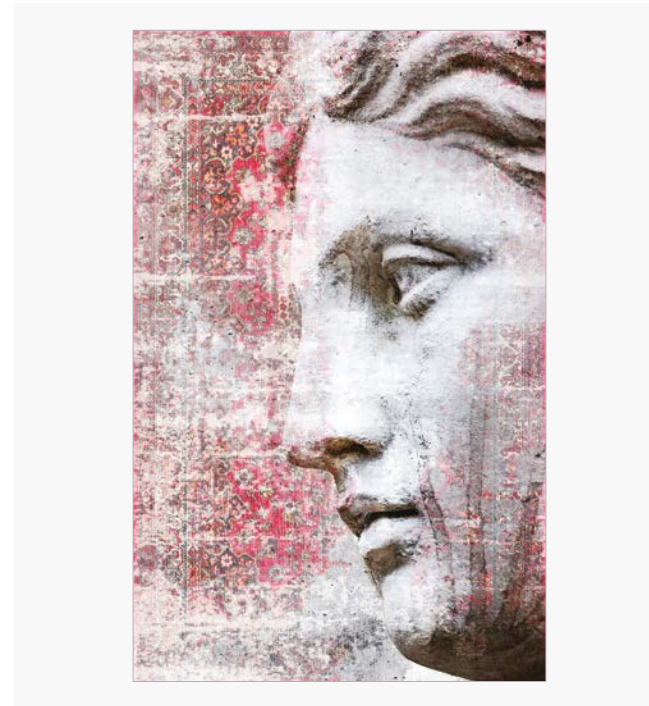

AN-015

Artist: Marco Anconelli

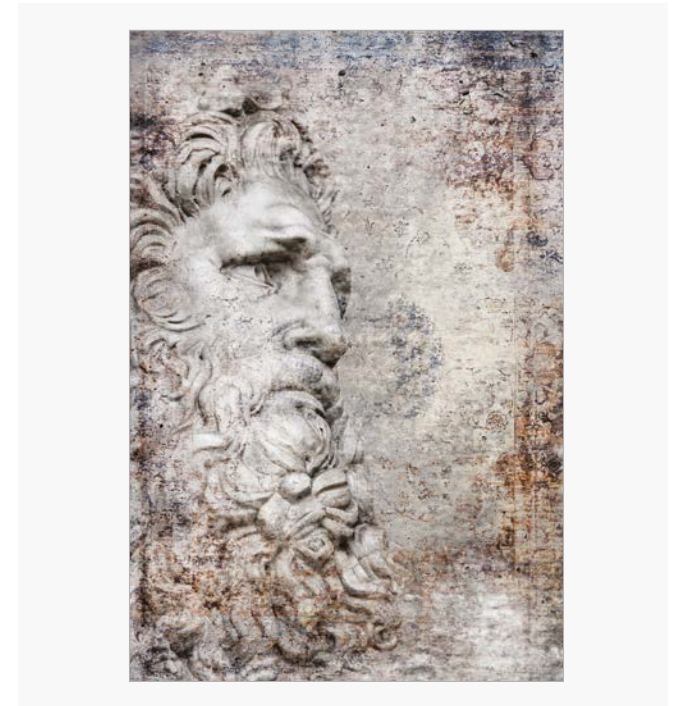

AN-016

Artist: Marco Anconelli



AN-012

Artist: Marco Anconelli



AN-013

Artist: Marco Anconelli

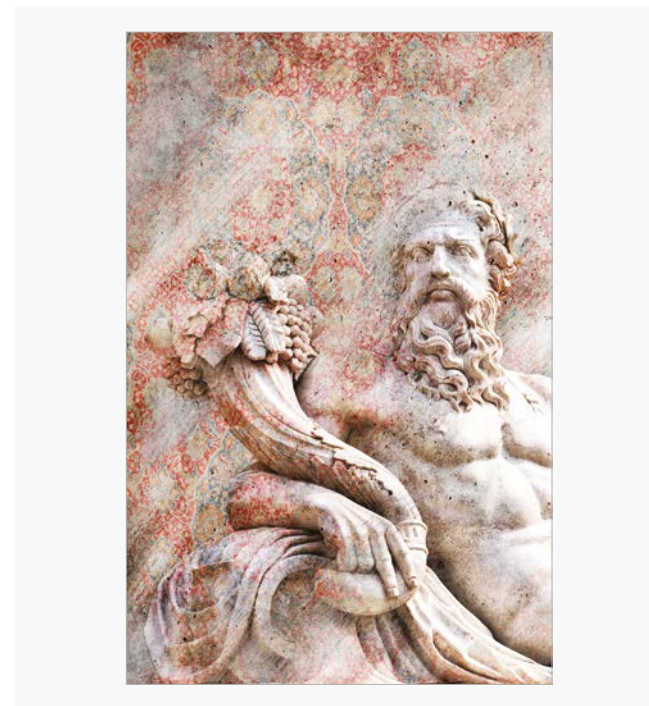

AN-017

Artist: Marco Anconelli

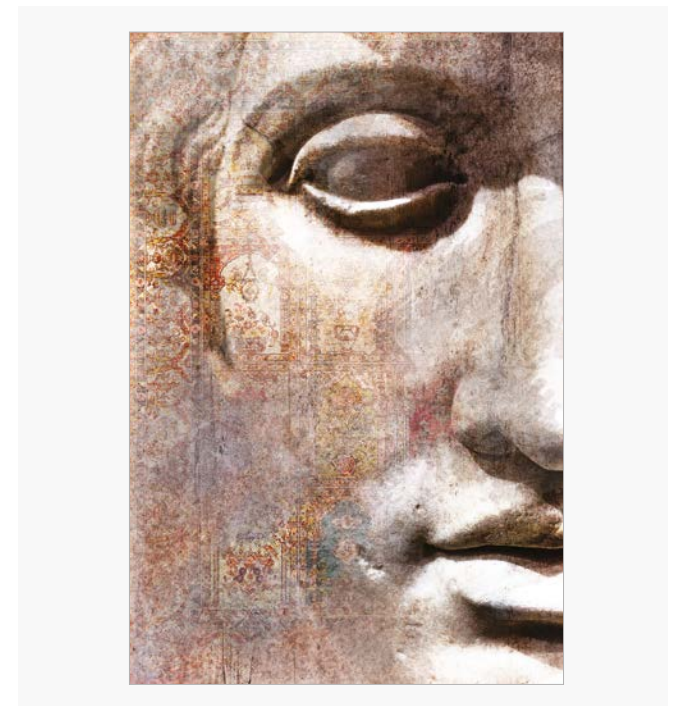

AN-018

Artist: Marco Anconelli

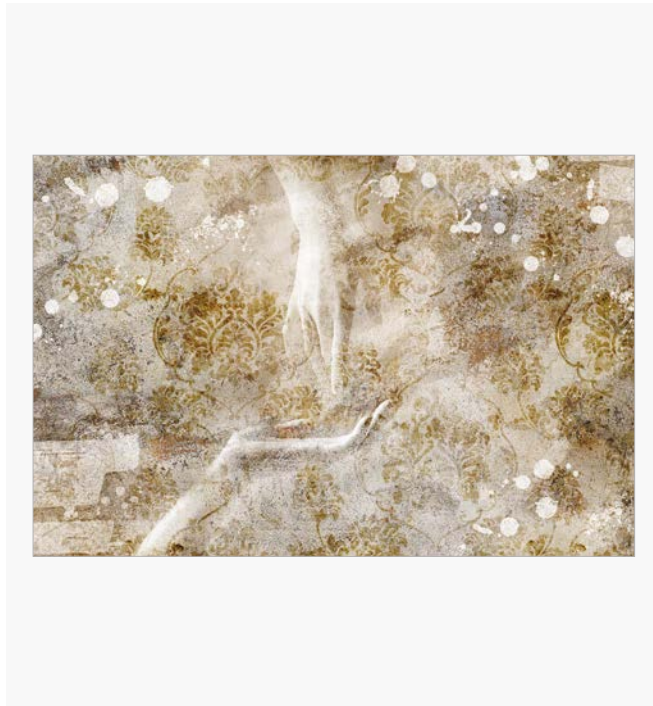

AN-019

Artist: Marco Anconelli

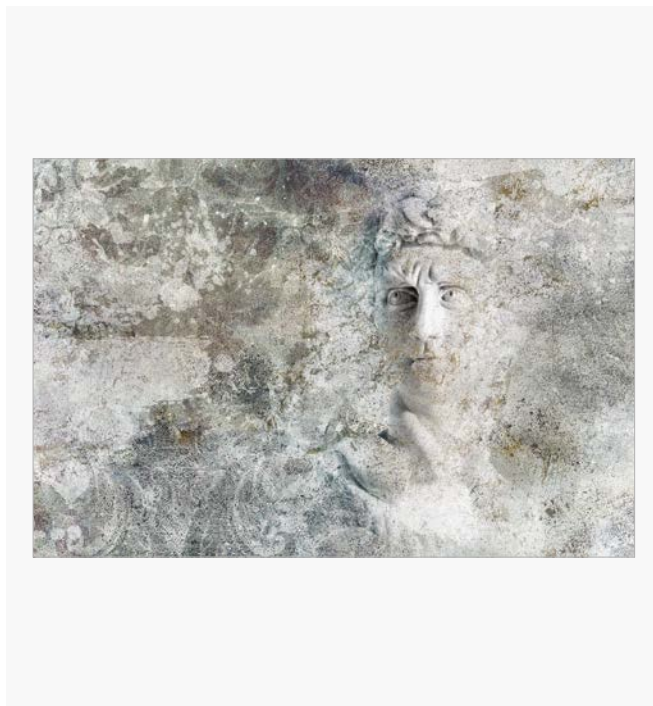

AN-021

Artist: Marco Anconelli



AN-020

Artist: Marco Anconelli

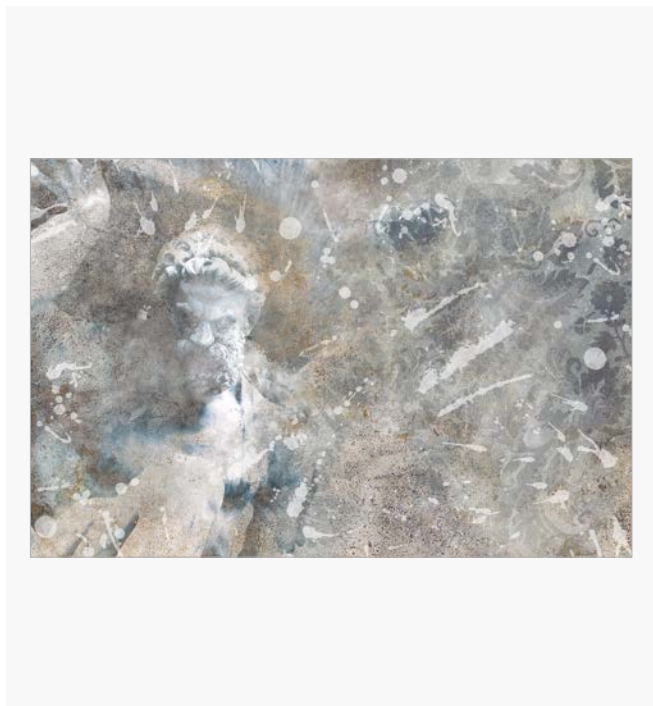

AN-022



Archivio Spadacini

Consulenti creativi ma non solo: progettazione di decori e disegni, assistenza tecnica, ricerche personalizzate all'interno del patrimonio culturale dell'Archivio Spadacini. *Creatività*: disegni originali realizzati sia manualmente che con software di grafica, singoli oppure in serie, coordinati per temi e colori. I disegni sono elaborati per soddisfare ogni esigenza tecnica di rendering o di stampa in serie e di variantatura cromatica. *Consulenza* sui "trend colore" stagionali organizzati in mood-board oppure tramite elaborazione di consulenze specifiche. Realizzazione di un progetto "chiavi in mano" che rispecchi appieno l'identità e le richieste del committente, beneficiando del patrimonio culturale dell'Archivio Spadacini. Accesso alla biblioteca digitale dell'Archivio ed alle fonti ad esso collegate per realizzare una ricerca approfondita e personalizzata.

/ Creative consultants but not only: design of decorations, drawings, technical assistance, personalized research within the cultural heritage of the Archivio Spadacini. *Creativity*: original drawings made both manually and with graphics software, single or in series, coordinated by themes and colors. The drawings are elaborated to meet every technical need of rendering or mass printing and color-ways. *Consulting* on seasonal "color trends" organized in mood-board or through the elaboration of specific advice. Realization of a "turnkey" project that fully reflects the identity and requests of the client, benefiting from the cultural heritage of the Spadacini Archive. Access to the digital library of the Archive and to the sources connected to it to carry out an in-depth and personalized research.

Artist: Archivio Spadacini



AS-001

Artist: Archivio Spadacini



AS-002

Artist: Archivio Spadacini



AS-003

Artist: Archivio Spadacini



AS-004

Artist: Archivio Spadacini



AS-005

Artist: Archivio Spadacini

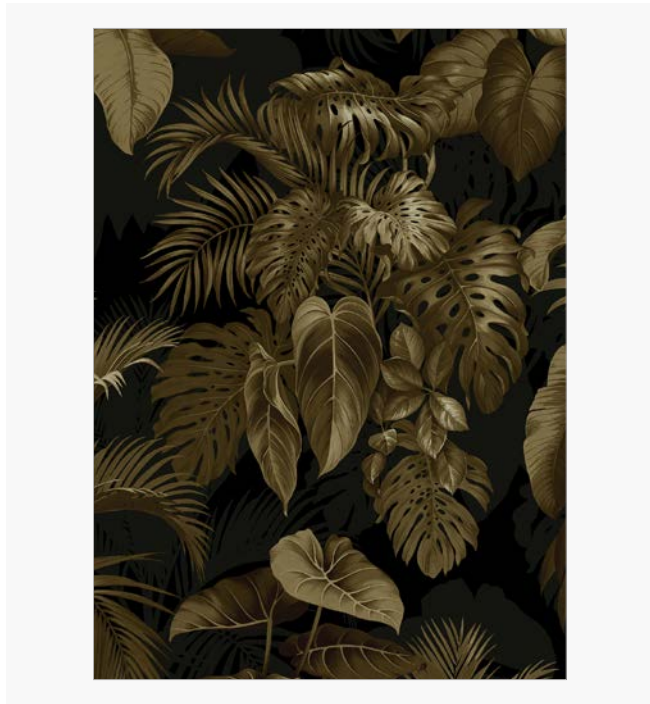

AS-006

Artist: Archivio Spadacini

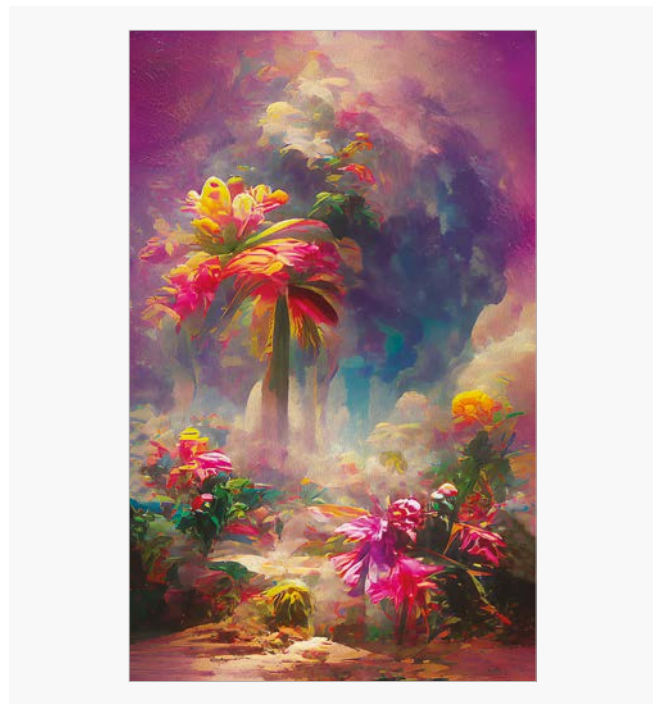

AS-007

Artist: Archivio Spadacini

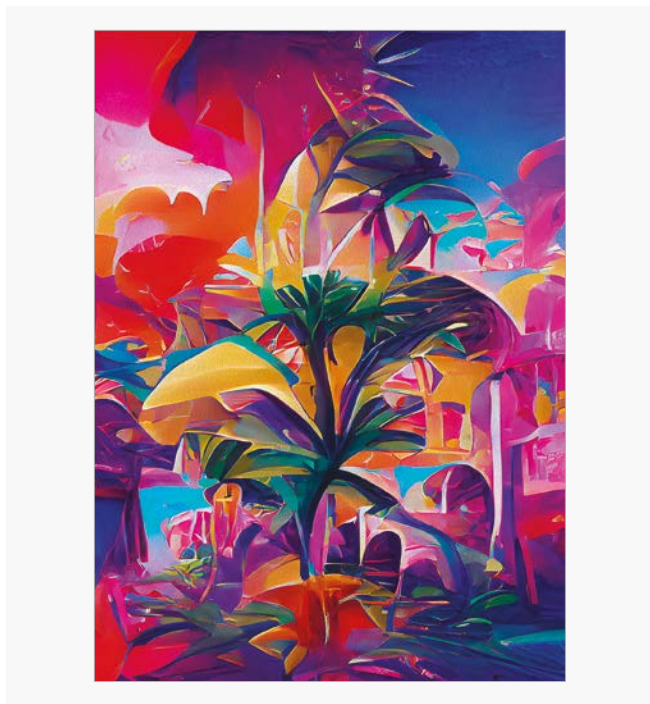

AS-008



Laurent Baheux

Nato nel 1970, a Poitiers, esordisce come autodidatta nei primi anni '90, all'epoca del cinema, come fotografo nella stampa sportiva regionale. Per trovare un posto nella professione, si è trasferito a Parigi, dove ha lavorato per importanti agenzie fotografiche e media specializzati in notizie sportive internazionali. Nel 2002 si è dedicato all'Africa e alla fauna selvatica dei grandi mammiferi terrestri. Nel 2007, dopo 5 anni di riprese nella savana, ha iniziato a mostrare le sue istantanee di animali selvatici catturati sul posto, istintivamente. Nel 2009 ha pubblicato il suo primo lavoro basato sul suo lavoro africano: «Terre des Lions» poi nel 2011 «D'ivoire & d'ébène». Nel 2013, è diventato ambasciatore di buona volontà per il Programma delle Nazioni Unite per l'ambiente e ha partecipato alla campagna anti-bracconaggio Wild & Precious. Lodate per la loro forza estetica e autenticità, le foto di Laurent sono oggetto di libri, pubblicazioni, mostre, conferenze e sono esposte in gallerie in Francia e all'estero.

/ Born in 1970, in Poitiers, he made his debut as an autodidact in the early 1990s, during the time of film, as a photographer in the regional sports press. To find a place in the profession, he moved to Paris, where he worked for major photo agencies and media specializing in international sports news. In 2002 he turned to Africa and the wildlife of large land mammals. In 2007, after 5 years of shooting in the savannah, he began to show his snapshots of wildlife captured on the spot, instinctively. In 2009, he published his first work based on his African work: «Terre des Lions» then in 2011 «D'ivoire & d'ébène». In 2013, he became a goodwill ambassador for the United Nations Environment Program and participated in the Wild & Precious anti-poaching campaign. Praised for their aesthetic strength and authenticity, Laurent's photos are the subject of books, publications, exhibitions, conferences and are shown in galleries in France and abroad.

Artist: Laurent Baheux



LB-001

Artist: Laurent Baheux



LB-002

Artist: Laurent Baheux



LB-003

Artist: Laurent Baheux



LB-004

Artist: Laurent Baheux



LB-005

Artist: Laurent Baheux



LB-006

Artist: Laurent Baheux



LB-009

Artist: Laurent Baheux

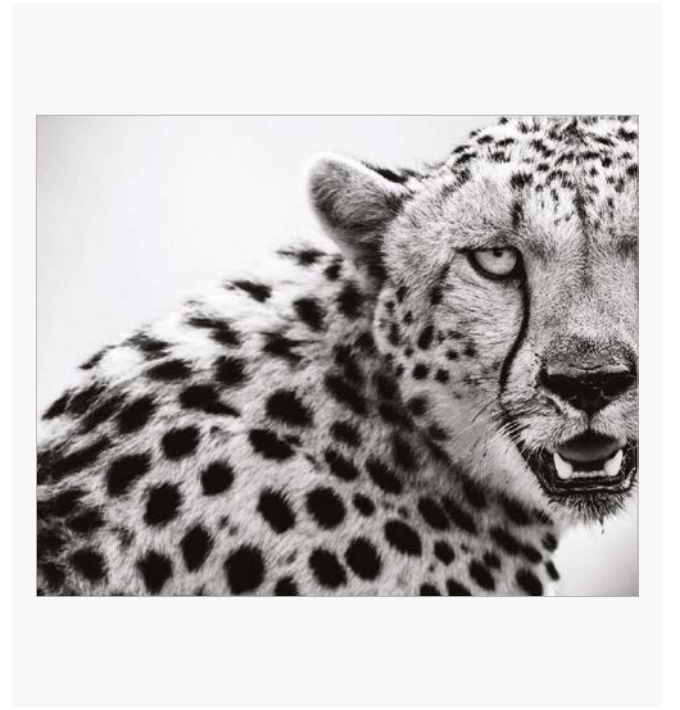

LB-010

Artist: Laurent Baheux



LB-007

Artist: Laurent Baheux

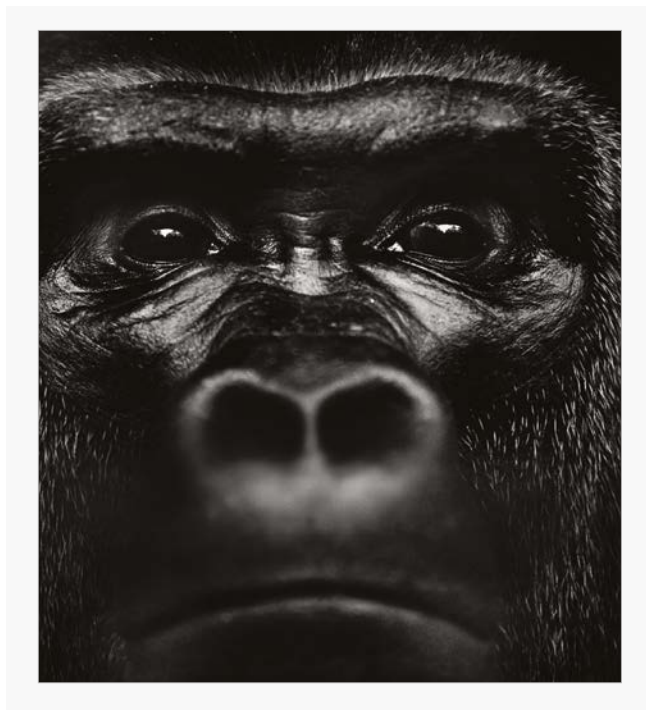

LB-008

Artist: Laurent Baheux



LB-011

Artist: Laurent Baheux



LB-012

Artist: Laurent Baheux



LB-013

Artist: Laurent Baheux



LB-014

Artist: Laurent Baheux



LB-015

Artist: Laurent Baheux



LB-016

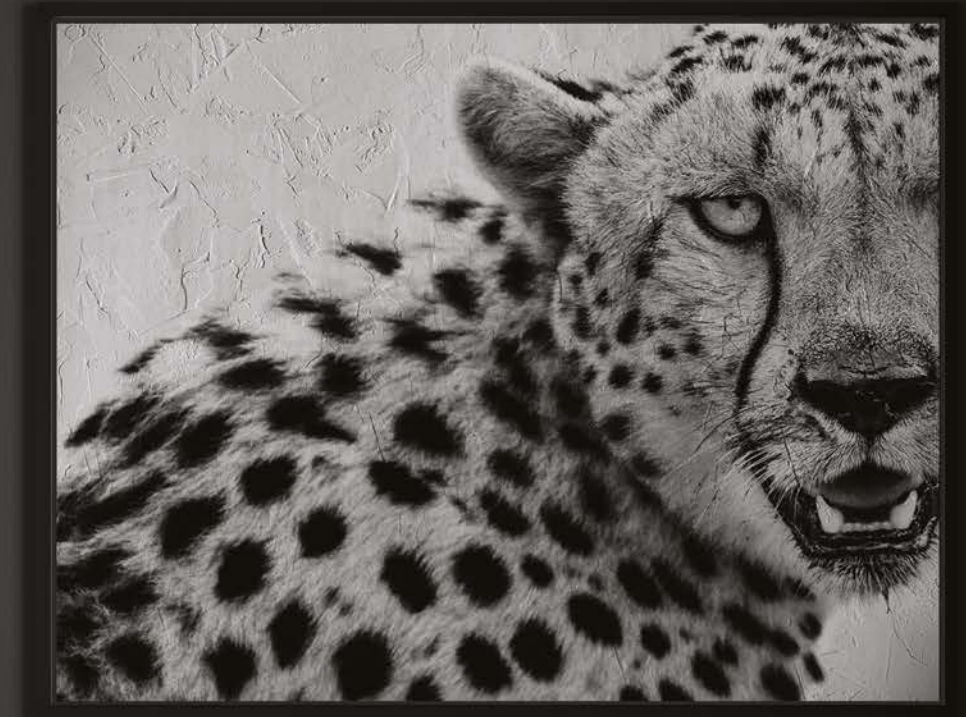

Mateo Bories

Nato in Francia nel 1985, Mateo si interroga sulla percezione del mondo che ci circonda e sull'impatto della tradizione sulle nostre società occidentali. Dopo aver conseguito un master in Arte a Tolosa, si reca a Montreal nel 2008 per lavorare come grafico. Quindi inizia un lungo viaggio in giro per il Sud America dove ancora produce e dipinge murali con il filo dei suoi incontri. Tornato a Montreal decide di dedicarsi interamente all'arte. La sua pratica si è sempre evoluta tra strada e studio, largamente influenzata dal movimento della Street Art con una totale libertà di materiali. Il suo approccio umanistico si propone di riconnettersi con ispirazioni fondamentali, un ponte verso le nostre origini profonde e un romanticismo cancellato nella nostra società contemporanea. Possiamo vedere il suo lavoro in Francia, Argentina, Canada, Stati Uniti, Spagna, Messico, Colombia...

/ Born in France in 1985, Mateo questions the perception of the world around us and the impact of tradition on our Western societies. After earning a Masters in Art in Toulouse, he went to Montreal in 2008 to work as a graphic designer. Then he begins a long journey around South America where he still produces and paints murals with the thread of his encounters. Back in Montreal he decides to devote himself entirely to art. His practice has always evolved between street and study, largely influenced by the Street Art movement with total freedom of materials. His humanistic approach aims to reconnect with fundamental inspirations, a bridge to our deep origins and an erased romanticism in our contemporary society. We can see his work in France, Argentina, Canada, United States, Spain, Mexico, Colombia ...

Artist: Mateo Bories

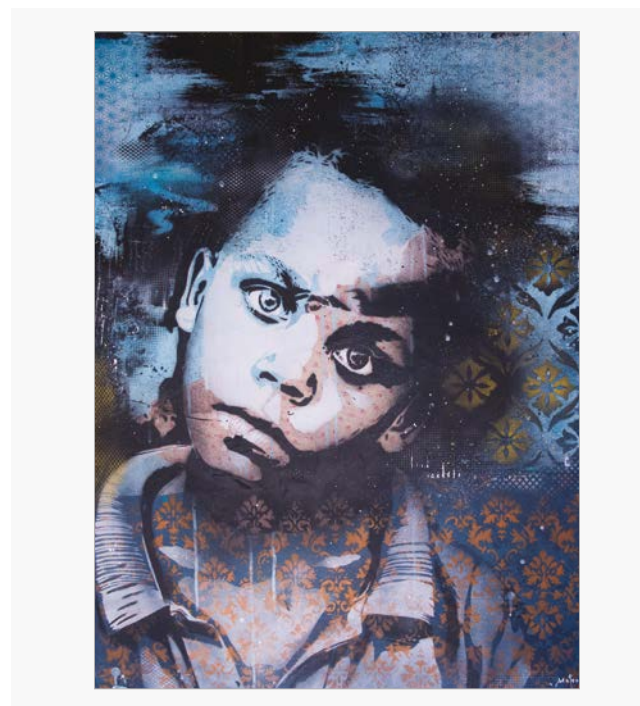

MB-001

Artist: Mateo Bories



MB-002

Artist: Mateo Bories

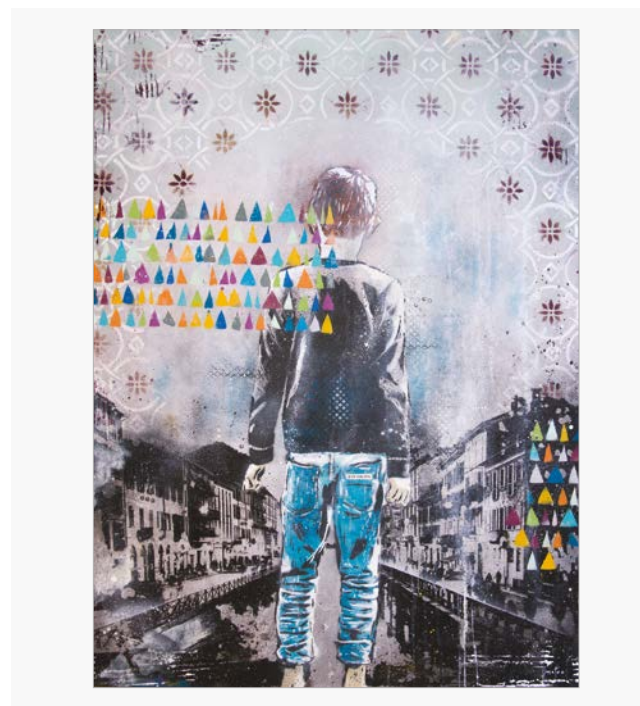

MB-003

Artist: Mateo Bories

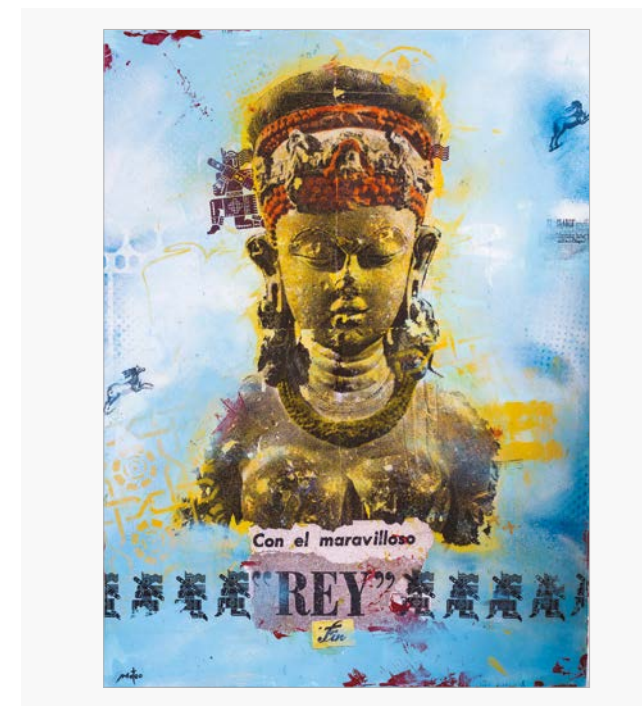

MB-004

Artist: Mateo Bories

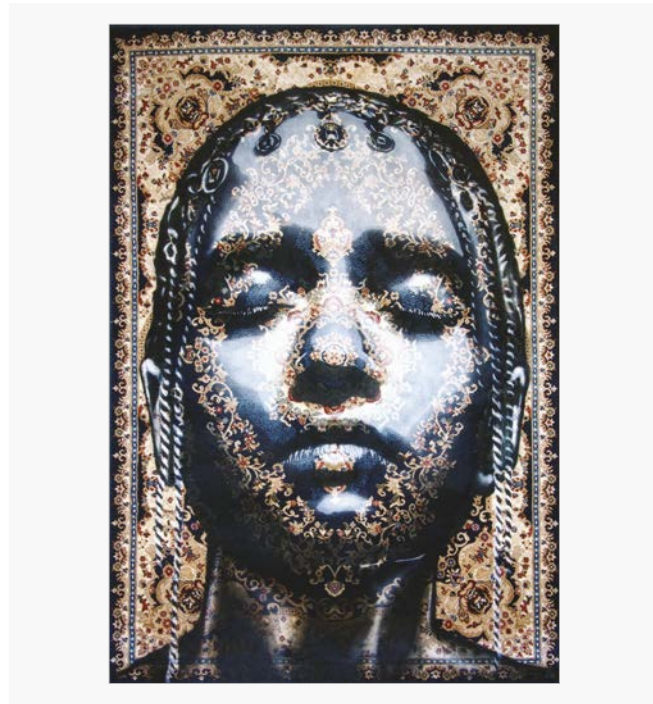

MB-005

Artist: Mateo Bories



MB-007

Artist: Mateo Bories



MB-008

Artist: Mateo Bories



MB-010



Matteo Bosi

Matteo Bosi è nato nel 1966 a Cesena. Ama sperimentare, utilizzando molteplici strumenti espressivi, e per questa ragione il suo lungo percorso artistico è caratterizzato da una continua ricerca. È alla fine degli anni '80 che comincia a lavorare con la fotografia analogica, arrivando in pochi anni ad utilizzare anche le tecniche digitali. Sono della metà degli anni '90 le prime serie di fotografie manipolate in post produzione o dipinte a mano raccolte nella serie *Ultra Homines*. Ha esposto la sua arte in numerose collettive e personali in gallerie di tutta Europa. Sono degne di nota alcune menzioni speciali quali il *premio celeste* e le due edizioni del *Tau Visual Italia*. Nel 2013 si è recato a Mosca per una mostra personale e l'anno successivo a Barcellona, per poi approdare nel 2016 all'importante evento internazionale *Nord Art* in Germania. Le sue fotografie, già inserite nel progetto *DOC Centro di Documentazione Arti moderne e contemporanee in Romagna* (Imola), sono anche presenti nell'importante cornice del progetto espositivo *Esercizi dello sguardo*, Centro Culturale Mercato di Argenta (Fe) 2018. Dal 2000 lavora anche da libero professionista come *communication designer*. Ha collaborato per alcuni anni alla realizzazione delle serigrafie d'arte di Dario Fo e curato le grafiche dell'edizione del *San Marino International Film Festival* del 2010 e quella del *Montefeltro Film School Festival* del 2015. Nel 2016 ha realizzato la mostra fotografica *Ciao Marcello* dedicata a Marcello Mastroianni e nel '19 quella su *Fellini ritrovato. 8 ½ nelle fotografie inedite di Paul Ronald*, anche questa mostra fotografica racconta il backstage del cinema italiano portando alla luce l'archivio fotografico del *Centro Cinema di Cesena*. Nel 2021 ha realizzato un docufilm dedicato al Teatro Alessandro Bonci di Cesena. Nel 2022 partecipa alla esposizione *Other Identity Altre forme di identità culturali e pubbliche*, Genova Guidi&Schoen-Arte Contemporanea e inizia una collaborazione con la Galleria Secret Art Ltd di Londra.

/ Matteo Bosi was born in 1966 in Cesena. He loves experimenting, using multiple expressive tools, and for this reason his long artistic career is characterized by continuous research. It was at the end of the 1980s that he began to work with analog photography, arriving in a few years also using digital techniques. The first series of photographs manipulated in post production or hand painted in the *Ultra Homines* series are from the mid-1990s. He has exhibited his art in numerous group and solo exhibitions in galleries throughout Europe. Some special mentions are worthy of note such as the *celeste* award and the two editions of *Tau Visual Italia*. In 2013 he went to Moscow for a solo exhibition and the following year to Barcelona, before arriving in 2016 at the important international *Nord Art* event in Germany. His photographs, already included in the *DOC Center for Documentation of Modern and Contemporary Arts* in Romagna (Imola) project, are also present in the important setting of the *Esercizi dello sguardo*, Centro Culturale Mercato di Argenta (Fe) 2018. Since 2000 he has also worked as a freelancer as a *communication designer*. He collaborated for some years in the realization of the art serigraphs of Dario Fo and edited the graphics of the 2010 edition of the *San Marino International Film Festival* and that of the 2015 *Montefeltro Film School Festival*. In 2016 he created the photographic exhibition *Ciao Marcello* dedicated to Marcello Mastroianni and in 1919 the one on *Fellini ritrovato. 8 ½ in the unpublished photographs by Paul Ronald*, this photographic exhibition also tells the backstage of Italian cinema, bringing to light the photographic archive of the *Centro Cinema* in Cesena. In 2021 he made a docufilm dedicated to the Alessandro Bonci Theater in Cesena. In 2022 he participated in the exhibition *Other Identity Other forms of cultural and public identity*, Genova Guidi & Schoen-Arte Contemporanea and began a collaboration with the Secret Art Ltd Gallery in London.

Artist: Matteo Bosi



MT-001

Artist: Matteo Bosi



MT-002

Artist: Matteo Bosi



MT-003

Artist: Matteo Bosi

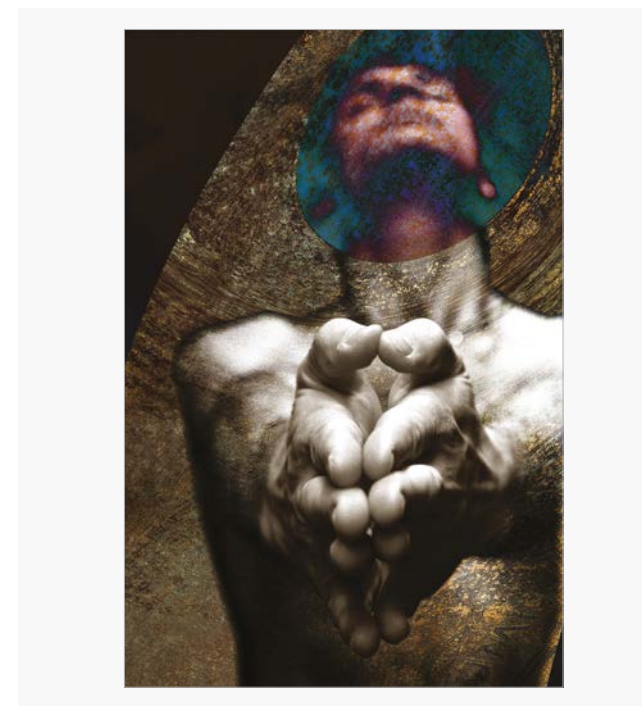

MT-004

Artist: Matteo Bosi



MT-005

Artist: Matteo Bosi



MT-006

Artist: Matteo Bosi



MT-007

Artist: Matteo Bosi



MT-008



Tommaso "iomso" Cavallini

Le opere di IOMSO vogliono indicare una realtà artigianale e artistica italiana tra ritrattistica, pop e street art, collegata anche con il mondo del tattoo, usando icone, grafismi, personaggi popolari insieme a disegni inediti. Nei suoi lavori usa tecnica a tempera ad olio, collages, plexiglas, legno, metalli, con una continua ricerca dei dettagli. Attraverso i suoi lavori il viso e il corpo dei personaggi riescono a esercitare potere di fascinazione, diventano essi stessi oggetti di design. Si tratta, quindi, di immagini che vengono sottratte alla morte e restano vive eternamente. Responsabile dello studio ed elaborazione di progetti tra grafica visiva aziendale ed editoria, allestimenti in collaborazione con lo studio architettonico per eventi e fiere, progettazione grafica web. Dal 2003 ha un laboratorio di pittura a Milano e a Cusago dove sviluppa i pezzi artistici, serigrafia, incide.

/ The works of IOMSO want to indicate an Italian artisan and artistic reality between portraiture, pop and street art, also connected with the world of tattoos, using icons, graphics, popular characters together with unpublished drawings. In his works he uses oil tempera technique, collages, Plexiglas, wood, metals, with a continuous search for details. Through his works the face and body of the characters manage to exert the power of fascination, they themselves become objects of design. It is therefore a question of images that are subtracted from death and remain eternally alive. Responsible for the study and development of projects between corporate visual graphics and publishing, set-ups in collaboration with the architectural studio for events and fairs, web graphic design. Since 2003 he has a painting workshop in Milan and Cusago where he develops artistic pieces, serigraphs, engraves.

Artist: Tommaso "iomso" Cavallini



TC-001

Artist: Tommaso "iomso" Cavallini

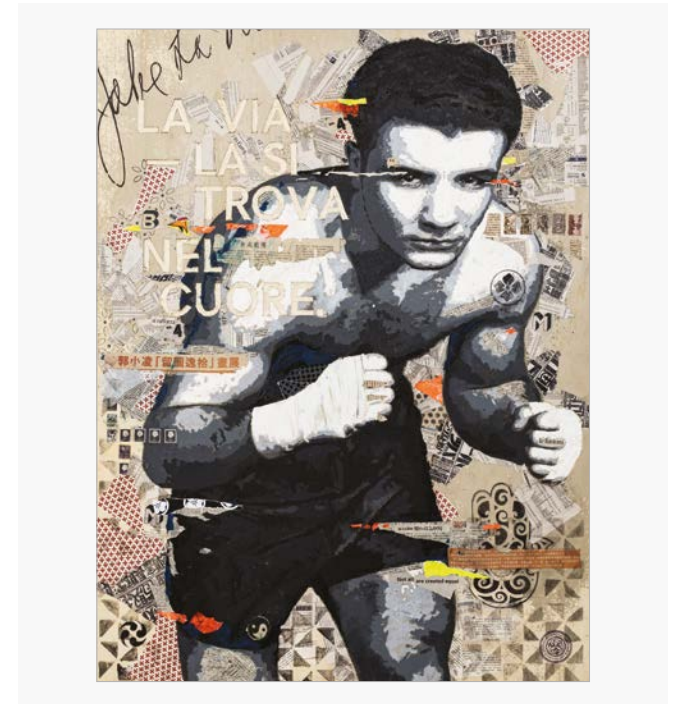

TC-002

Artist: Tommaso "iomso" Cavallini

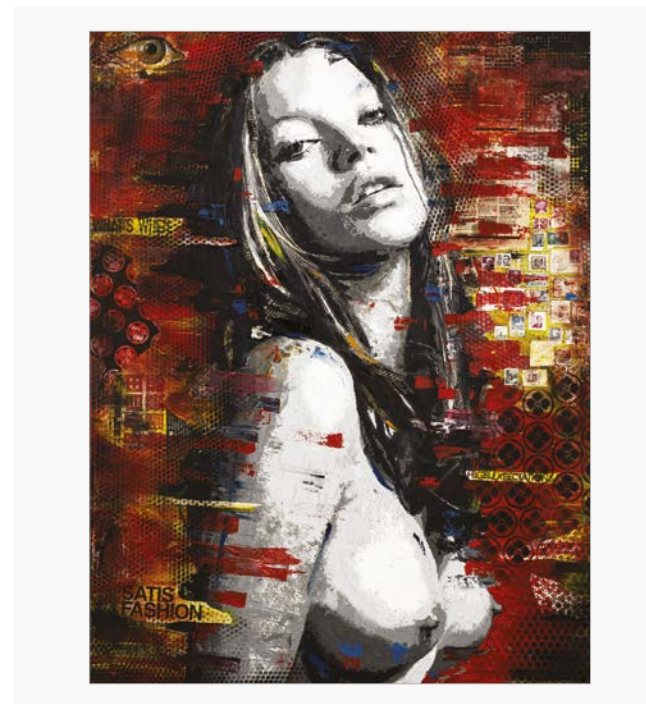

TC-003

Artist: Tommaso "iomso" Cavallini



TC-004

Artist: Tommaso "iomso" Cavallini



TC-005

Artist: Tommaso "iomso" Cavallini

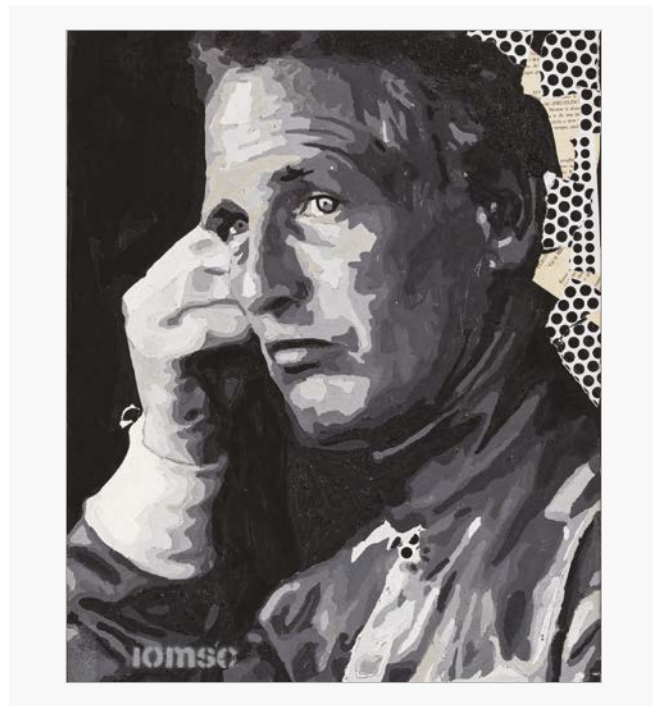

TC-006

Artist: Tommaso "iomso" Cavallini



TC-007

Artist: Tommaso "iomso" Cavallini



TC-008



Alessandro Corina

Alessandro Corina, classe 1988, è un designer di prodotti e un progettista di interni con sede a Grosseto. Il suo è un design emozionale ed estetico, Alessandro vuole stupire ed entrare in empatia con l'interlocutore. I suoi oggetti trasmettono un forte impatto sensoriale, emozionano. Nel 2018 la sua Home Studio viene selezionata tra i migliori progetti nell'ambito di Best Italian Interior Design Selection di Platform e esposta sia alla Triennale di Milano che negli Stati Uniti durante l'evento Archweek di Miami. Nel 2019 il divano Evergreen, ideato per l'azienda Gobbo Salotti, viene scelto per l'allestimento dell'ottava edizione di MasterChef Italia. Nei suoi progetti traspare il forte legame con la natura, ricorrono immagini ancestrali, potenti, che hanno lo scopo di riscoprire la vera umanità. Per Alessandro il design è anche uno strumento sociale, tanto che nel febbraio del 2020 viene selezionato tra i 2mila imprenditori ed economisti under 35 ed ha partecipato a Economy of Francesco, evento voluto dal Papa per progettare un'economia più giusta, fraterna e sostenibile.

/ Alessandro Corina, born in 1988, is a product designer and interior designer based in Grosseto. His is an emotional and aesthetic design, Alessandro wants to amaze and empathize with the interlocutor. His objects transmit a strong sensory impact, they excite. In 2018, his Home Studio was selected among the best projects within the Best Italian Interior Design Selection of Platform and exhibited both at the Milan Triennale and in the United States during the Archweek event in Miami. In 2019, the Evergreen sofa, designed for the Gobbo Salotti company, was chosen for the layout of the eighth edition of MasterChef Italia. In his projects, the strong bond with nature shines through, ancestral, powerful images recur, which aim to rediscover true humanity. For Alessandro, design is also a social tool, so much so that in February 2020 he was selected among the 2,000 entrepreneurs and economists under 35 and participated in Economy of Francesco, an event wanted by the Pope to plan a more just, fraternal and sustainable economy.

Artist: Alessandro Corina

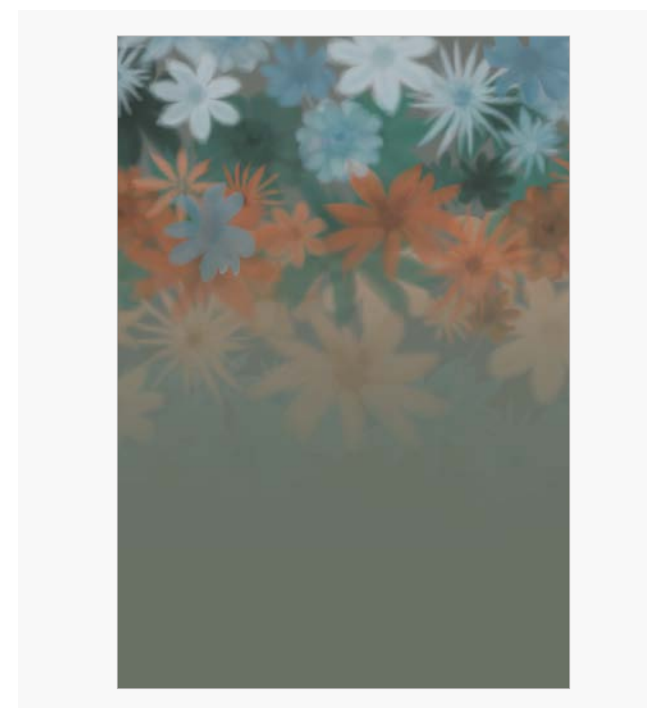

AC-001

Artist: Alessandro Corina

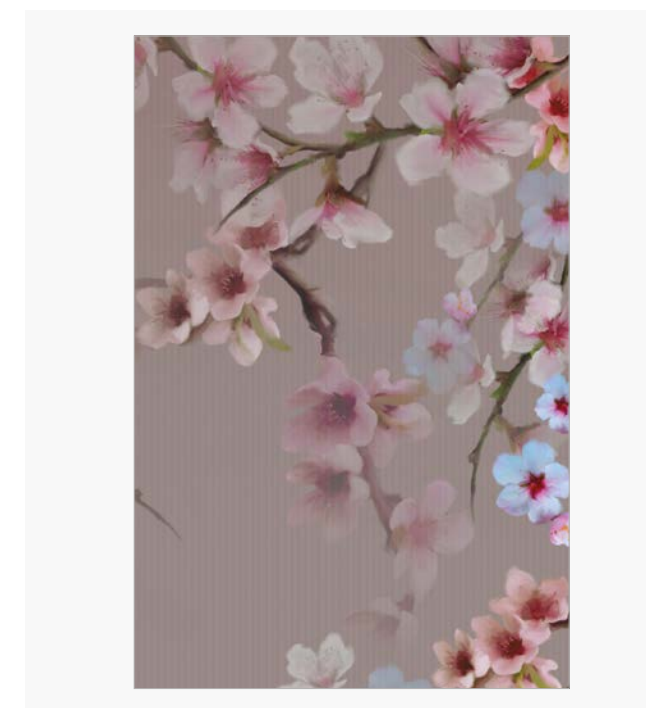

AC-002

Artist: Alessandro Corina

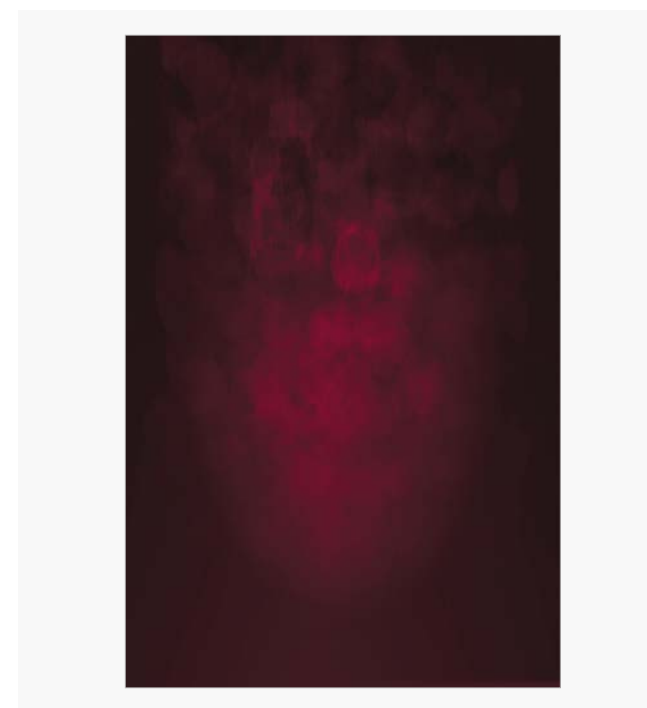

AC-003

Artist: Alessandro Corina

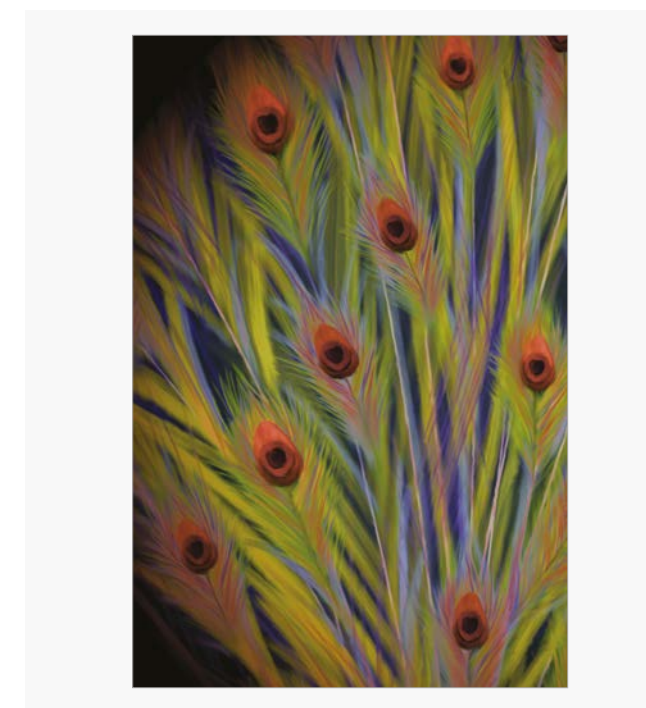

AC-004

Artist: Alessandro Corina

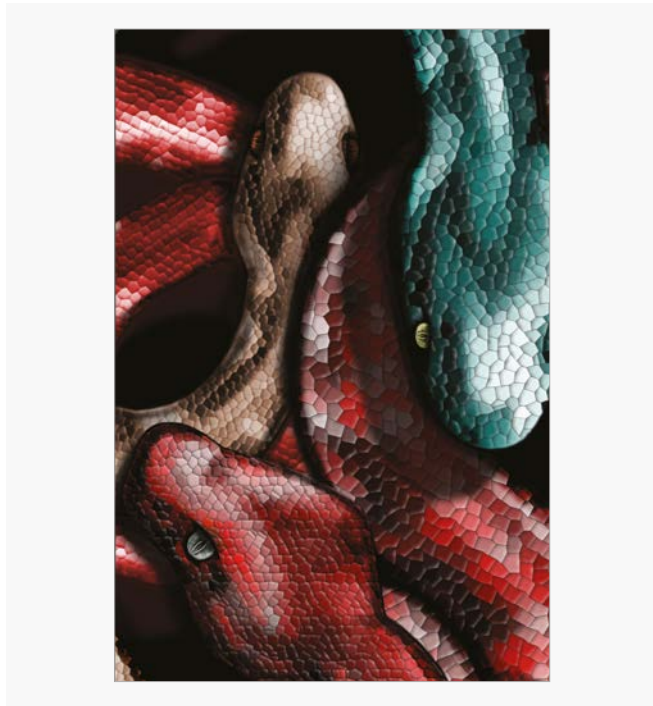

AC-005

Artist: Alessandro Corina

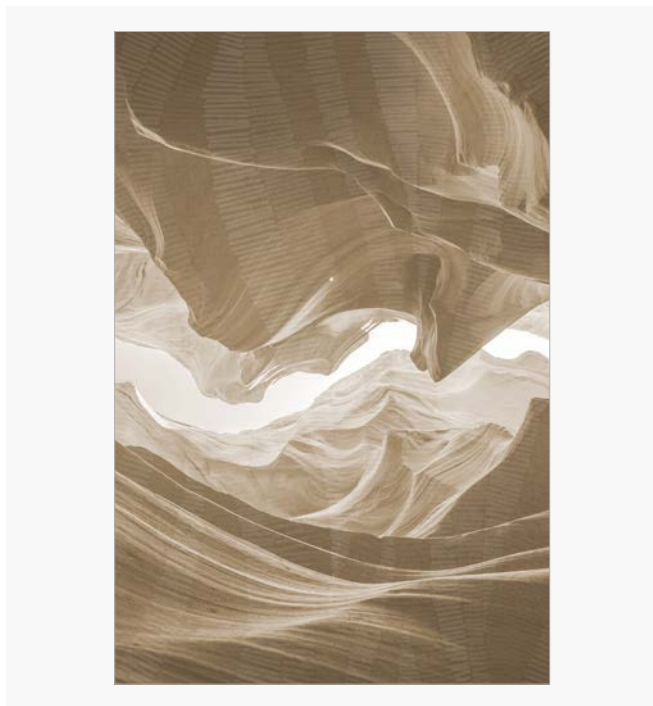

AC-007

Artist: Alessandro Corina



AC-006

Artist: Alessandro Corina



AC-008



Rosso Emerald Crimson (Rosso Artist)

Nata in Italia, Rosso vive e lavora a Londra dal 2004. Ha conseguito un Master in Comunicazione Internazionale e Diritti Umani presso la City University di Londra (Regno Unito) e ha lavorato nel marketing e nella pubblicità prima di cambiare direzione di carriera verso le arti visive. Il suo lavoro è stato presentato in Colossal, Evolved Mag, MyModernMet, Artists&Illustrator; The Artist's Magazine, ecc. e sulla copertina di Arena Magazine (Australia) ed è attualmente conservato in collezioni private in tutto il mondo. Attualmente è rappresentata da Sugarlift (New York, USA) e ZebraOne (Londra, Regno Unito). Finalista al "Beautiful Bizarre Art Prize" 2021; vincendo il "Jackson Open Painting Prize 2019 (JOPP2019)" per la categoria Ritratto/Figura; il "The Harbour Gallery Award" e il "The Artist's Exhibition Award" (TALP Open 2019); "The Holly Bush Emerging Woman Painter Prize 2017" e "Emerald Winter Pride Art Award" nel 2016. Nella sua ritrattistica, l'artista londinese Rosso Emerald Crimson rende soggetti femminili che emergono attraverso una foschia di pastelli e toni tenui. Le questioni di giustizia razziale, disuguaglianza di genere e crisi ambientale hanno tutte svolto un ruolo importante nel suo recente lavoro. Infonde risposte ad affari attuali e domande sul futuro, che spesso fungono da catalizzatore per i suoi progetti.

/ Born in Italy, Rosso has lived and worked in London since 2004. She holds a Masters in International Communication and Human Rights from City University of London (UK) and worked in marketing and advertising before changing career direction to the arts. visual. His work has been featured in Colossal, Evolved Mag, MyModernMet, Artists & Illustrator; The Artist's Magazine, etc. and on the cover of Arena Magazine (Australia) and is currently held in private collections around the world. It is currently represented by Sugarlift (New York, USA) and ZebraOne (London, UK). Finalist at the "Beautiful Bizarre Art Prize" 2021; winning the "Jackson Open Painting Prize 2019 (JOPP2019)" for the Portrait / Figure category; the "The Harbor Gallery Award" and the "The Artist's Exhibition Award" (TALP Open 2019); "The Holly Bush Emerging Woman Painter Prize 2017" and "Emerald Winter Pride Art Award" in 2016. In his portraiture, the London-based artist Rosso Emerald Crimson renders female subjects that emerge through a haze of pastels and muted tones. Issues of racial justice, gender inequality and the environmental crisis have all played an important role in his recent work. He instills answers to current affairs and questions about the future, which often act as a catalyst for his projects.

Artist: Rosso Emerald Crimson

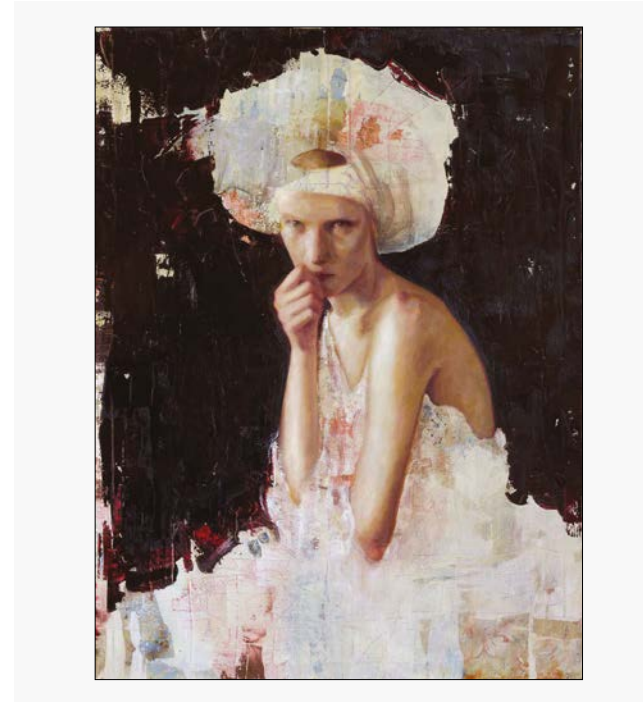

RA-001

Artist: Rosso Emerald Crimson

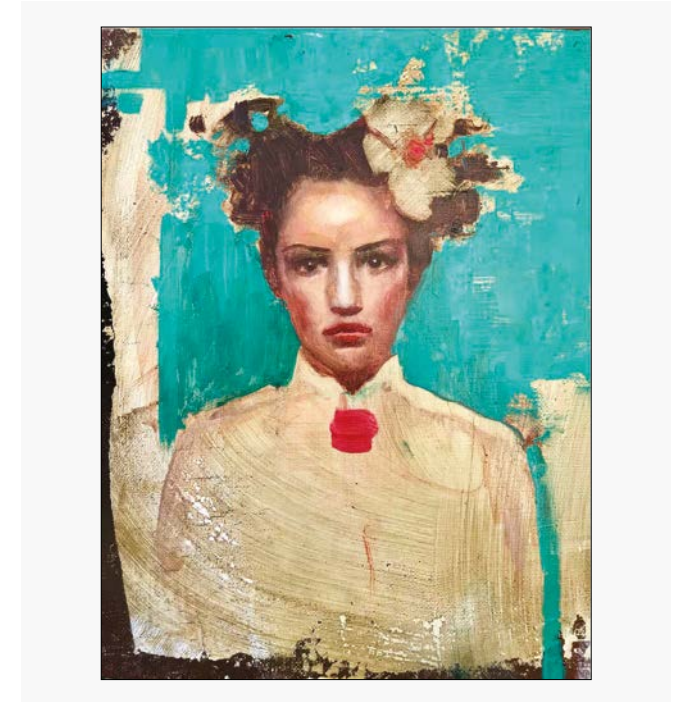

RA-002

Artist: Rosso Emerald Crimson

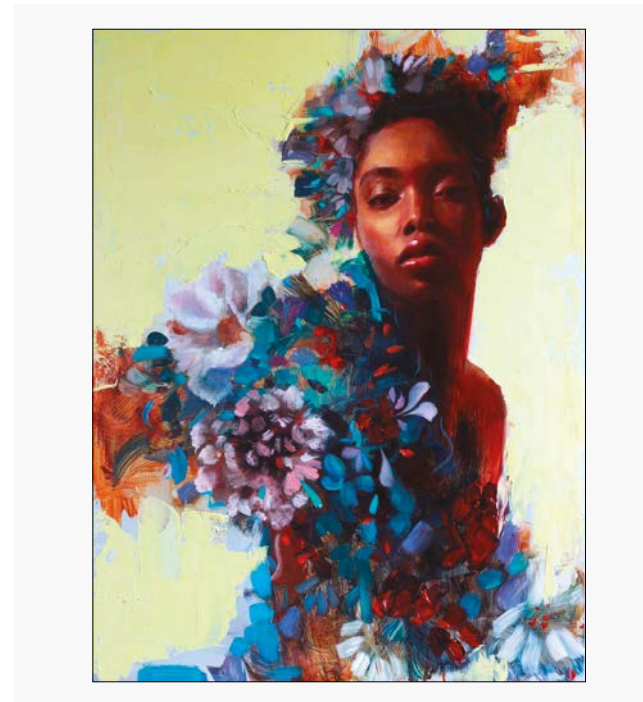

RA-003

Artist: Rosso Emerald Crimson



RA-004

Artist: Rosso Emerald Crimson

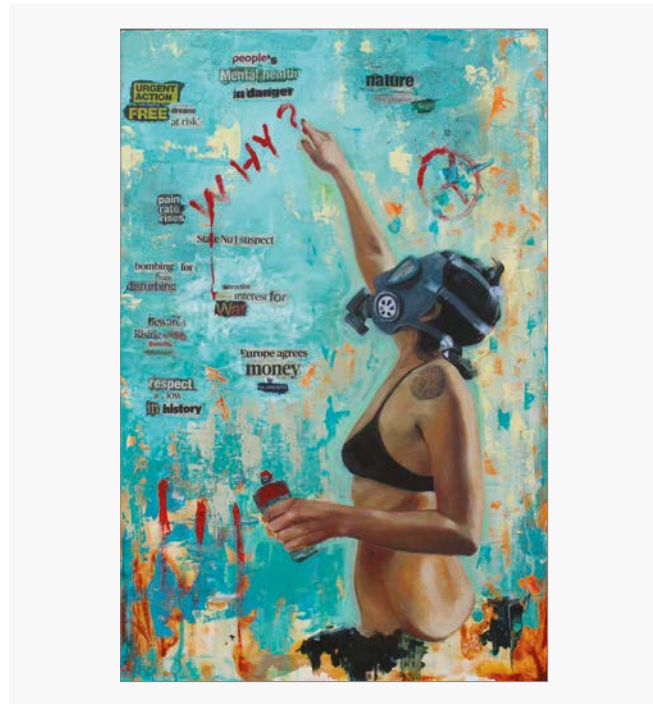

RA-005

Artist: Rosso Emerald Crimson



RA-007

Artist: Rosso Emerald Crimson

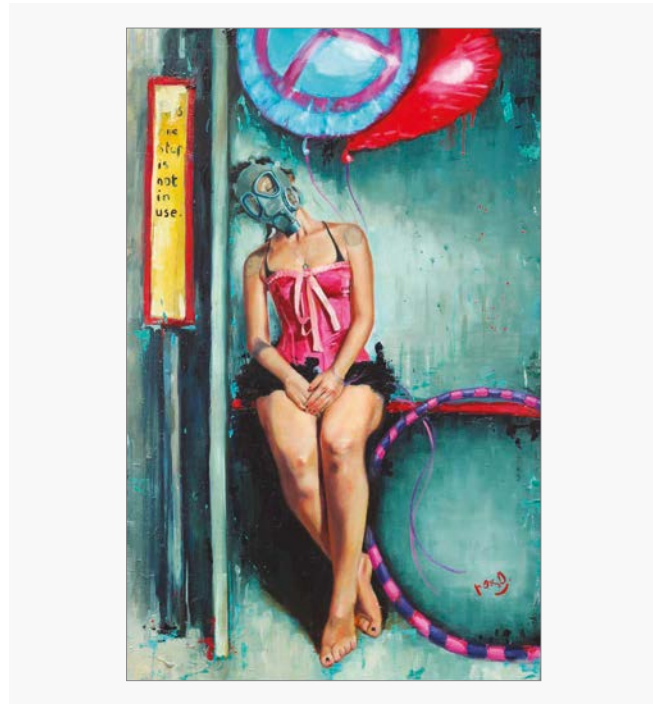

RA-006

Artist: Rosso Emerald Crimson



RA-008



Enrico De Luigi

Ritrattista e fotografo di scena, Enrico De Luigi, in arte Chico, è nato a Rimini nel 1966. Ha iniziato la sua carriera a Milano alla fine degli anni '80 e ha collaborato con le più prestigiose riviste nazionali e internazionali come GQ, Vanity Fair, Rolling Stone, Riders, Sportweek. Ha vinto premi (come quello per la miglior fotografia di scena attribuito a uno scatto sul set di *Caos calmo*, un intenso bianco e nero con Nanni Moretti e Valeria Golino), fotografato in Polaroid 50x60 attori e registi ai Festival di Venezia e Berlino, collabora da anni con la Fandango (ha da poco terminato *L'ultimo terrestre*, esordio cinematografico del fumettista Gipi che sarà presentato al prossimo Festival di Venezia). Ha lavorato come operatore super 8 a "Super 8 stories" di Emir Kusturica, il documentario con le gesta della rock band del regista. L'interesse e la curiosità per l'espressione umana hanno portato Enrico a esplorare costantemente altri mondi con occhio antropologico: espressione naturalistica di grande impatto che rivela un significato più profondo e una rivelazione naturale del soggetto stesso.

/ Portrait and still photographer Enrico De Luigi, aka Chico, was born in Rimini in 1966. He began his career in Milan in the late 1980s and has collaborated with the most prestigious national and international magazines such as GQ, Vanity Fair, Rolling Stone, Riders, Sportweek. He has won awards (such as the one for best stage photography attributed to a shot on the set of *Chaos calmo*, an intense black and white with Nanni Moretti and Valeria Golino), photographed in Polaroid 50 x 60 actors and directors at the Venice and Berlin Festivals, has been collaborating for years with Fandango (he has just finished *L'ultimo terrestre*, the film debut of the cartoonist Gipi which will be presented at the next Venice Film Festival). He worked as super 8 operator on Emir Kusturica's "Super 8 stories", the documentary featuring the exploits of the director's rock band. The interest and curiosity for human expression led Enrico to constantly explore other worlds with an anthropological eye: a naturalistic expression of great impact that reveals a deeper meaning and a natural revelation of the subject itself.

Artist: Enrico De Luigi

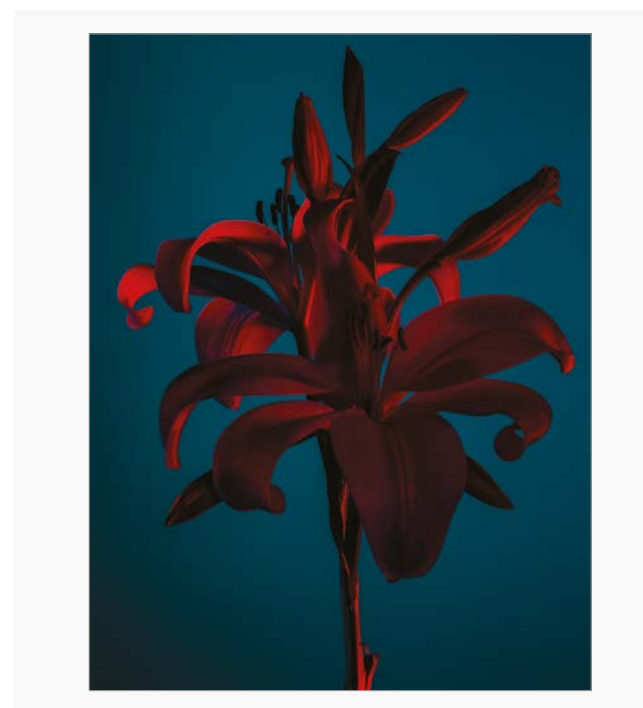

ED-001

Artist: Enrico De Luigi

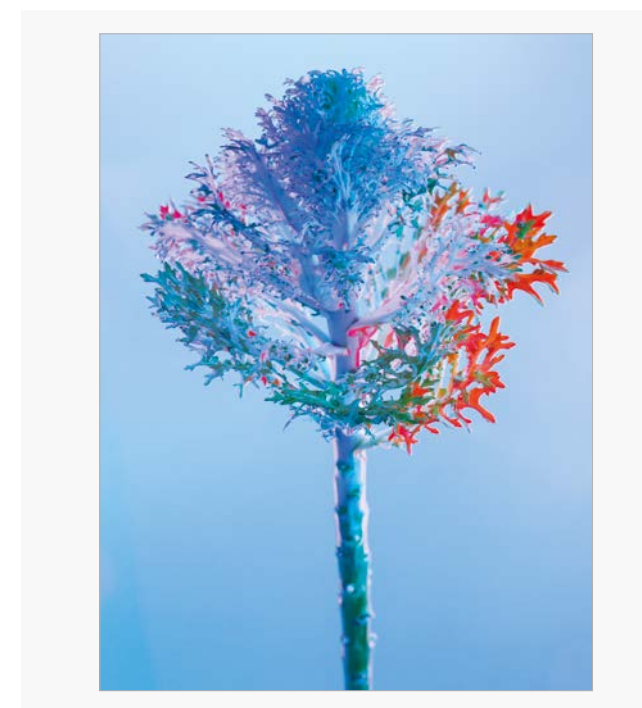

ED-002

Artist: Enrico De Luigi

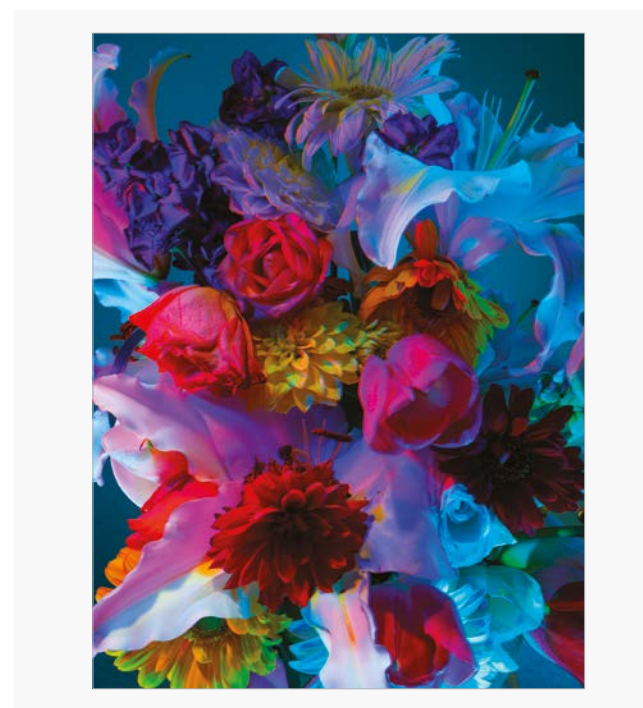

ED-004

Artist: Enrico De Luigi

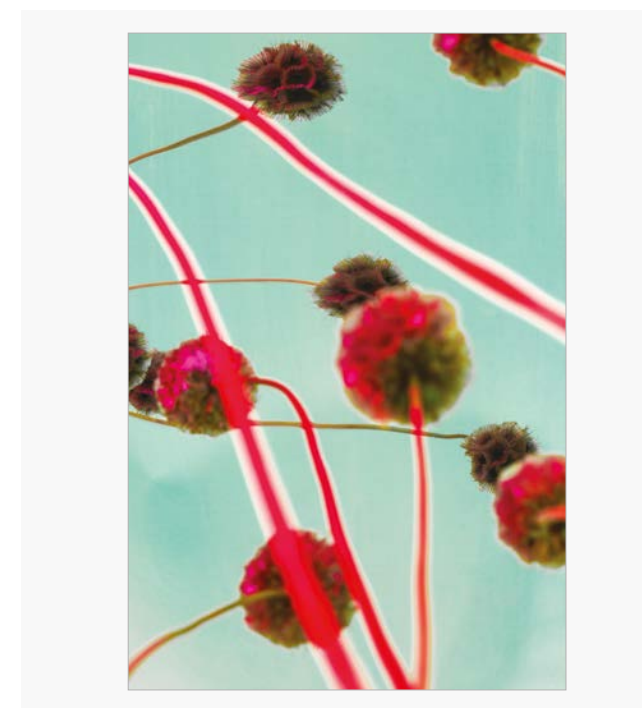

ED-005

Artist: Enrico De Luigi

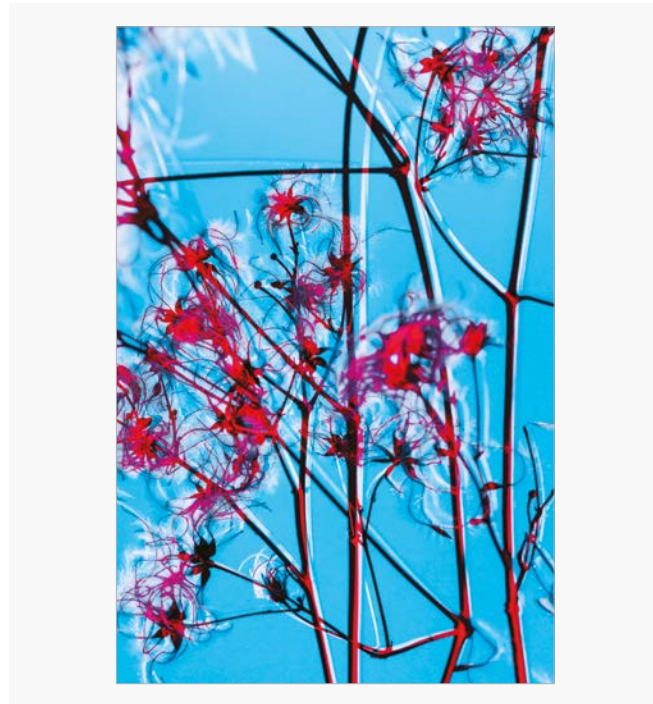

ED-006

Artist: Enrico De Luigi

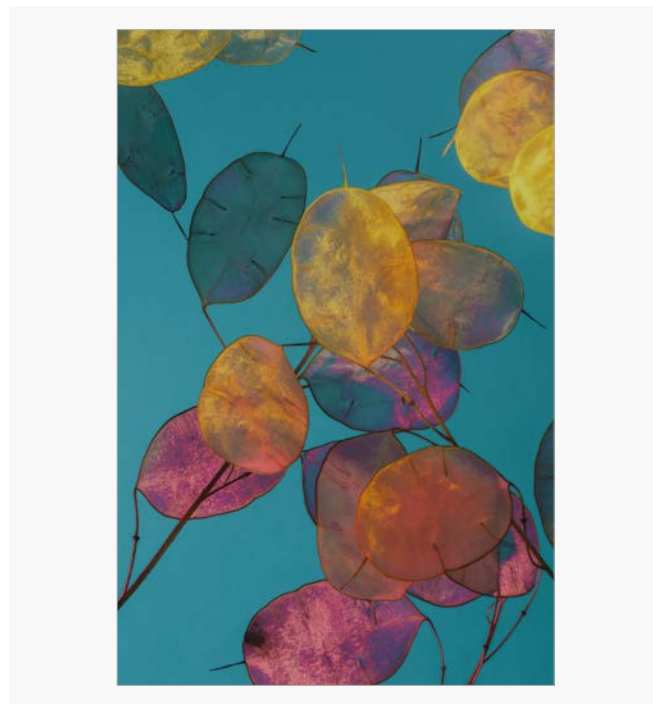

ED-008

Artist: Enrico De Luigi

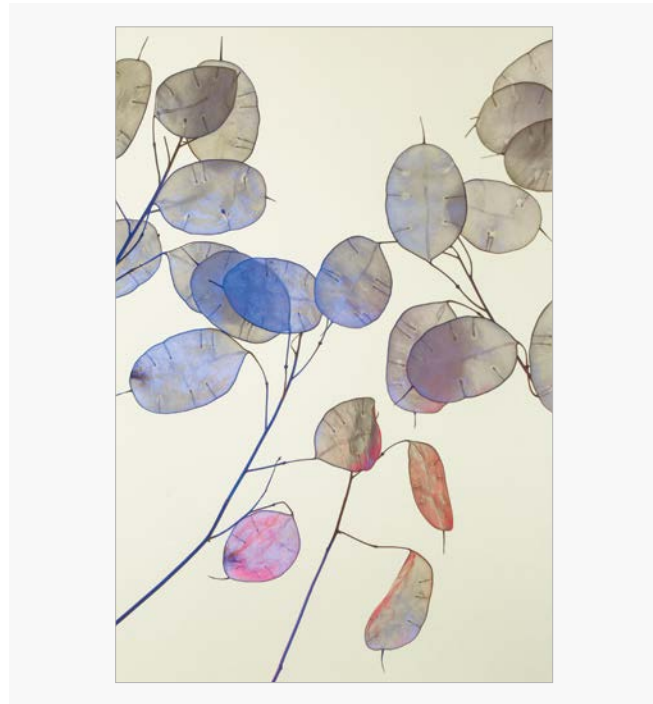

ED-007

Artist: Enrico De Luigi

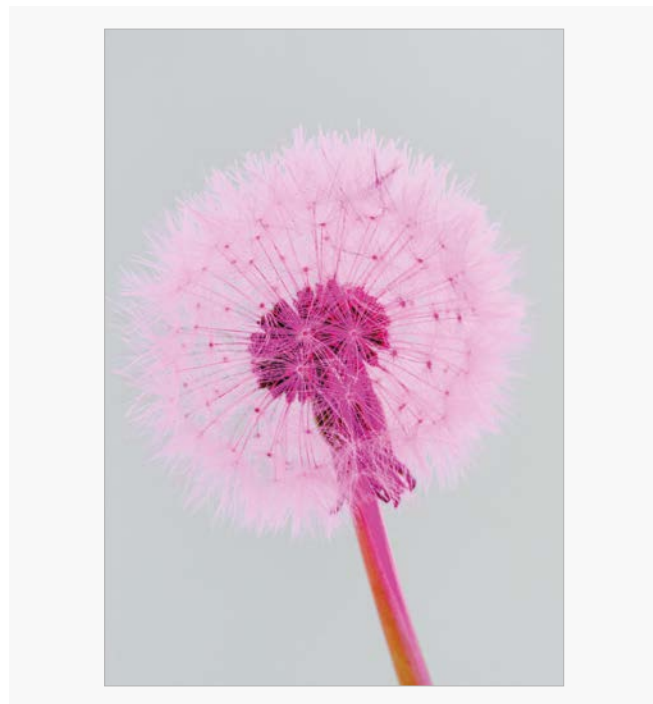

ED-009



Artist: Enrico De Luigi

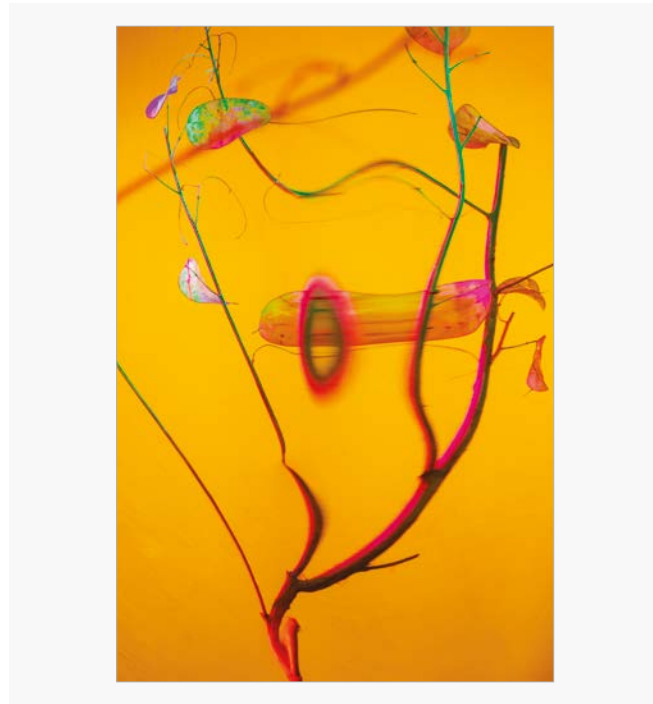

ED-011

Artist: Enrico De Luigi

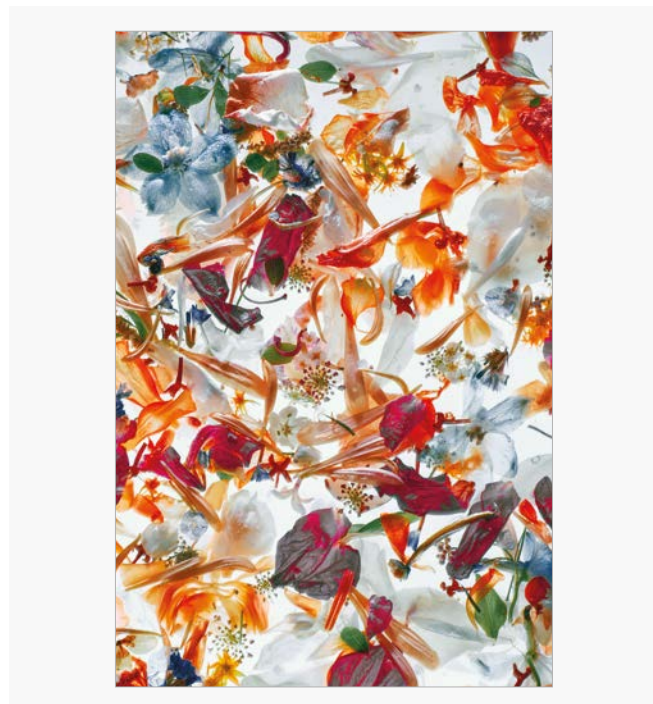

ED-018

Artist: Enrico De Luigi

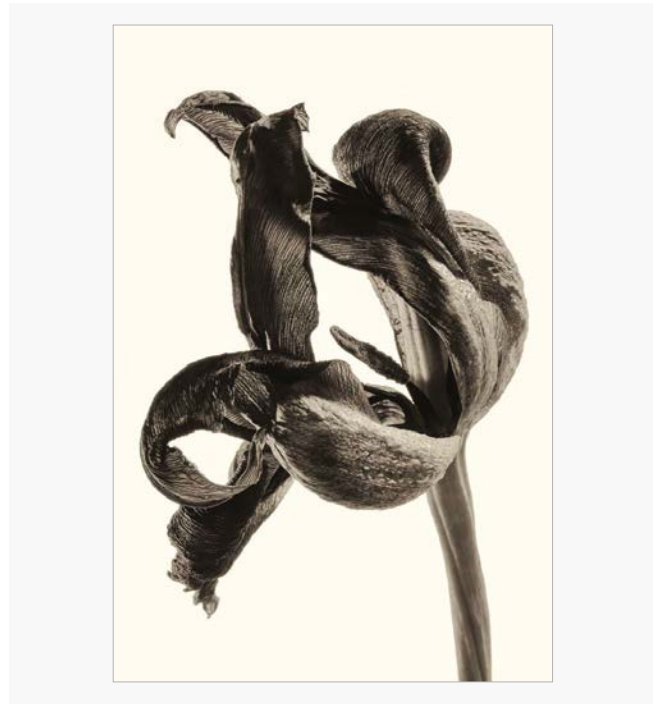

ED-017

Artist: Enrico De Luigi

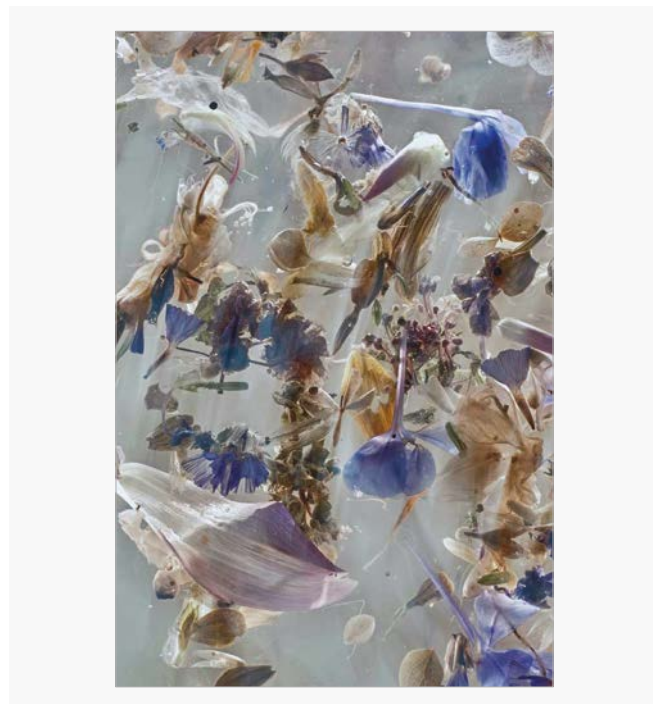

ED-019



Artist: Enrico De Luigi

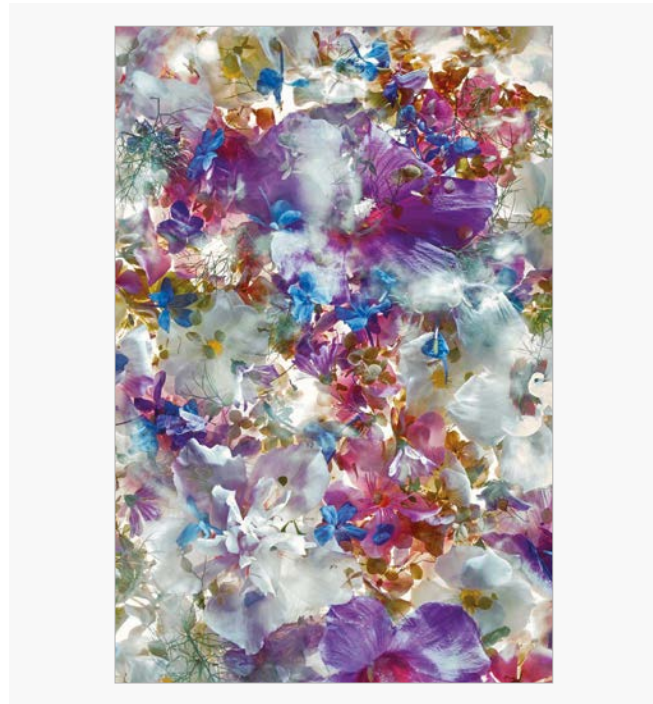

ED-020

Artist: Enrico De Luigi

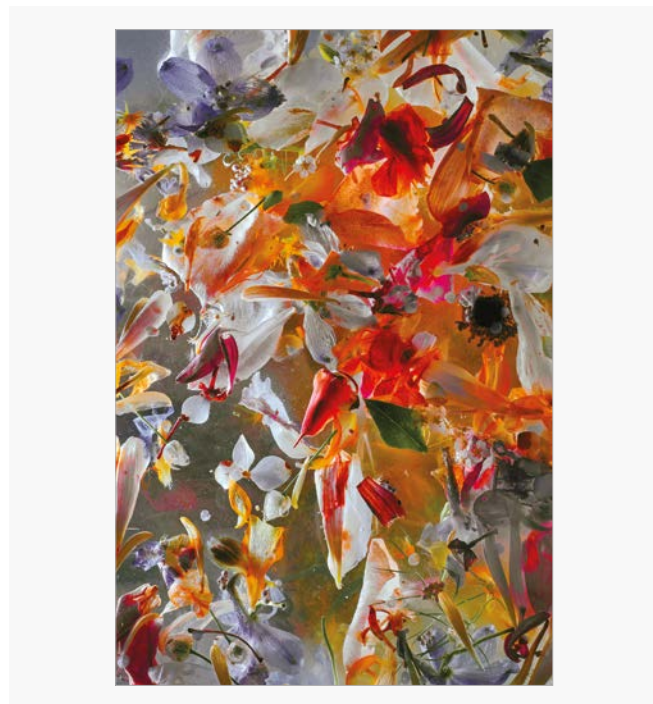

ED-022

Artist: Enrico De Luigi

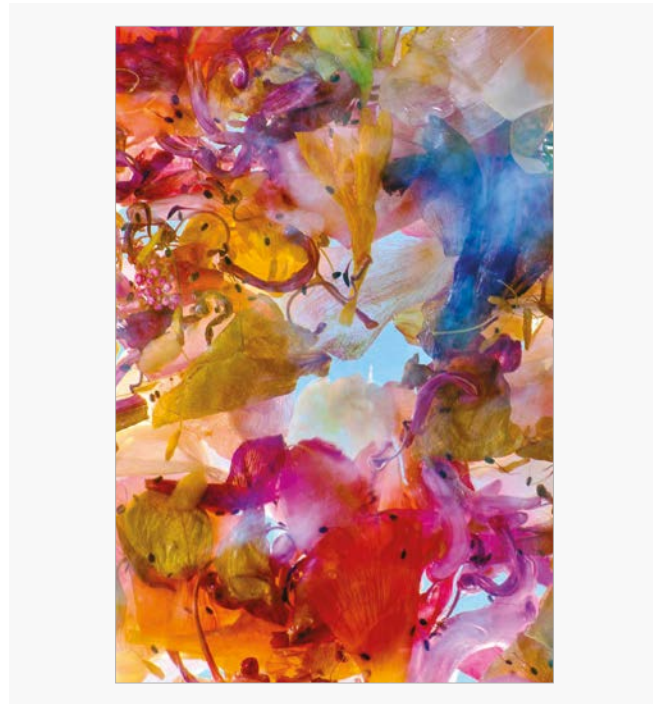

ED-021

Artist: Enrico De Luigi

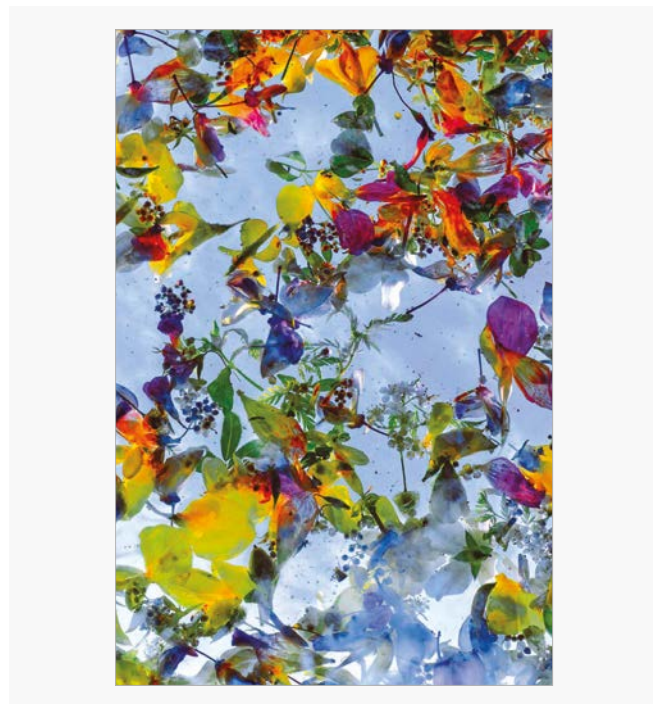

ED-023



Shirin Donia

Artist: Shirin Donia

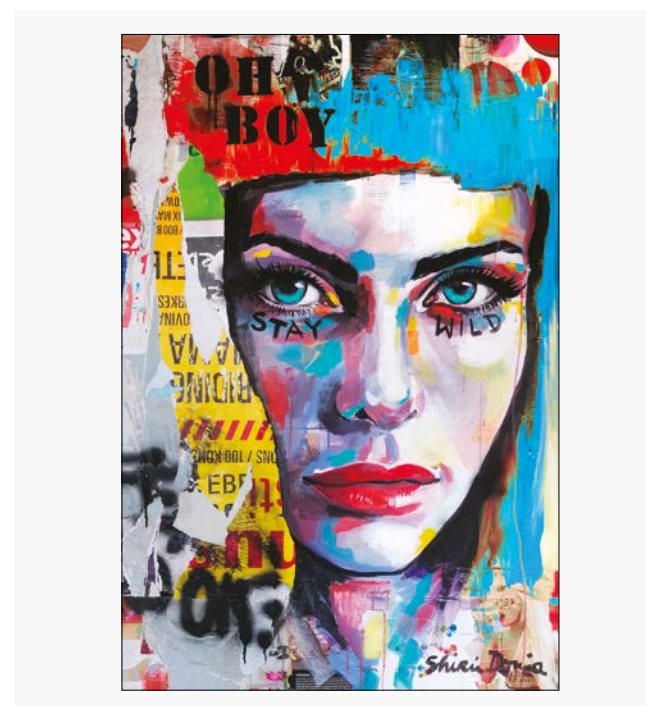

DO-001

Artist: Shirin Donia

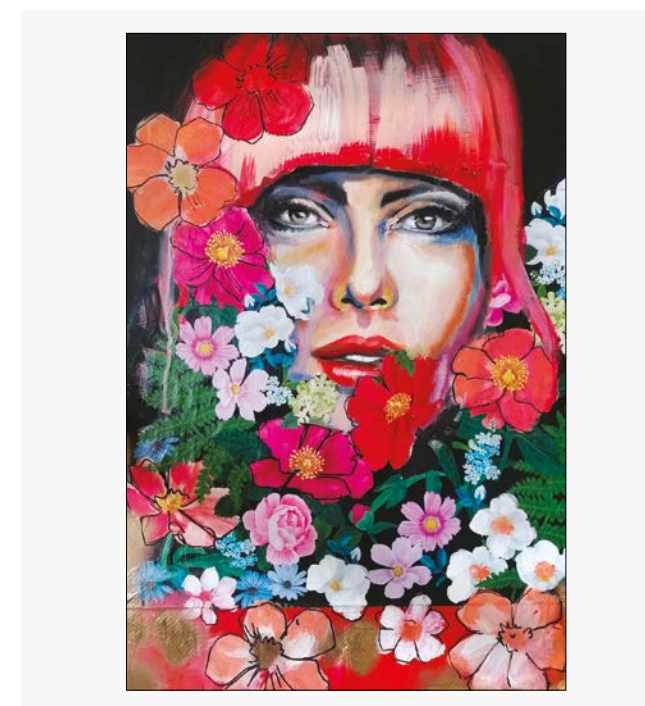

DO-002

Artist: Shirin Donia

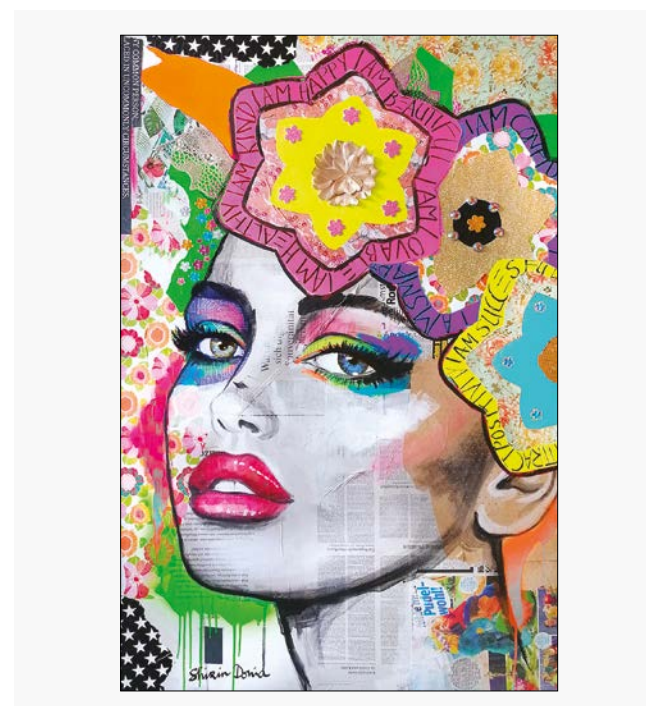

DO-003

Artist: Shirin Donia

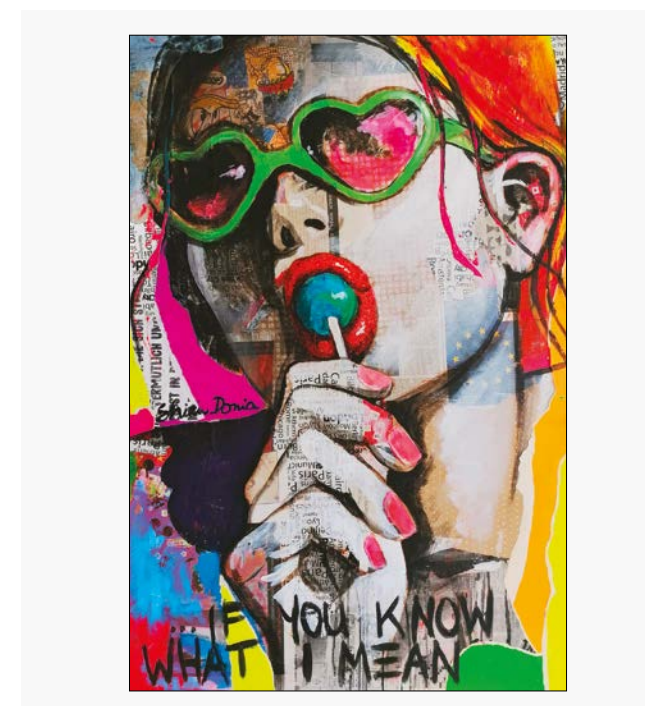

DO-004

Anche se la creatività è la parte principale del suo "lavoro", la sua esistenza artistica non si limita a questo. Oltre ad essere un artista, si vede anche come un fornitore di servizi creativi per tutto ciò che ha a che fare con l'arte e vive il suo lavoro in modo libero e flessibile. Disegna regolarmente prodotti di merchandising, crea calendari o conduce laboratori artistici. Questa diversità nell'esercizio della sua attività artistica le consente non solo di essere creativa nella realizzazione delle sue opere d'arte, ma anche di diversificare la mia vita quotidiana. Cresciuta in Germania, ha vissuto la sua infanzia a Neu-Isenburg, vicino a Francoforte sul Meno, ama qualsiasi forma di design, artigianato e interior design.

/ Although creativity is the main part of his "work", his artistic existence is not limited to this. In addition to being an artist, he also sees himself as a creative service provider for everything that has to do with art and lives his work in a free and flexible way. He regularly designs merchandise products, creates calendars or conducts art workshops. This diversity in the exercise of her artistic activity allows her not only to be creative in the creation of her works of art, but also to diversify my daily life. Raised in Germany, she lived her childhood in Neu-Isenburg near Frankfurt am Main, she loves all forms of design, craftsmanship and interior design.

Artist: Shirin Donia

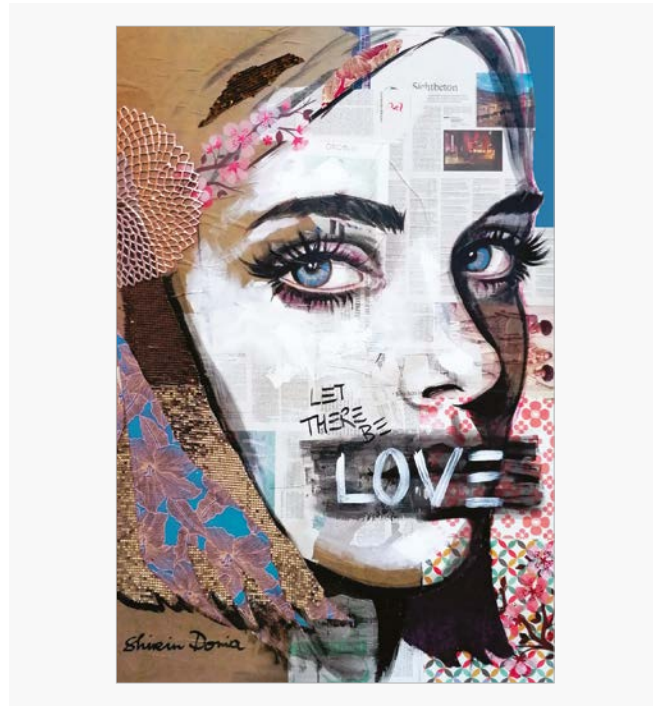

DO-005

Artist: Shirin Donia

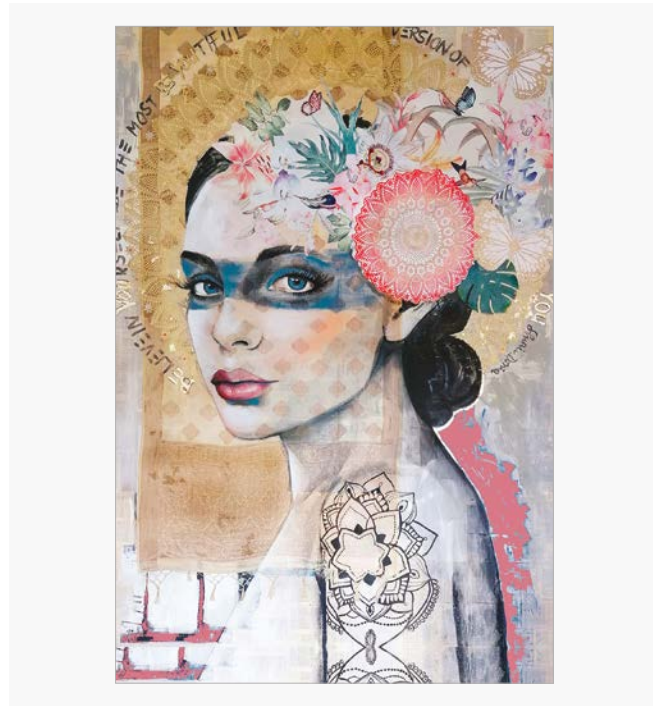

DO-006

Artist: Shirin Donia

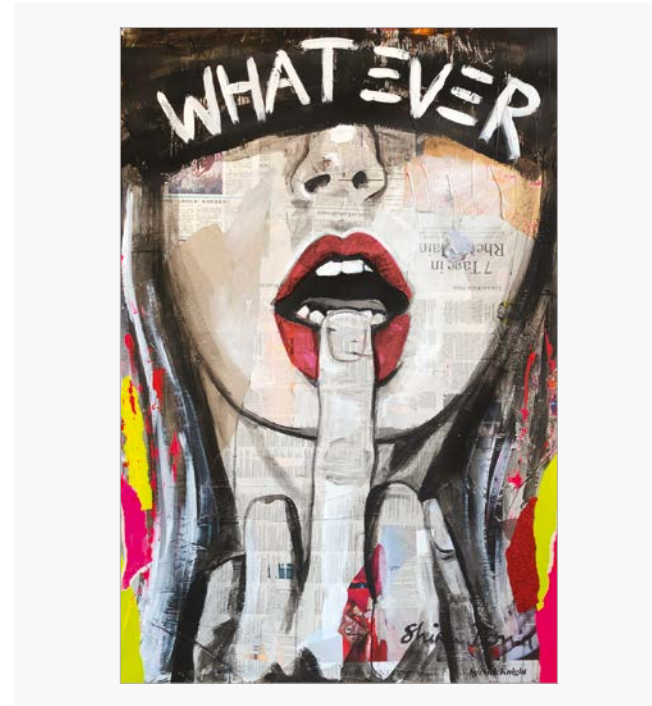

DO-009

Artist: Shirin Donia

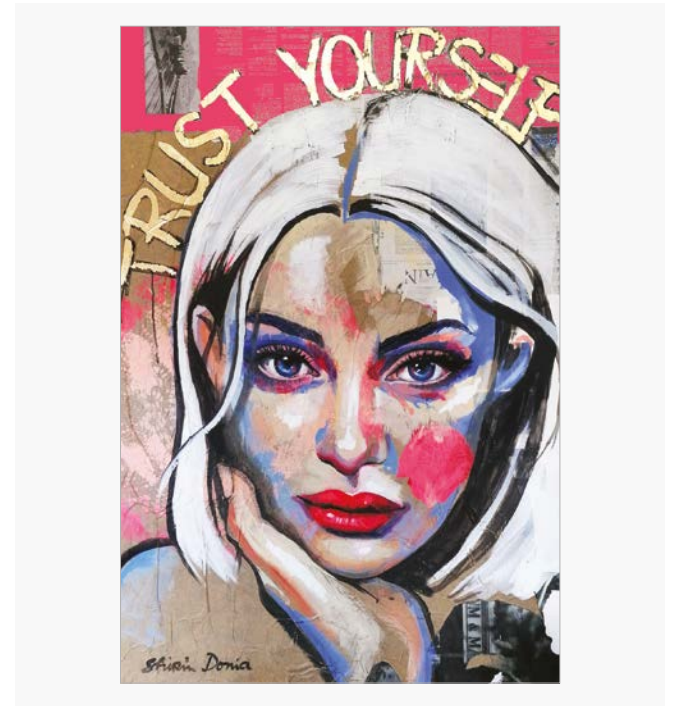

DO-010

Artist: Shirin Donia

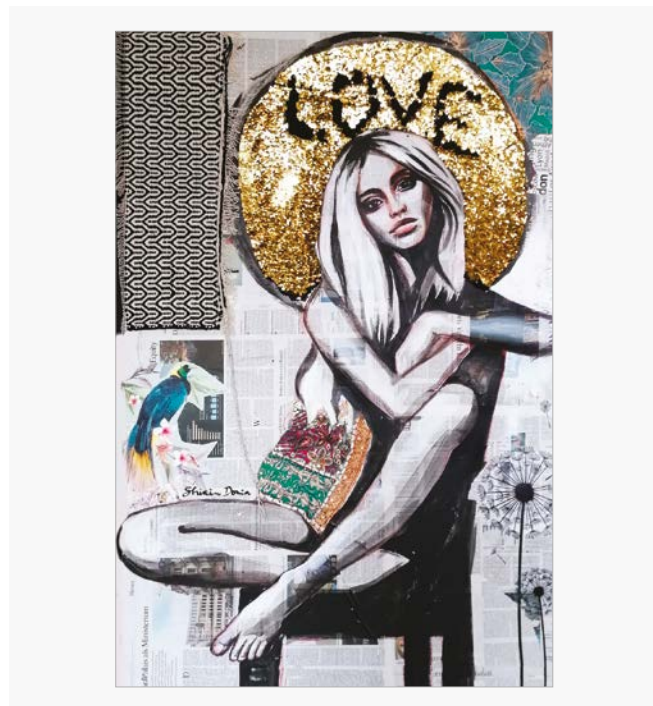

DO-007

Artist: Shirin Donia



DO-008

Artist: Shirin Donia

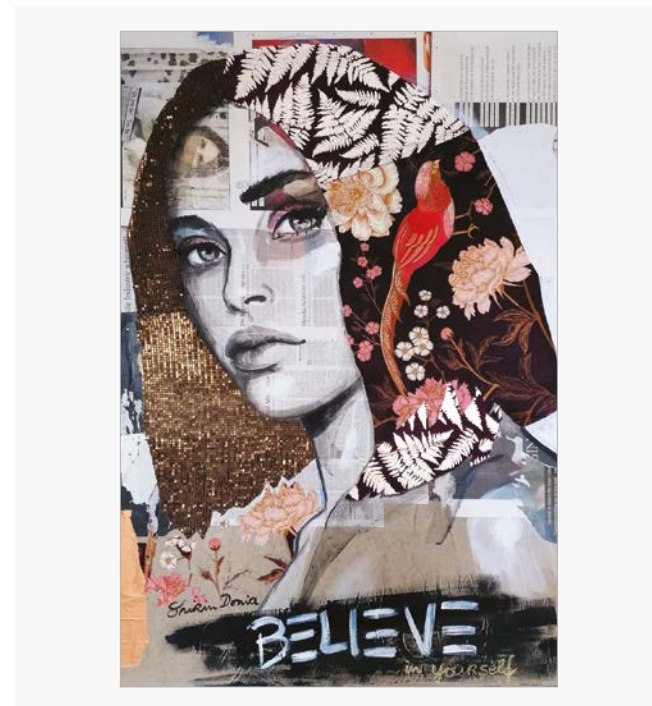

DO-011

Artist: Shirin Donia

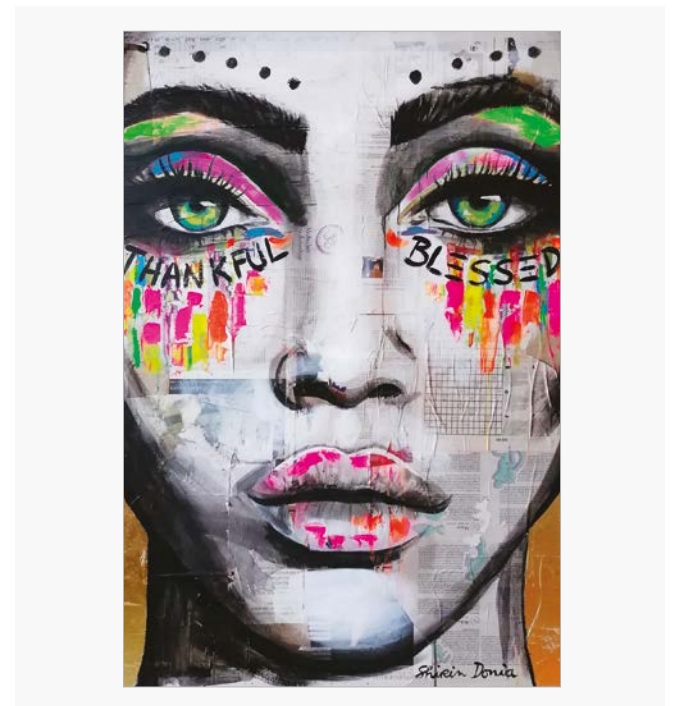

DO-012

Artist: Shirin Donia

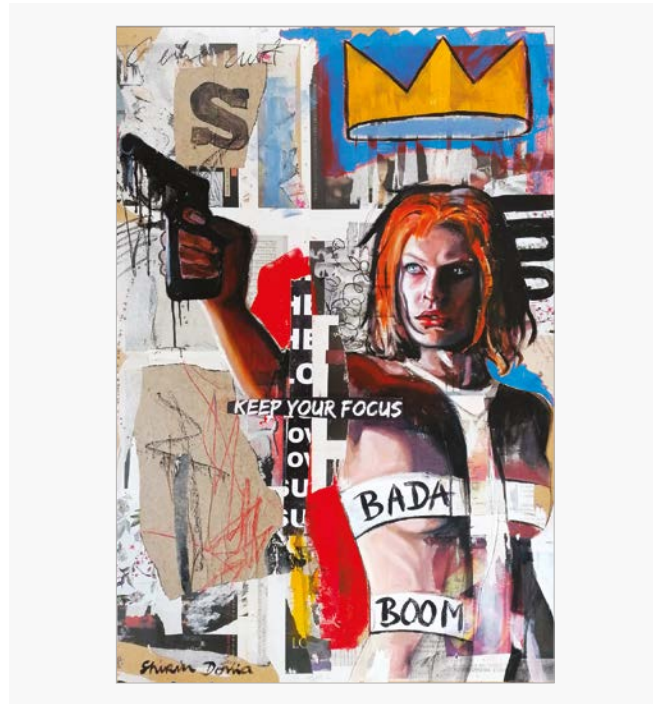

DO-013

Artist: Shirin Donia

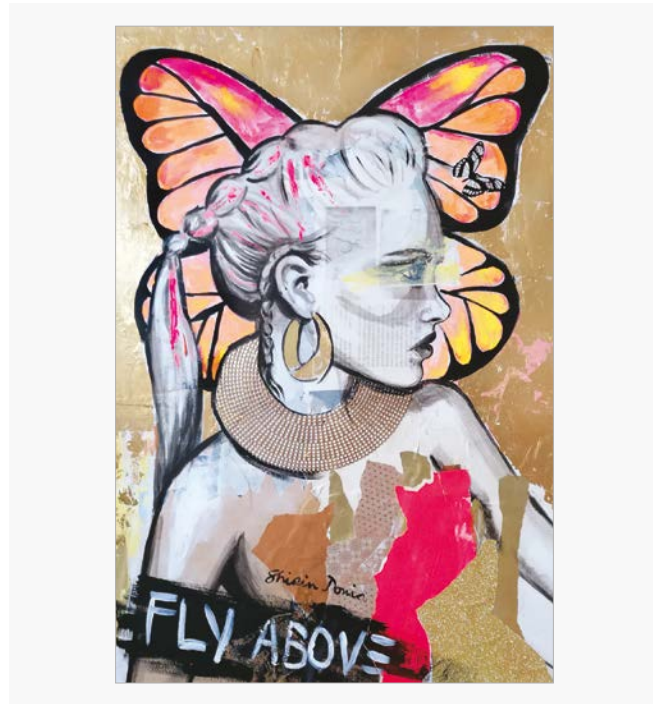

DO-014

Artist: Shirin Donia

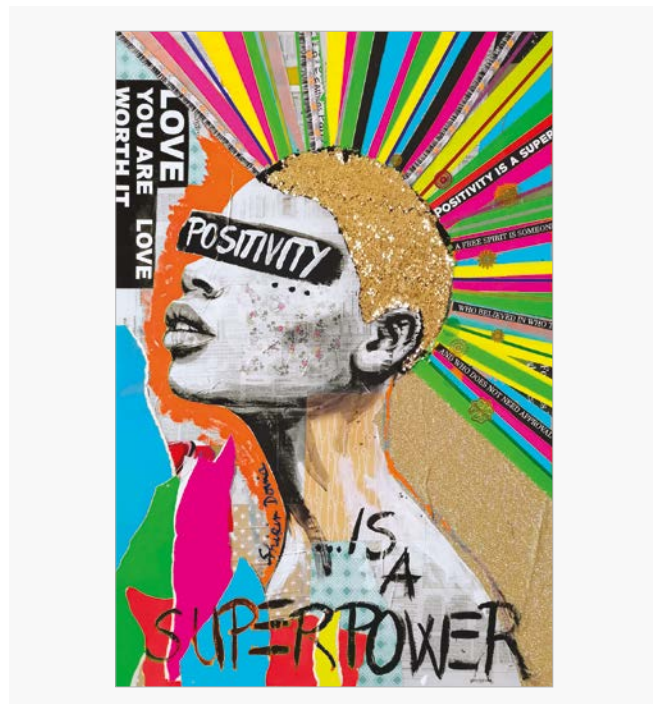

DO-015

Artist: Shirin Donia

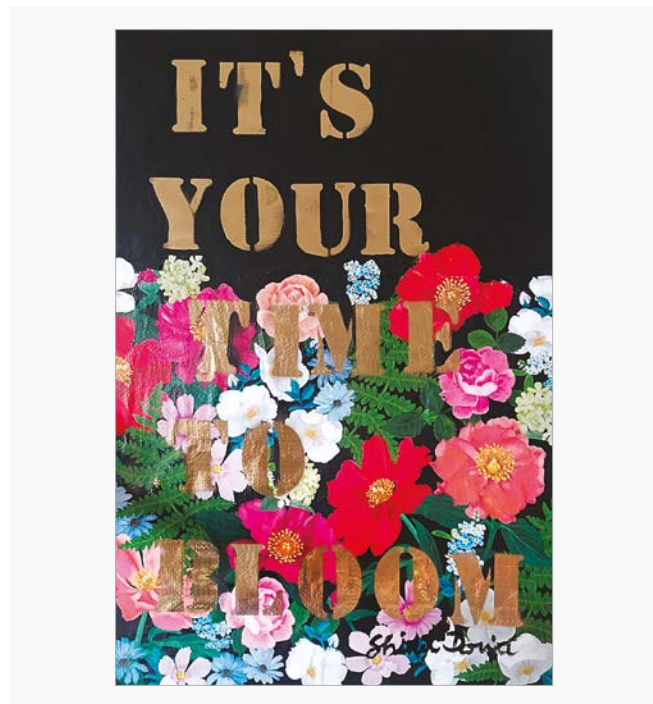

DO-016



Ivana Dostalova

Fotografa freelance ceca e artista visiva con sede a Praga, fondatrice e CEO di Voitopi Photography (fotografia fine-art, progetti commerciali e documentari). Nella fotografia d'arte, si dedica a esposizioni multiple e all'arte visiva, queste fotografie creano diverse grandi serie di poesie fiabesche che riflettono i problemi dei tempi odierni come l'anonimato, i social media ecc. (serie Ghosts, We Are All Dreamers, Lost in the City, Ricordi, ecc.), relazioni e personaggi (serie Relazioni, Metamorfosi, Ritratti di personaggi). A settembre 2018 sono state selezionate le collezioni Lost in the City e We Are All Dreamers per l'Other Art Fair al Mana Contemporary di Chicago. Ivana si dedica anche ai libri d'autore per bambini, nel 2018 ha pubblicato il suo secondo libro d'autore per bambini, in cui le esposizioni multiple fotografiche sono state utilizzate per la prima volta nel genere della letteratura per ragazzi (What is Princess Elly Sky Dreaming About). Ivana è anche autrice di più di 130 dipinti, che sono insieme alle fotografie rappresentate in collezioni private nella Repubblica Ceca, Berlino, Chicago, Atlanta, New York. Nel 2018 Ivana ha ricevuto una menzione d'onore al Bordeaux Art Limited Abstract Competition. Nel 2019, la sua fotografia della serie Metamorphosis (Finalmente gratuita) è stata selezionata per la Fine Art Gallery su Lens Culture web. Nel 2019, Ivana ha vinto il 2° posto al Czech Press Photo Competition nella categoria Portrait e nel 2020 il suo lavoro è stato selezionato per Los Angeles Other Art Fair. Il suo lavoro è stato più volte selezionato per il Frontespizio e la collezione Excellence di Art Limited France.

/ Czech freelance photographer and visual artist based in Prague, founder and CEO of Voitopi Photography (fine-art photography, commercial projects and documentaries). In art photography, she devotes herself to multiple exposures and visual art, these photographs create several large series of fairy tale poems that reflect the problems of today's times such as anonymity, social media etc. (Ghosts series, We Are All Dreamers, Lost in the City, Memories, etc.), relationships and characters (Relationships, Metamorphosis series, Portraits of characters). In September 2018, the Lost in the City and We Are All Dreamers collections were selected for the Other Art Fair at Mana Contemporary in Chicago. Ivana is also dedicated to children's author books, in 2018 she published her second children's author book, in which photographic multiple exposures were used for the first time in the genre of children's literature (What is Princess Elly Sky Dreaming About). Ivana is also the author of more than 130 paintings, which are together with photographs represented in private collections in the Czech Republic, Berlin, Chicago, Atlanta, New York. In 2018 Ivana received an honorable mention at the Bordeaux Art Limited Abstract Competition. In 2019, her photography from the Metamorphosis series (Finally Free) was selected for the Fine Art Gallery on Lens Culture web. In 2019, Ivana won 2nd place at the Czech Press Photo Competition in the Portrait category and in 2020 her work was selected for the Los Angeles Other Art Fair. Her work has been repeatedly selected for the Frontispiece and the Excellence collection by Art Limited France.

Artist: Ivana Dostalova

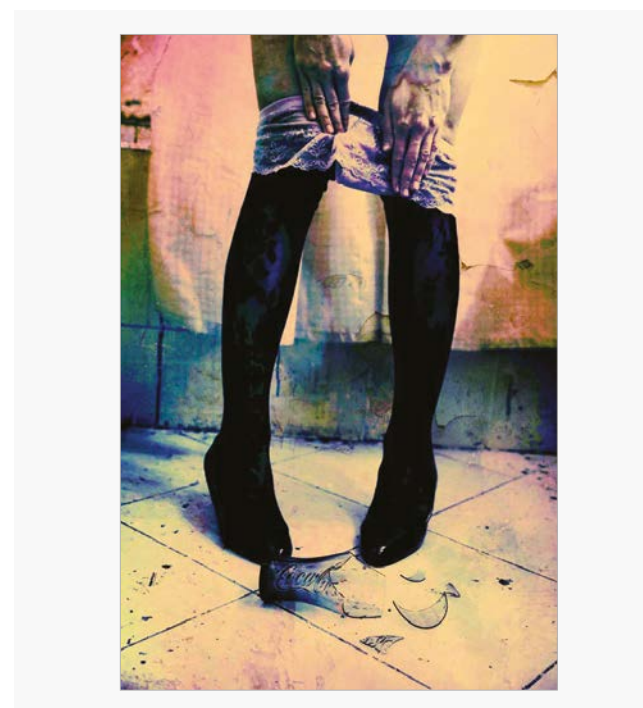

ID-001

Artist: Ivana Dostalova

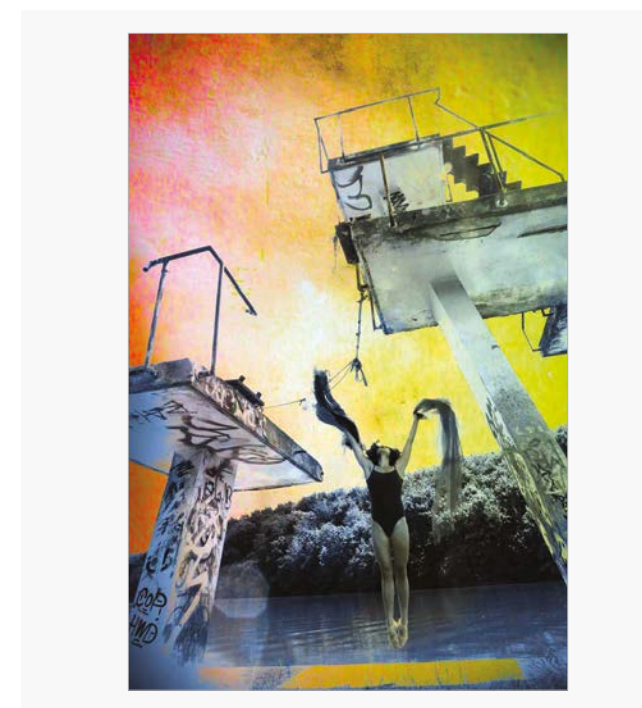

ID-002

Artist: Ivana Dostalova



ID-003

Artist: Ivana Dostalova

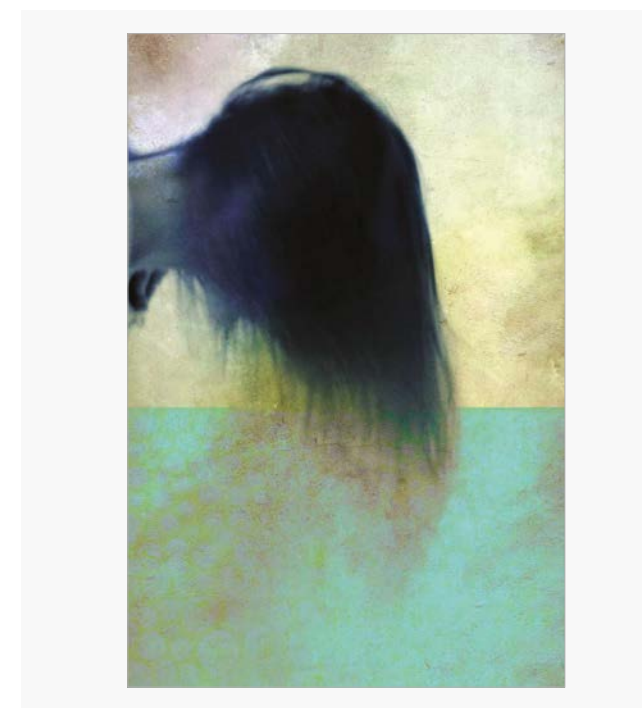

ID-004

Artist: Ivana Dostalova

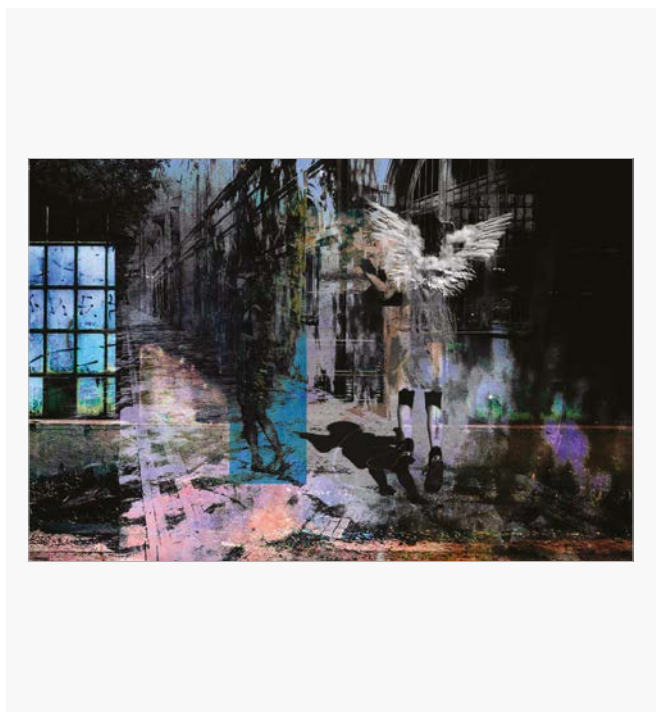

ID-005

Artist: Ivana Dostalova

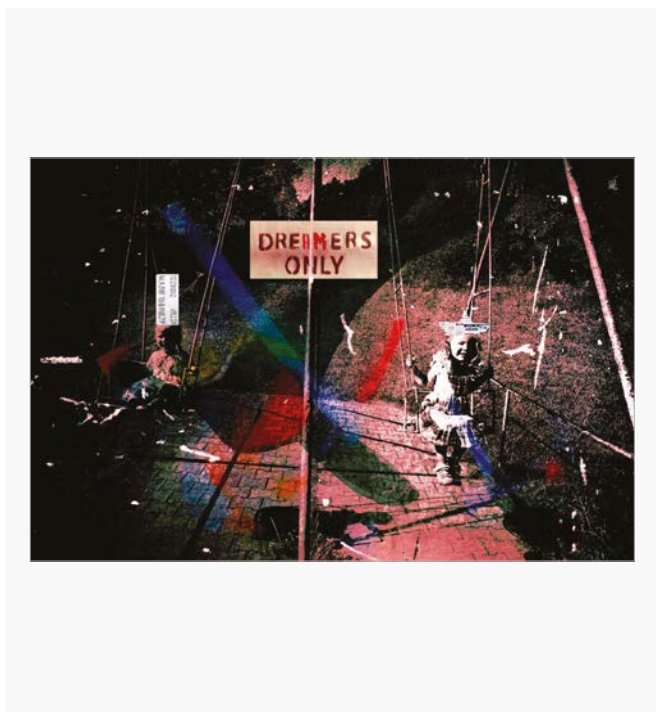

ID-007

Artist: Ivana Dostalova



ID-006

Artist: Ivana Dostalova



ID-008



Artist: Ivana Dostalova

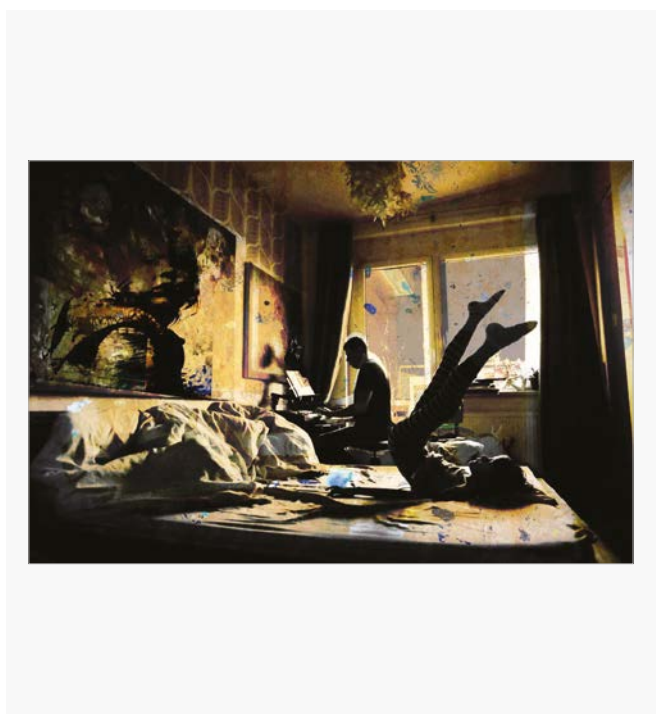

ID-009

Artist: Ivana Dostalova



ID-010

Artist: Ivana Dostalova

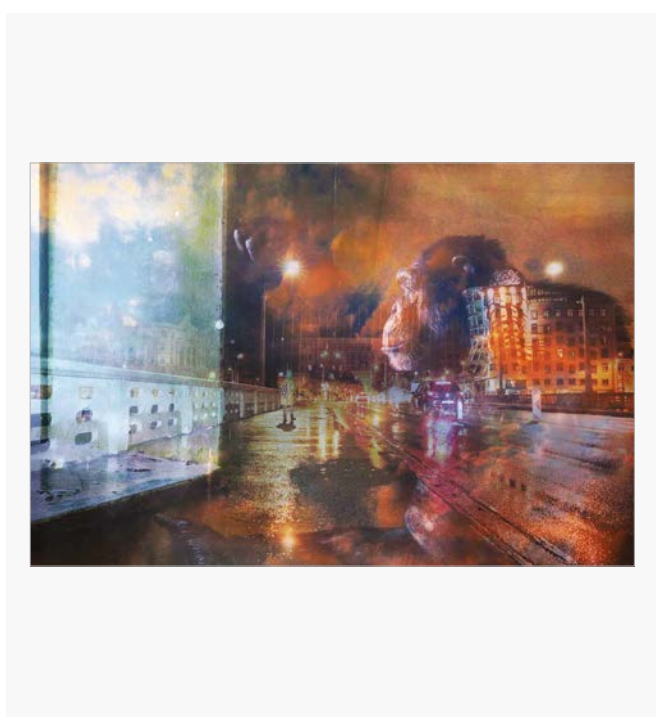

ID-011

Artist: Ivana Dostalova

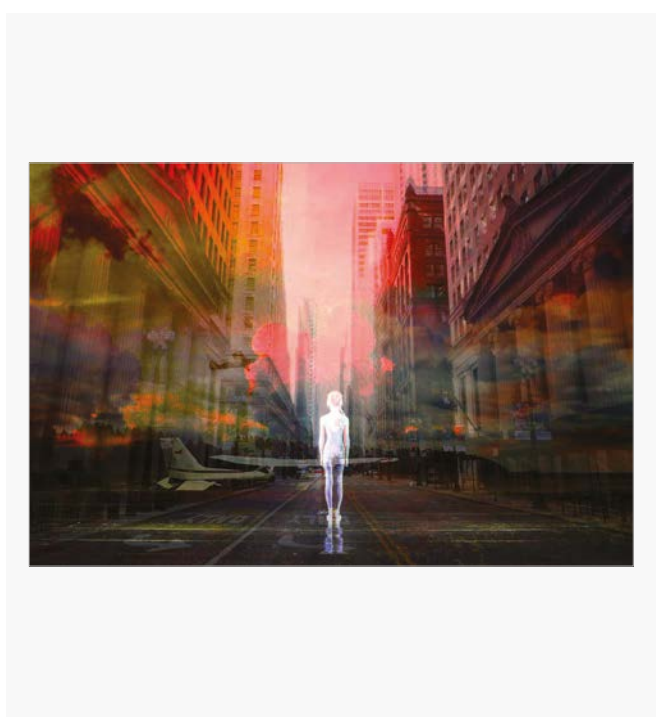

ID-012



Claudio Fabbri Ferrini

Artist: Claudio Fabbri Ferrini



CF-001

Artist: Claudio Fabbri Ferrini

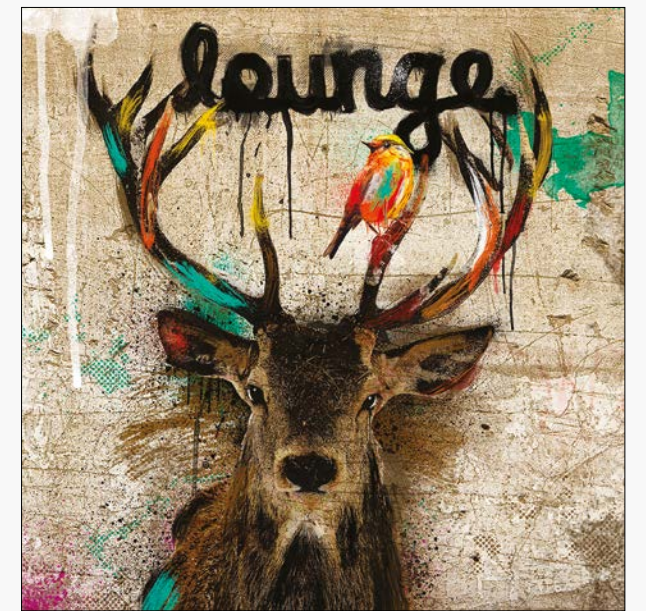

CF-002

Artist: Claudio Fabbri Ferrini



CF-003

Artist: Claudio Fabbri Ferrini



CF-004

"Non avrò mai abbastanza colore per dipingere i miei pensieri".

/ "I will never have enough colours to paint my thoughts".

Artist: Claudio Fabbri Ferrini

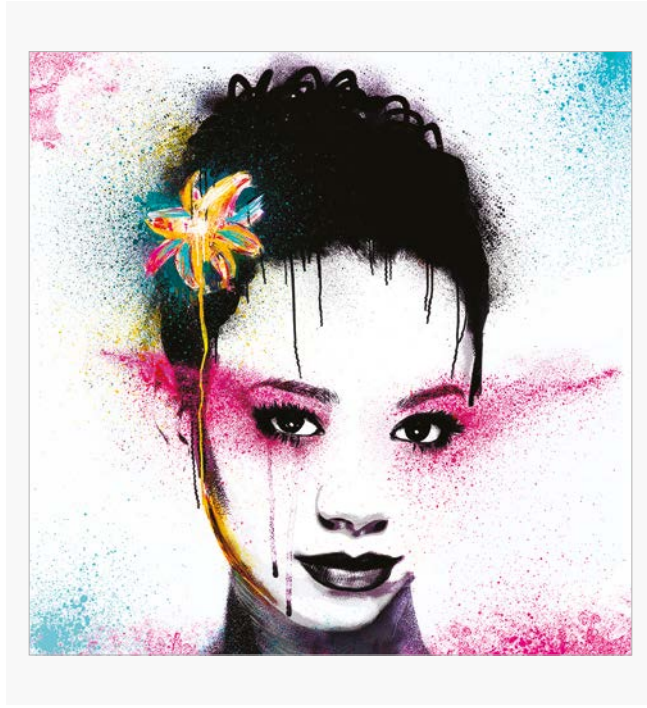

CF-005

Artist: Claudio Fabbri Ferrini



CF-007

Artist: Claudio Fabbri Ferrini



CF-006

Artist: Claudio Fabbri Ferrini



CF-008



Rie Froehlich

Artist: Rie Froehlich

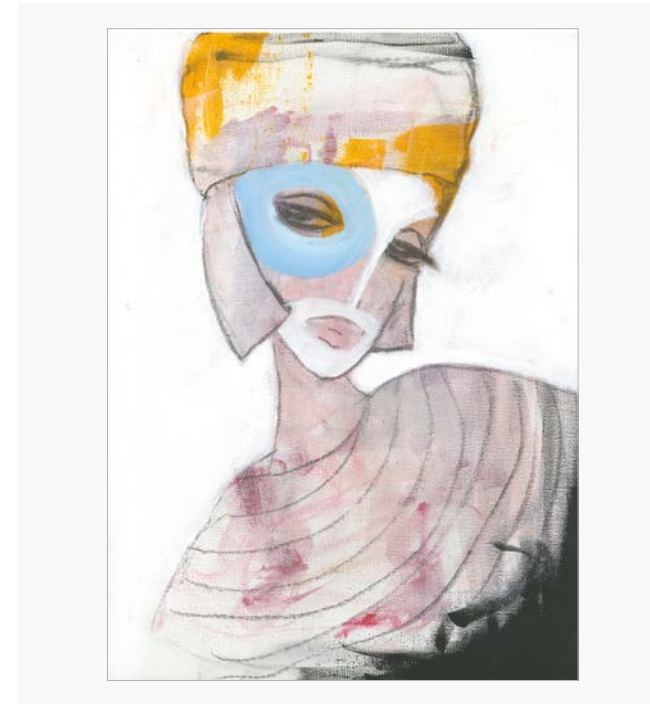

FR-001

Artist: Rie Froehlich

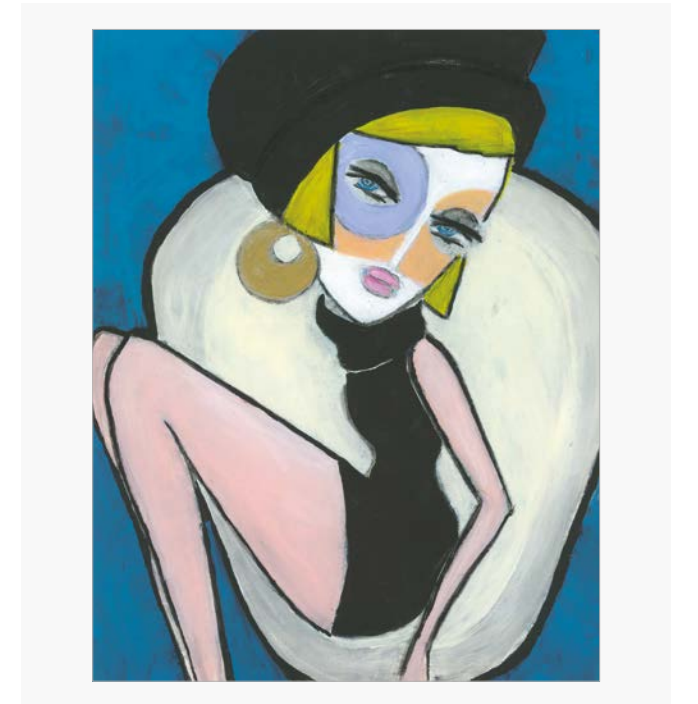

FR-002

Artist: Rie Froehlich

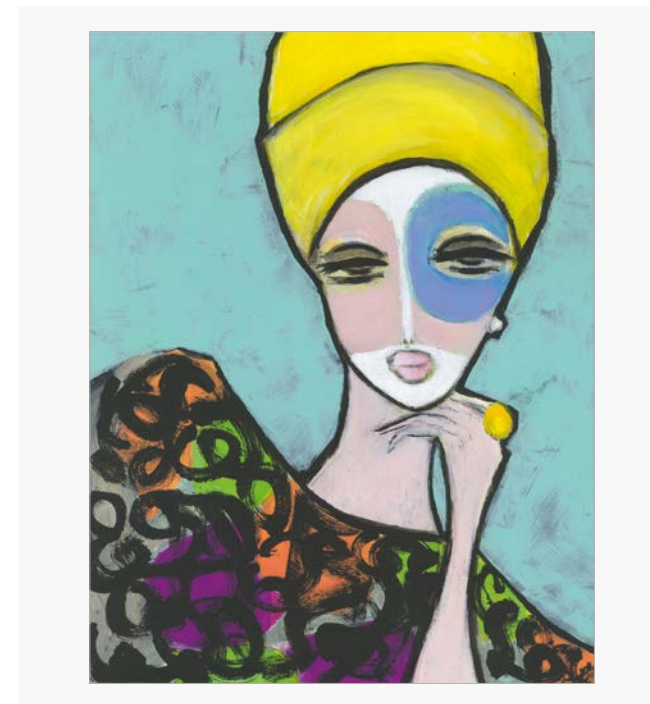

FR-003

Artist: Rie Froehlich



FR-004

Rie è un'artista autodidatta americana con creatività che esplode dal profondo. Incapsula drammatici tratti del viso, intense scene notturne e persino desideri sensuali umani esplorativi attraverso la sua pittura.

/ Rie is an American self-taught artist with creativity exploding from the core. She encapsulates dramatic facial features, intense night scenes, and even explorative human sexual desires through her painting.

Artist: Rie Froehlich



FR-005

Artist: Rie Froehlich



FR-006

Artist: Rie Froehlich



FR-009

Artist: Rie Froehlich



FR-011

Artist: Rie Froehlich



FR-007

Artist: Rie Froehlich



FR-008

Artist: Rie Froehlich



FR-012

Artist: Rie Froehlich



FR-013

Artist: Rie Froehlich

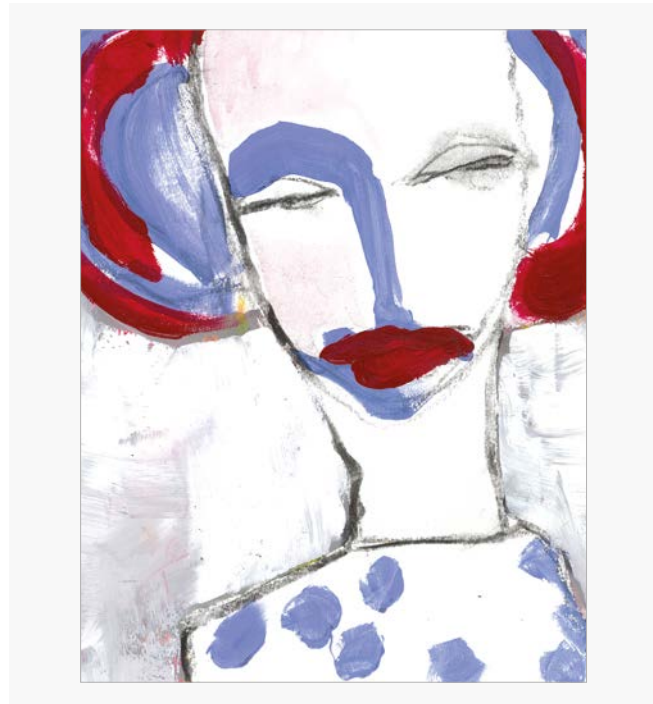

FR-014

Artist: Rie Froehlich



FR-015

Artist: Rie Froehlich

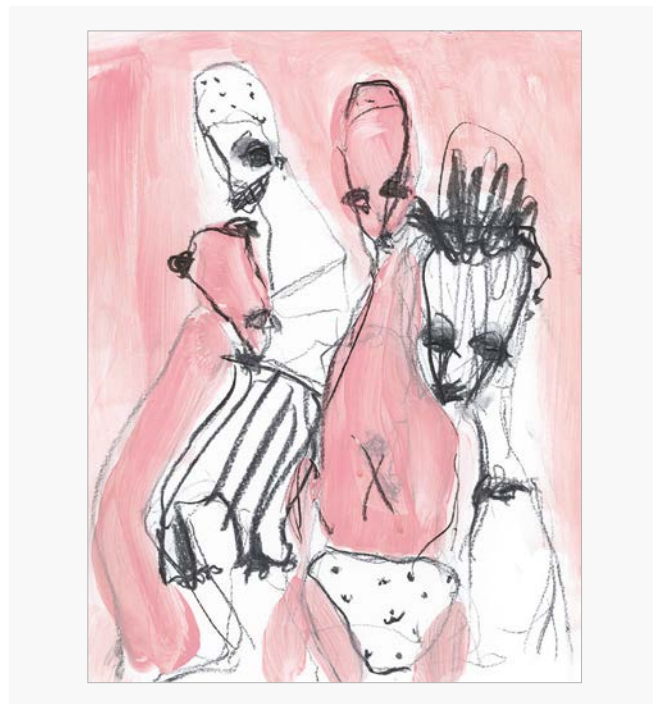

FR-017

Artist: Rie Froehlich

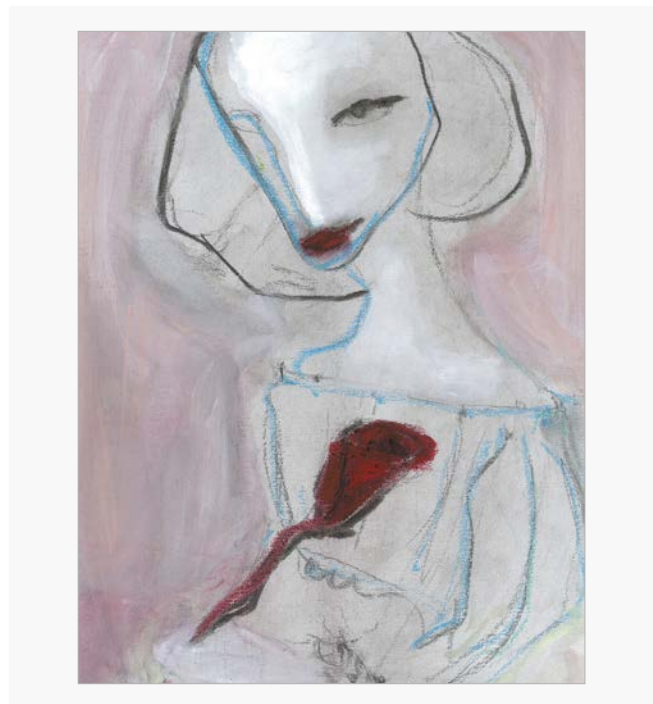

FR-018



Michela Gioachin

Michela Gioachin vive e lavora a Vicenza. Nel 2003 si laurea con lode all'Accademia di Belle Arti di Venezia, studiando Pittura con i maestri Riccardo Guarneri, Ennio Finzi, Luca Bendini e Maurizio Martelli e anatomia con il prof. Mauro Zocchetta con il quale successivamente ha collaborato. Durante gli studi accademici arriva la folgorazione che dà inizio alla sua attuale ricerca pittorica: "Tutto è nato da un errore. Durante gli studi in Accademia fotografavo gli altri studenti, li ritraevo cercando nei loro volti le espressioni più disparate. Cercavo il dettaglio e la precisione per una pittura successiva che fosse vicino all'iperrealismo. E poi è accaduto che uno scatto risultasse sbagliato...". Questo particolare "errore", chiamato glitch (termine usato per indicare un breve difetto del sistema in vari campi di applicazione dell'elettronica), smette di essere scarto e diventa uno sbaglio romantico, una forma di poesia attraverso il quale i soggetti sono "elettricamente divisi", "sdoppiati" per raccontare di sé il costante divenire.

/ Michela Gioachin lives and works in Vicenza. In 2003 he graduated with honors from the Academy of Fine Arts in Venice, studying painting with the masters Riccardo Guarneri, Ennio Finzi, Luca Bendini and Maurizio Martelli and anatomy with prof. Mauro Zocchetta with whom he subsequently collaborated. During his academic studies, he was struck by the shock that gave rise to his current pictorial research: "Everything was born from a mistake. During my studies at the Academy I photographed the other students, I portrayed them looking for the most disparate expressions in their faces. I was looking for detail and precision for a subsequent painting that was close to hyperrealism. And then it happened that a shot was wrong ...". This particular "error", called glitch (term used to indicate a brief defect of the system in various fields of application of electronics), stops being waste and becomes a romantic mistake, a form of poetry through which the subjects are "electrically divided", "split" to tell about the constant becoming.

Artist: Michela Gioachin

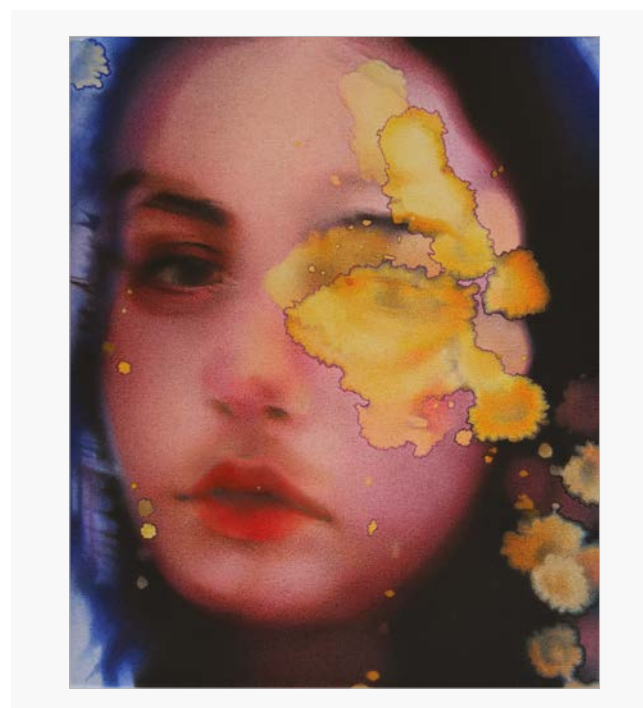

MI-001

Artist: Michela Gioachin



MI-002

Artist: Michela Gioachin

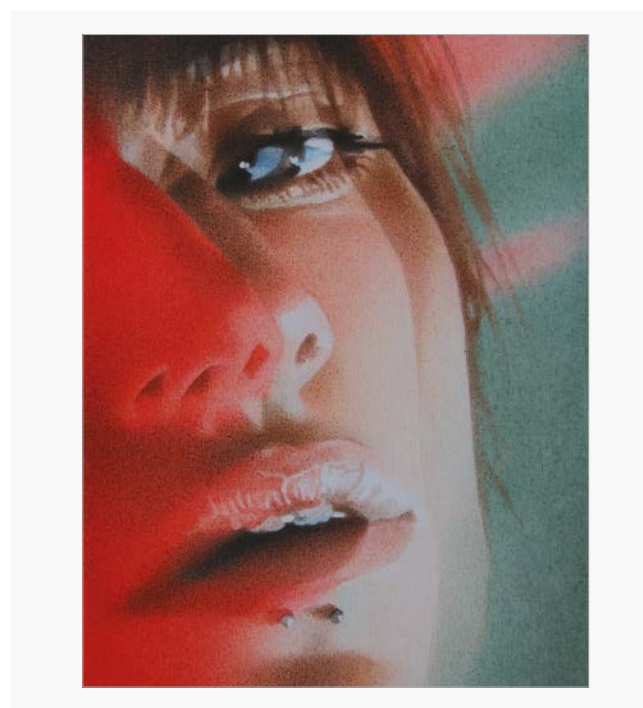

MI-003

Artist: Michela Gioachin



MI-004

Artist: Michela Gioachin

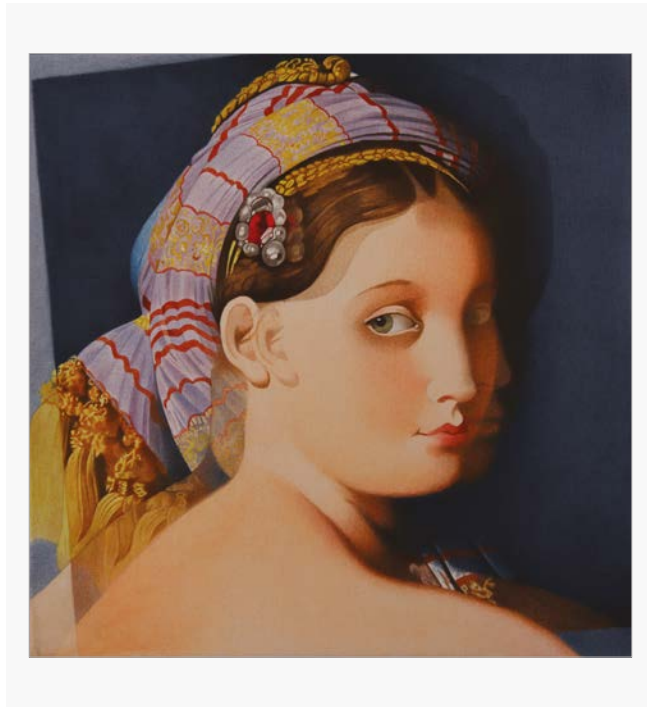

MI-005

Artist: Michela Gioachin



MI-006

Artist: Michela Gioachin



MI-007

Artist: Michela Gioachin

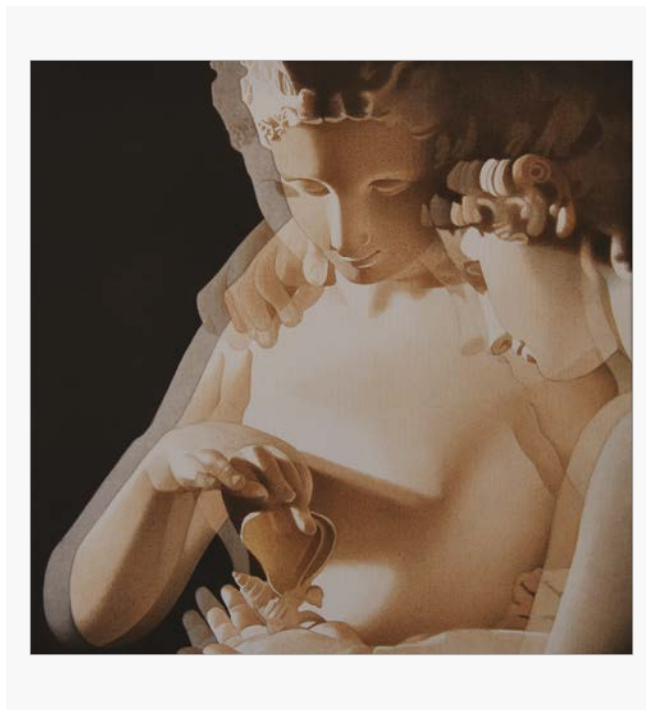

MI-008



Marco Grassi

Marco Grassi (Grama) è un pittore di origine italiana, nato a Milano nel 1966 e ora vive e lavora a Lugano, Svizzera. Nei suoi lavori predomina, su tutti gli altri soggetti, la bellezza eterea e sfuggente, delicata e perfetta di giovani donne. Fin dagli inizi della sua carriera, Marco Grassi ha sviluppato uno stile molto personale che elogia l'identità del soggetto femminile nel momento specifico in cui viene dipinto. Con i suoi intensi ritratti femminili, Marco cerca di affascinare lo spettatore, creando un dialogo silenzioso tra il soggetto e il pubblico. I pezzi di Marco Grassi sono sorprendenti, uniscono decorazione pura e colore iperrealistico. Nei suoi lavori più recenti, Marco ha abbandonato l'elemento che un tempo era il suo segno distintivo dello stile e della tecnica: le pennellate decise che delineavano le sue forme anatomiche e contrastavano con colori decisi, mescolati con un spatola e sgocciolato per sfaldarli e renderli più sottili. Meno certezze mostrano i suoi soggetti recenti. Oggi lo sfondo su cui sono rappresentati è più deciso e riflette le espressioni facciali dei soggetti e l'intenso silenzio, creando una complicità con l'osservatore. Le opere di Marco Grassi sono state esposte in numerose mostre personali e collettive e fiere internazionali come Art Basel, SCOPE Basel e Moscow Art Fair. È stato selezionato per essere presente all'inaugurazione del Padiglione Italia alla Biennale di Venezia nel 2011.

/ Marco Grassi (Grama) is a painter of Italian origin, born in 1966 in Milan and now living & working in Lugano, Switzerland. In his works, the ethereal and elusive, delicate and perfect beauty of young women predominates on all other subjects. Since the beginnings of his career, Marco Grassi developed a very personal style which praises the identity of the female subject in the specific moment in which they are painted. With his intense female portraits, Marco searches to captivate the viewer, by creating a silent dialogue between the subject and the audience. Marco Grassi's pieces are striking, they combine pure decoration and hyper-realistic colour. In his most recent works, Marco has abandoned the element that was once his trademark style and technique: the decisive brushstrokes which outlined his anatomic forms and contrasted with bold colours, blended with a spatula, and drippings to break them down and make them more subtle. His recent subjects display less certainty. Today, the background against which they are represented is more decisive and reflects the subjects' facial expressions and intense silence, creating a complicity with the observer. Marco Grassi's works have been exhibited in many solo and group exhibitions, and international fairs such as Art Basel, SCOPE Basel and the Moscow Art Fair. He was selected to be at the opening of the Italian Pavilion at the Venice Biennale in 2011.

Artist: Marco Grassi

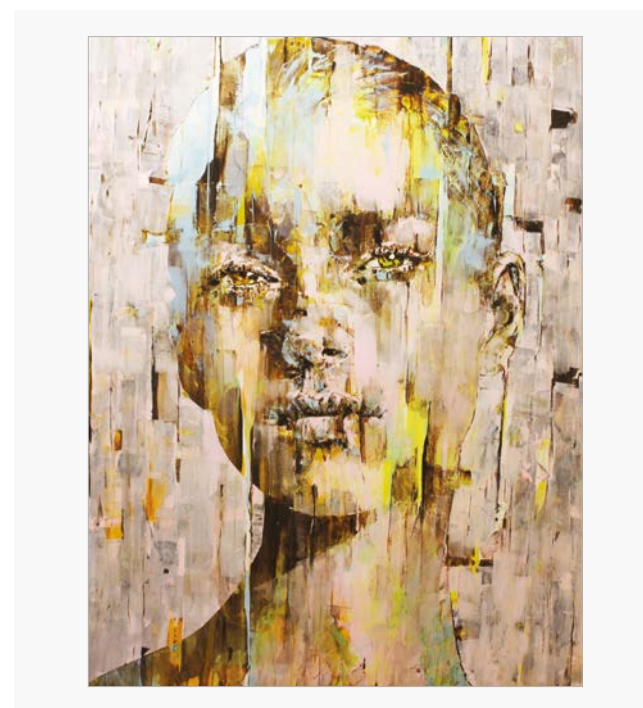

MG-001

Artist: Marco Grassi

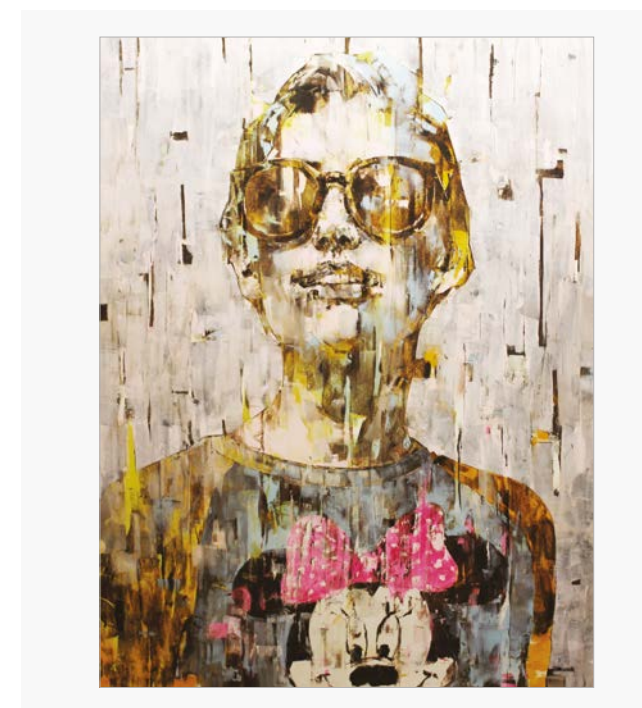

MG-003

Artist: Marco Grassi

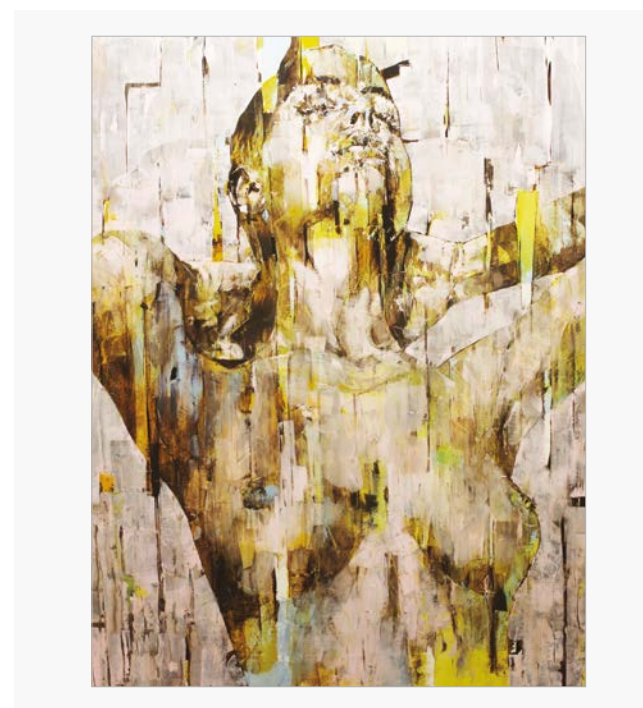

MG-004

Artist: Marco Grassi

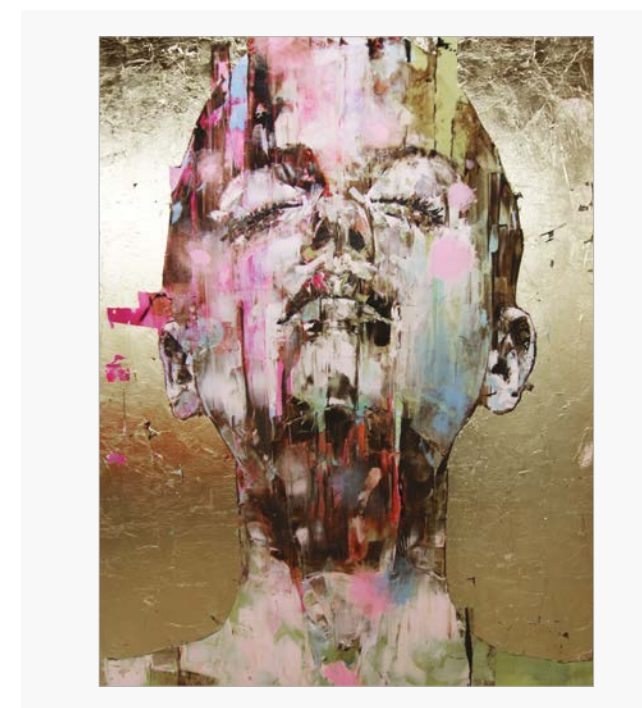

MG-005

Artist: Marco Grassi



MG-008

Artist: Marco Grassi

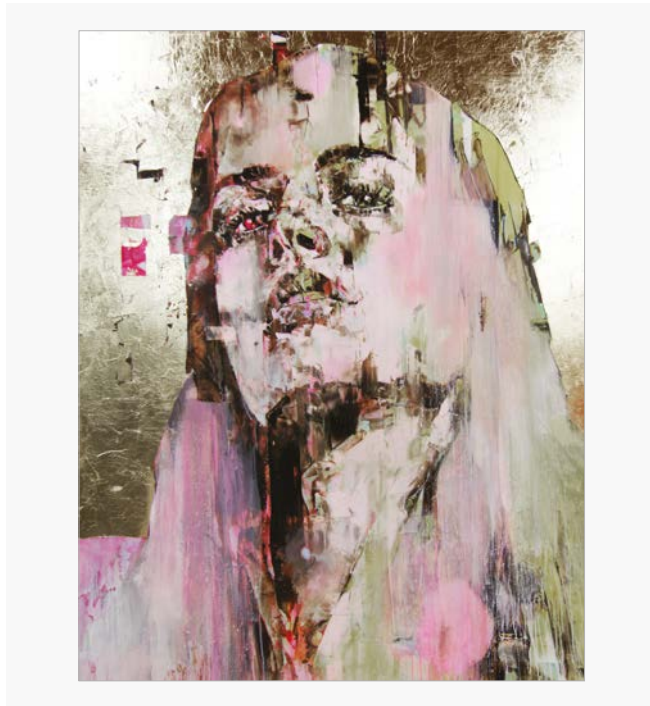

MG-009

Artist: Marco Grassi



MG-011

Artist: Marco Grassi



MG-012



Artist: Marco Grassi



MG-013

Artist: Marco Grassi

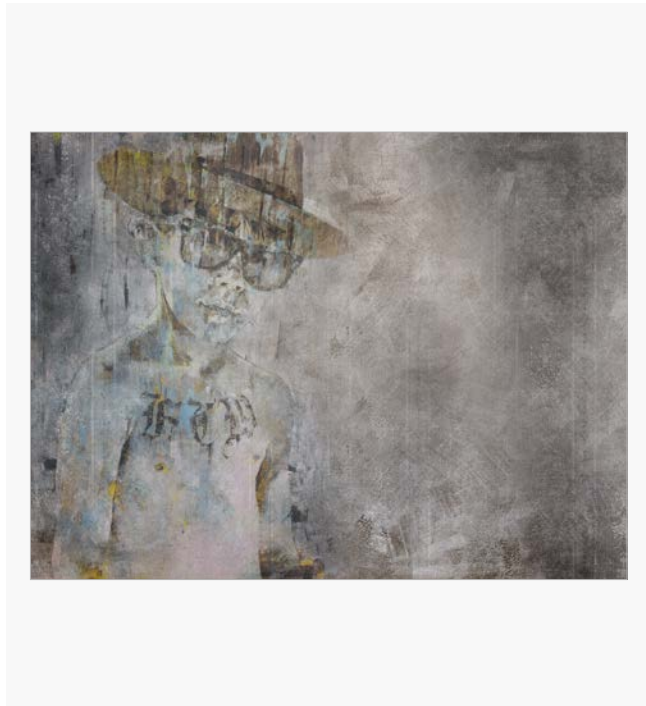

MG-015

Artist: Marco Grassi

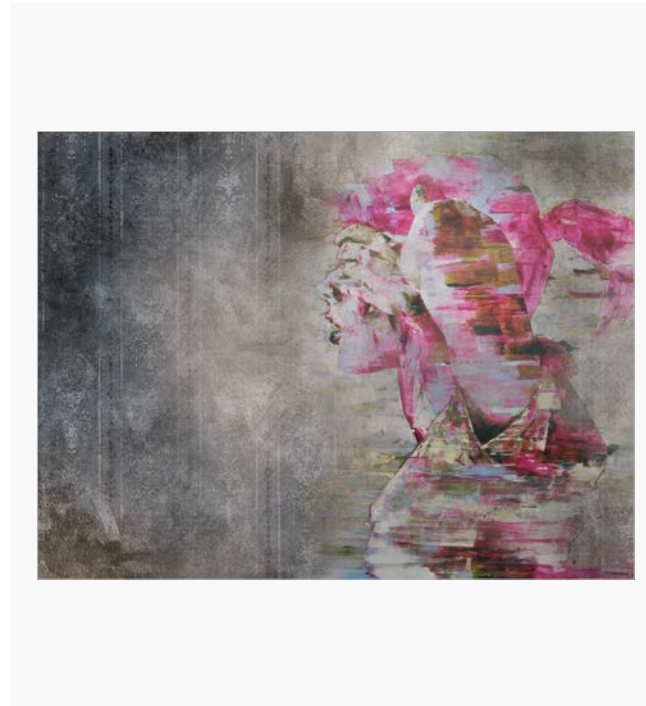

MG-019

Artist: Marco Grassi

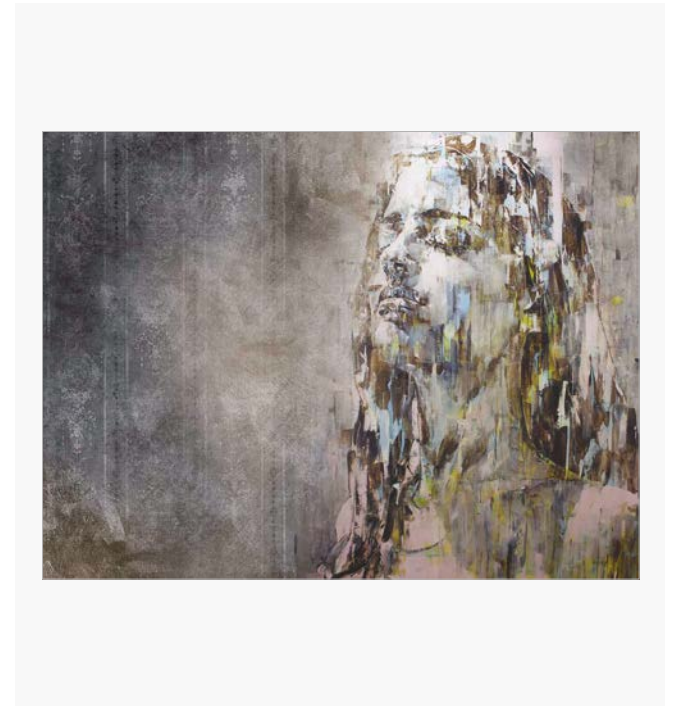

MG-020

Artist: Marco Grassi

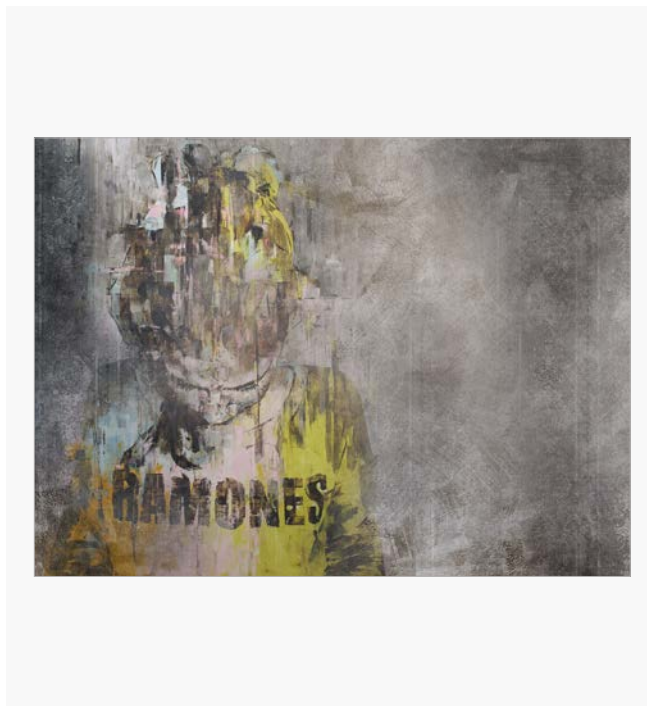

MG-017

Artist: Marco Grassi

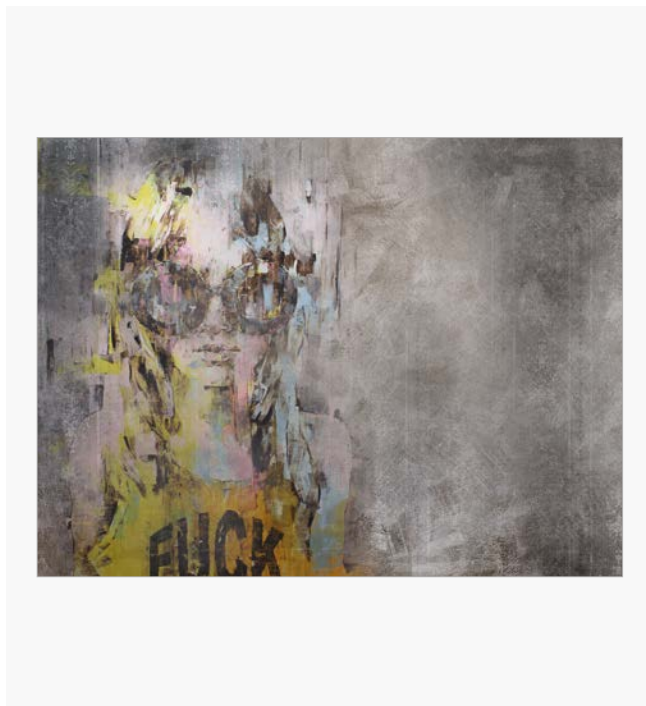

MG-018

Artist: Marco Grassi

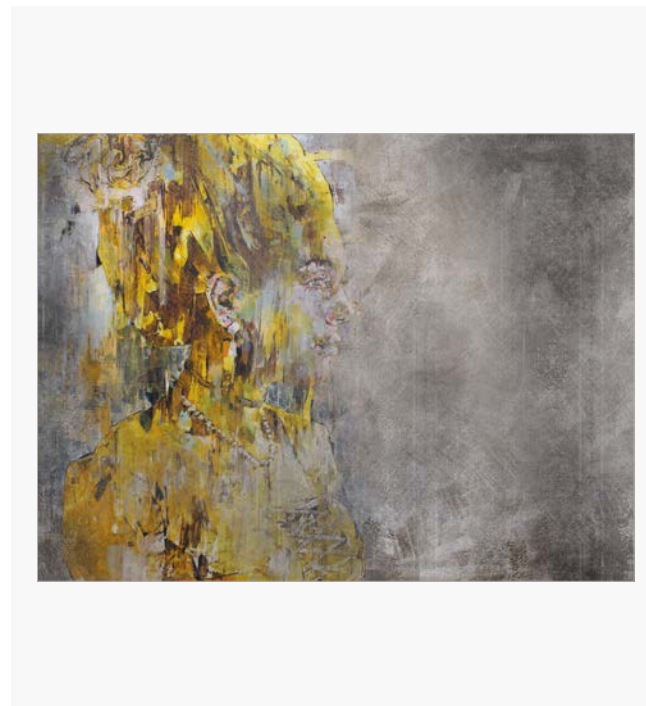

MG-021

Artist: Marco Grassi

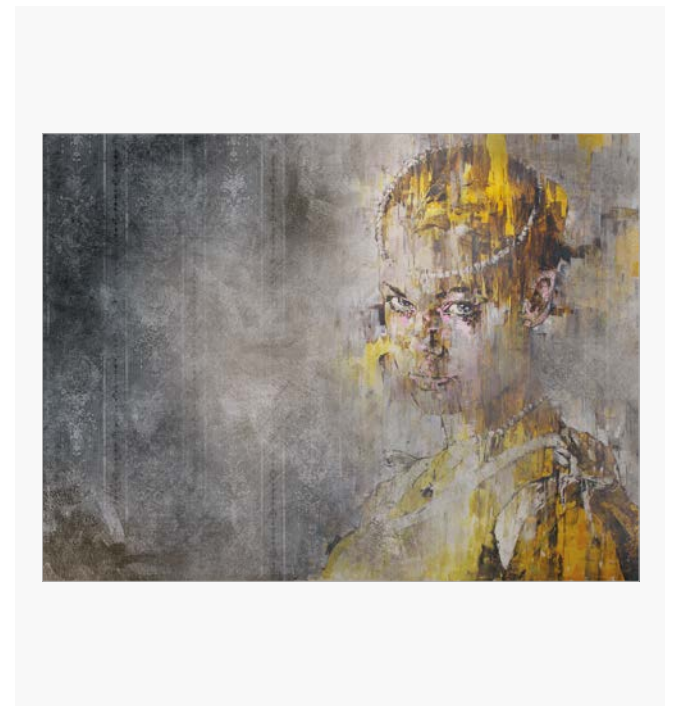

MG-022



Artist: Marco Grassi



MG-023

Artist: Marco Grassi



MG-024

Artist: Marco Grassi



MG-026

Artist: Marco Grassi



MG-027

Artist: Marco Grassi

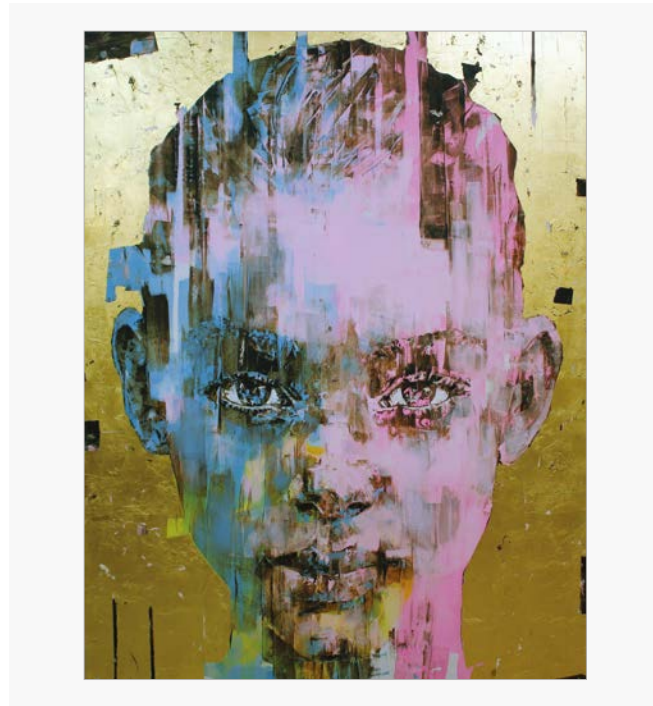

MG-029

Artist: Marco Grassi

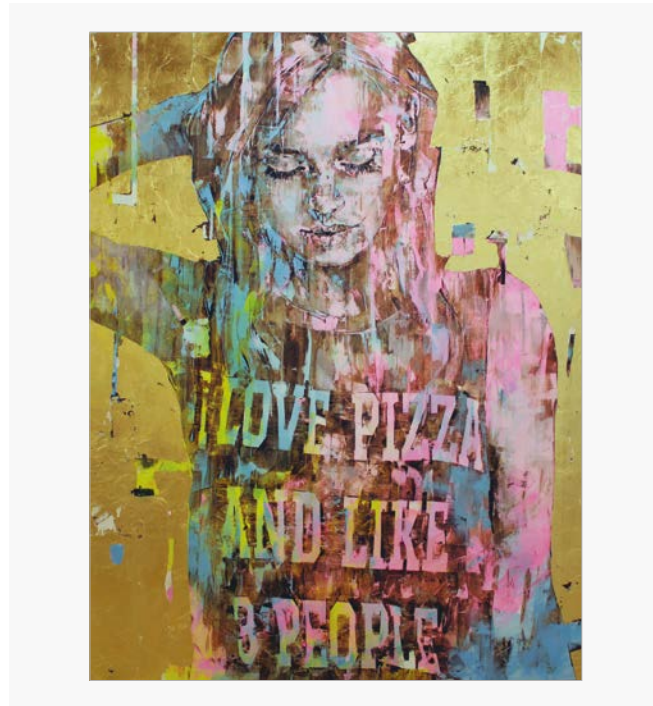

MG-030

Artist: Marco Grassi

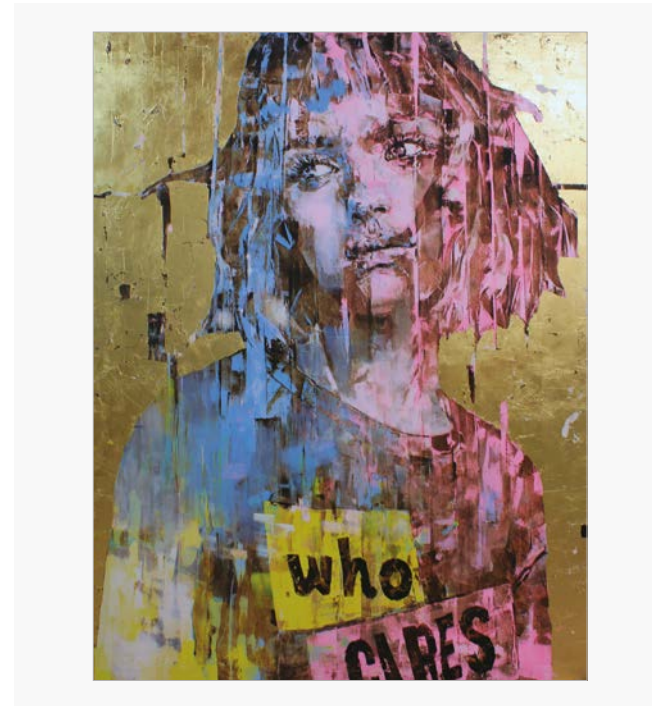

MG-035

Artist: Marco Grassi

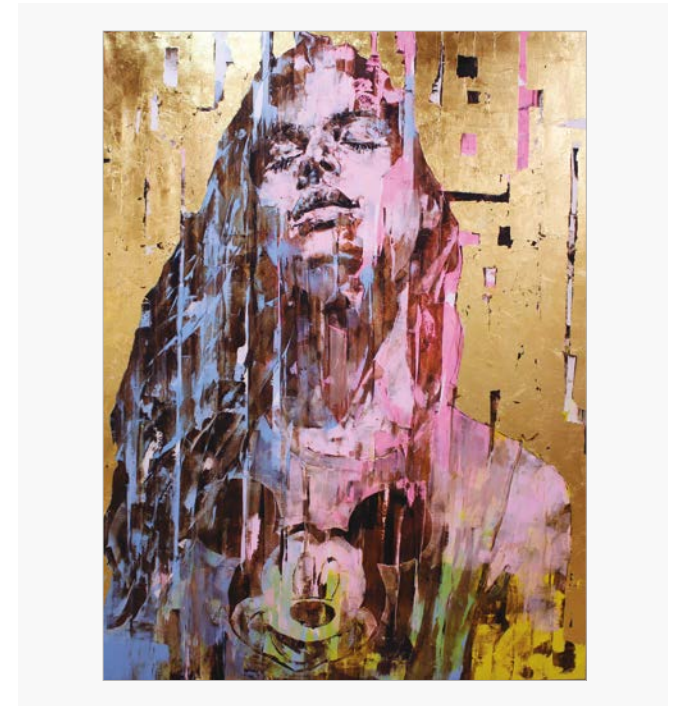

MG-036

Artist: Marco Grassi

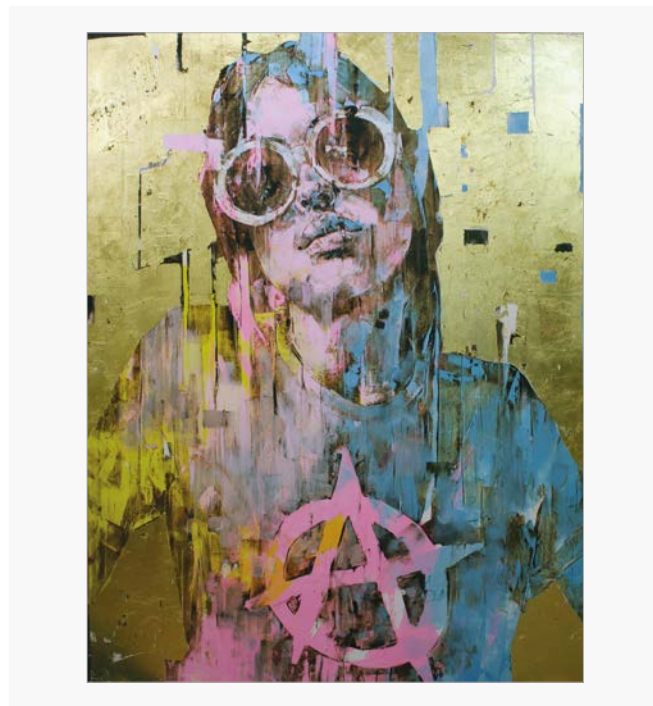

MG-031

Artist: Marco Grassi

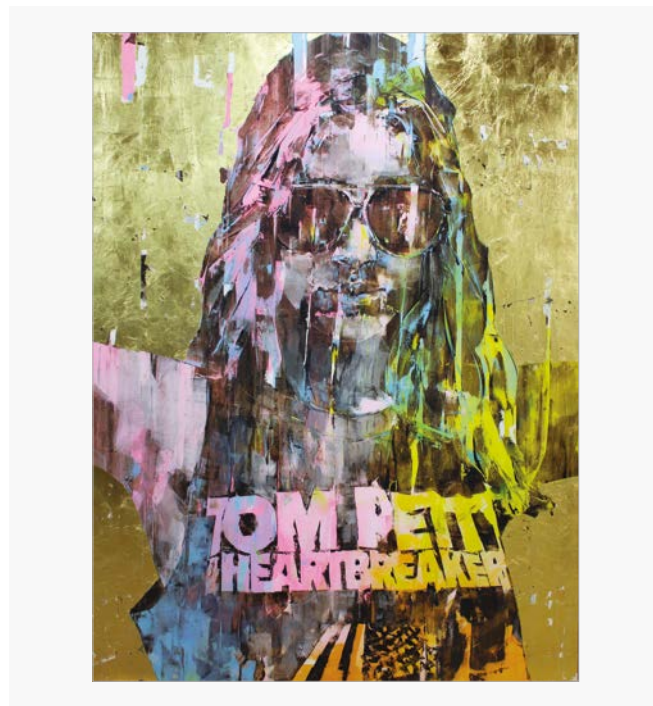

MG-034

Artist: Marco Grassi

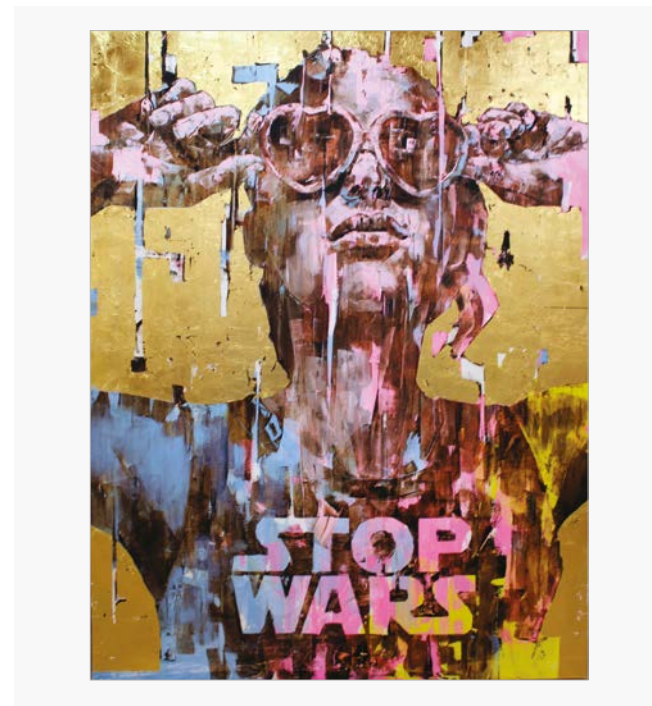

MG-037

Artist: Marco Grassi

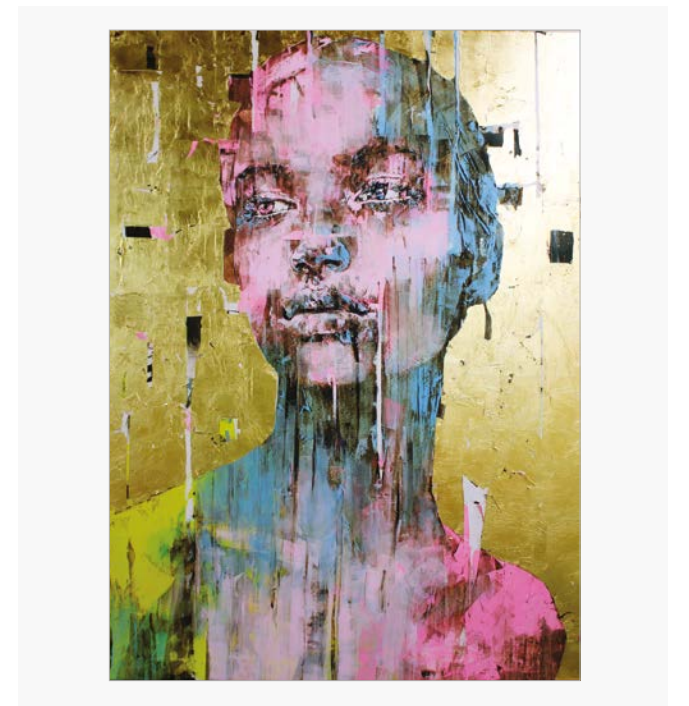

MG-038

Artist: Marco Grassi

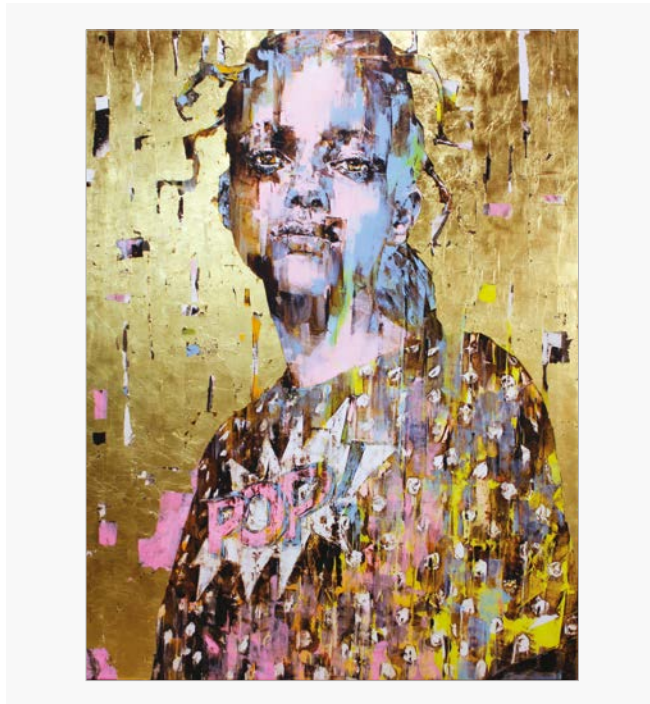

MG-040

Artist: Marco Grassi

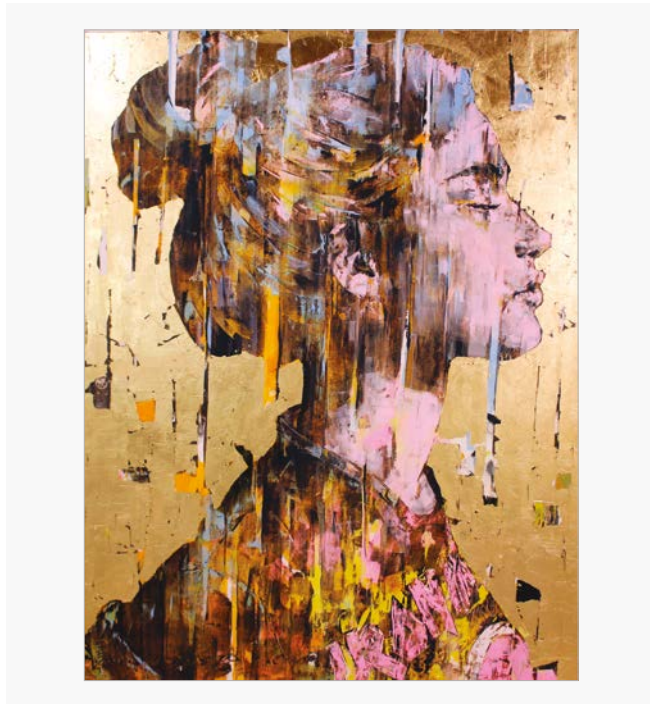

MG-043

Artist: Marco Grassi

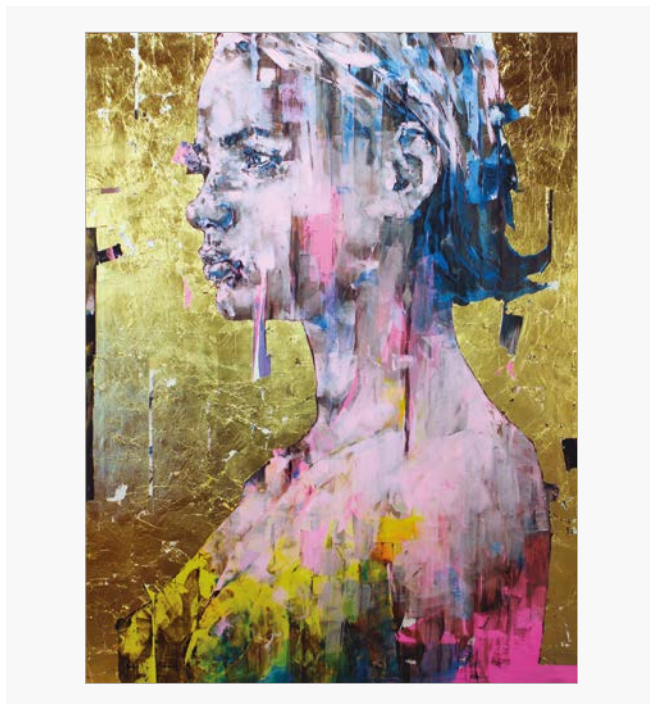

MG-046

Artist: Marco Grassi

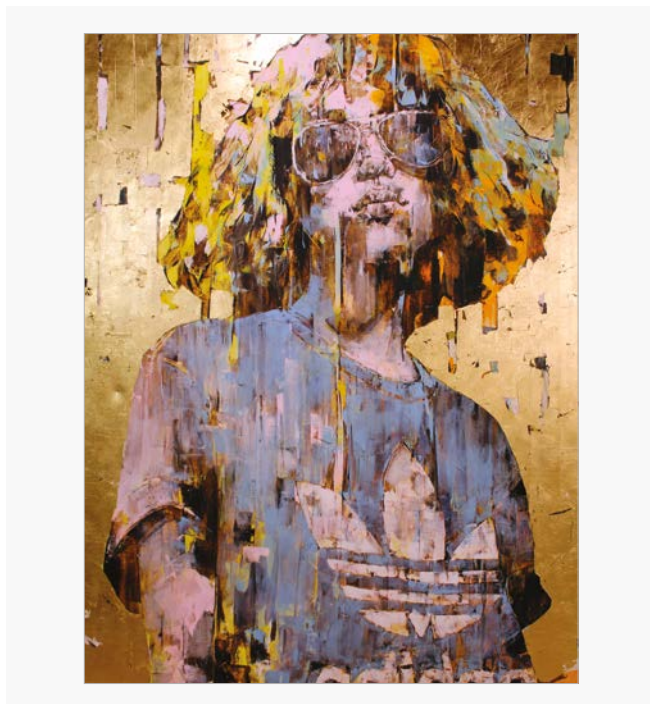

MG-047



Honet

Honet aveva 15 anni quando scoprì e si innamorò dei graffiti e ben presto divenne un punto di riferimento nella scena parigina prima di divenire riconosciuto a livello mondiale per il suo approccio eccentrico. È dopo qualche tempo che passa dalla bomboletta al pennello e passa dai muri della città alle gallerie. Il suo lavoro è profondamente ispirato dalla sua vita in costante movimento insieme alla sua romantica esplorazione del mondo - dall'Europa all'Asia. Il suo tratto inconfondibile così come le sue composizioni grafiche attira marchi di lusso tanto quanto la street fashion e le istituzioni globali.

/ Honet was 15 when he discovered and fell in love with graffiti and quickly became a reference in the Parisian scene before gaining worldwide recognition for his leftfield approach. It is later on that he add a brush on top of his can of spray-paint and moved from city walls to galleries. His work is deeply inspired by his life in constant movement together with his romantic exploration of the world - from Europe to Asia. His unmistakable sharp lines and graphic compositions appeal just as much to luxury brands, street fashion and global institutions.

Artist: Honet



HO-001

Artist: Honet

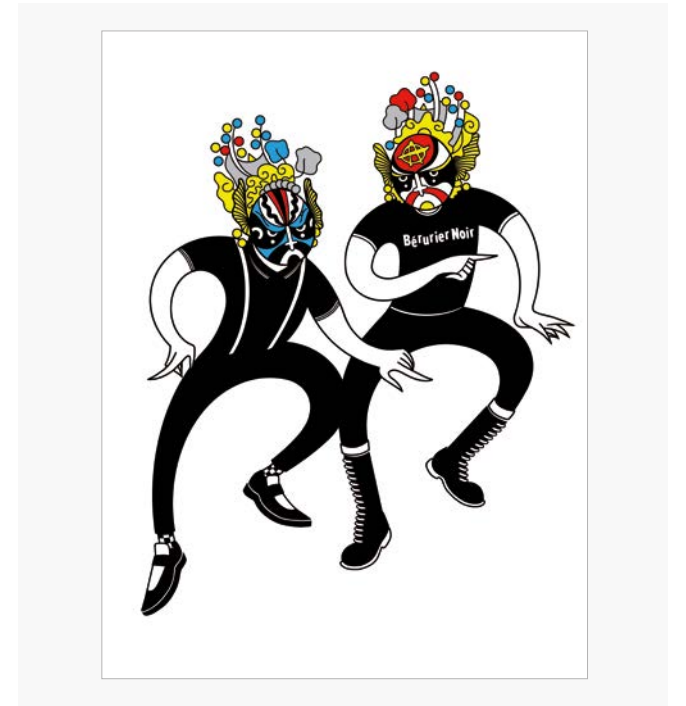

HO-002

Artist: Honet

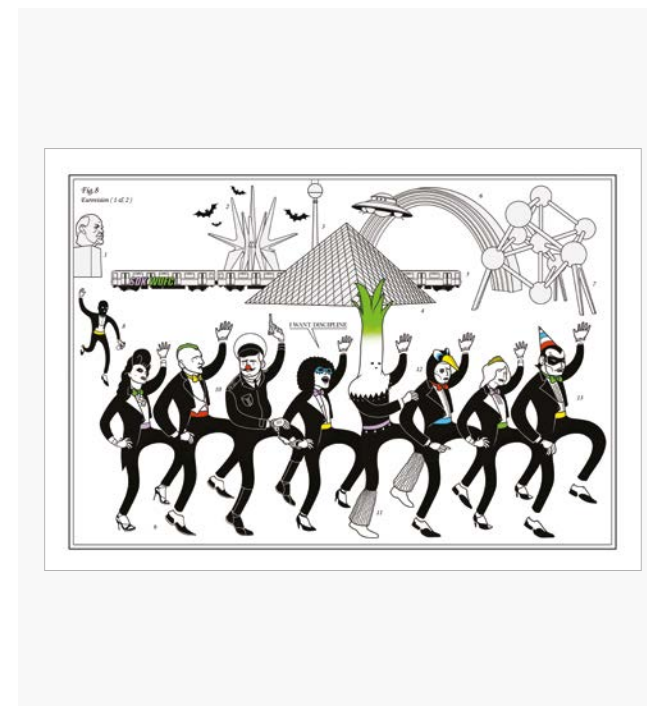

HO-003

Artist: Honet



HO-004

Artist: Honet



HO-005

Artist: Honet

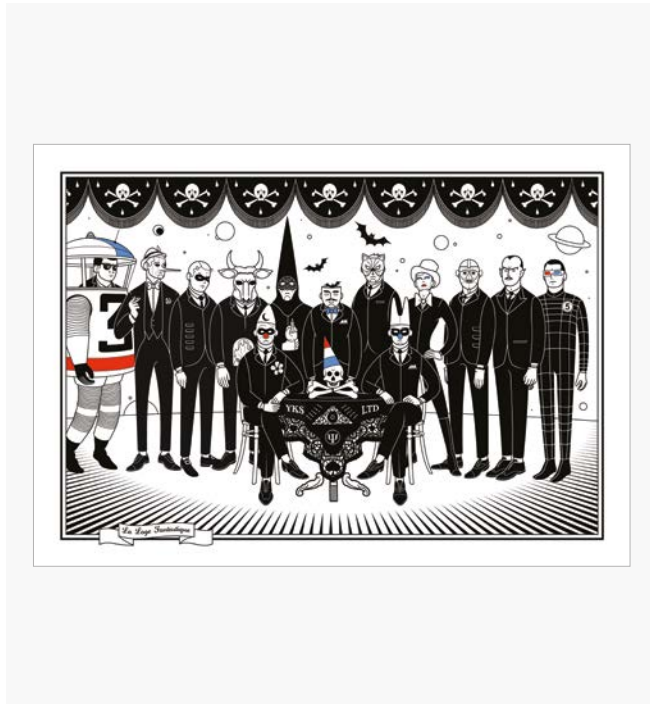

HO-006

Artist: Honet



HO-007

Artist: Honet



HO-008



Darren Hopes

Artist: Darren Hopes



DH-001

Artist: Darren Hopes



DH-002

Artist: Darren Hopes



DH-003

Artist: Darren Hopes

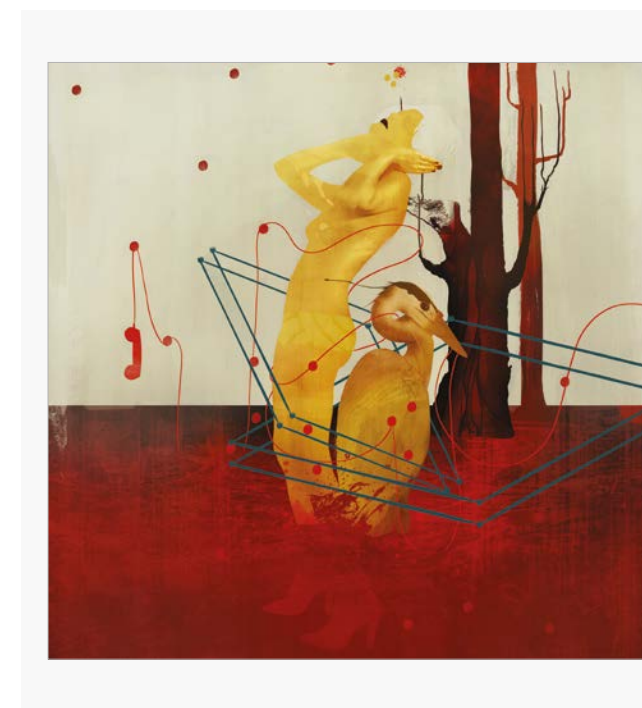

DH-004

Bloccato in un esilio autoimposto dal mondo esterno, Darren si nasconde nel suo attico in studio nell'ereмо nella profonda Cornovaglia creando esche visive in modo che i commissari del mondo possano essere tentati di contattarlo. Ha funzionato anche! Una laurea in fotografia e un amore per la pittura e le cose trovate guidano la sua illustrazione riccamente materica. Dopo aver conseguito un Bachelor's Degree in Design e Fotografia con Onorificenza, Darren ha lavorato con produzioni artistiche per gli ultimi 20 anni. È stato finalista per il premio Fotografo Erotico dell'Anno 2007.

/ Darren lurks in his attic studio hermitage in deepest Cornwall creating visual bait so that the commissioners of the world might be tempted into contacting him. It's worked too! A degree in Photography and a love of paint and found things lead his richly textural illustration. After earning a Bachelor's Degree in Design and Photography with honor, Darren has worked with artistic productions for the last 20 years. He was a finalist for the Erotic Photographer of the Year 2007 award.

Artist: Darren Hopes



DH-008

Artist: Darren Hopes

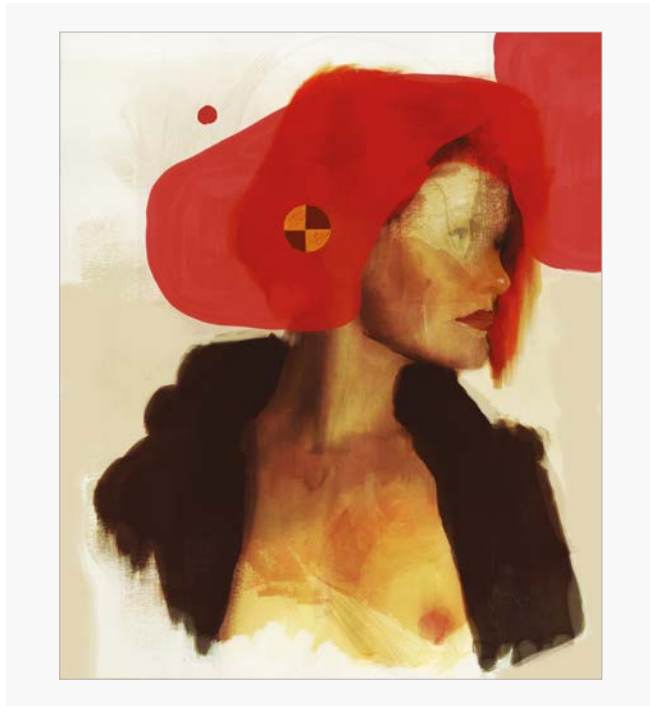

DH-010

Artist: Darren Hopes



DH-012

Artist: Darren Hopes



DH-014



Michelino Iorizzo

Artist: Michelino Iorizzo



MC-001

Artist: Michelino Iorizzo

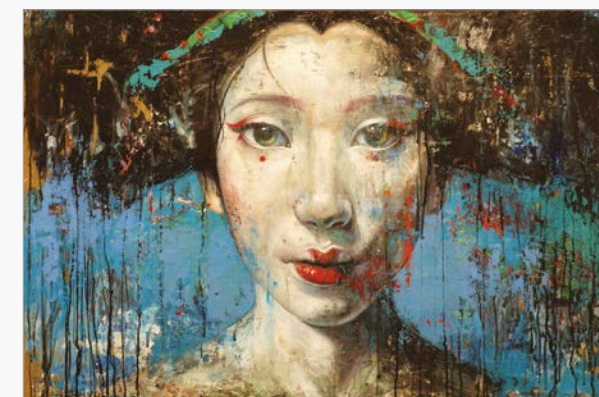

MC-002

Artist: Michelino Iorizzo



MC-003

Artist: Michelino Iorizzo



MC-004

"Il mio fare arte è una necessità. L'immaginazione mi nutre tutti i giorni, ed io non posso fare altro che renderla reale..."

I volti che vedo lungo il mio cammino vengono reinterpretati dalla mia pittura e a volte riaffiorano volti di persone conosciute molto tempo prima, ma quasi sempre sono volti che non esistono.

La mia tecnica affonda le radici nel passato. Precisamente è Tempera grassa e olio su tavola. Amo anche dipingere su carta e poi incollarla su tavola per continuare a lavorarci fino a che non diventa "Opera". In sintesi la mia cifra stilistica verte sul catturare quell'attimo che, paragonato alla durata della nostra vita, lo si può quantificare in un unico battito di ciglia ed io cerco di renderlo eterno..."

/ "My making art is a necessity. Imagination feeds me every day, and I can't help but make it real..."

The faces that I see along my path are reinterpreted by my painting and sometimes the faces of people I met a long time ago reappear, but they are almost always faces that do not exist. My technique has its roots in the past. Precisely it is Tempera grassa and oil on wood. I also love to paint on paper and then glue it to a table to continue working on it until it becomes "Opera". In summary, the stylistic figure focuses on my capturing that moment which, compared to the duration of our life, can be quantified in a single blink of an eye and I try to become eternal..."

Artist: Michelino Iorizzo

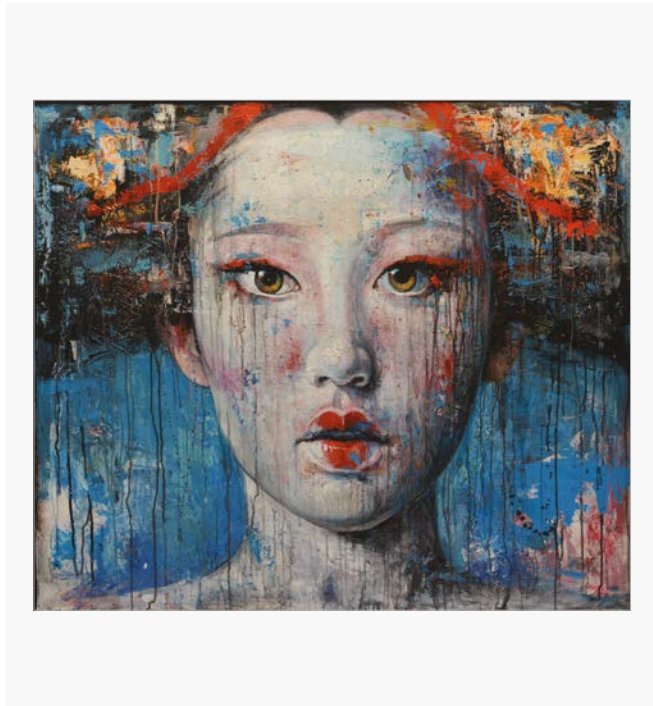

MC-005

Artist: Michelino Iorizzo



MC-006

Artist: Michelino Iorizzo



MC-009

Artist: Michelino Iorizzo



MC-010

Artist: Michelino Iorizzo



MC-007

Artist: Michelino Iorizzo



MC-008

Artist: Michelino Iorizzo

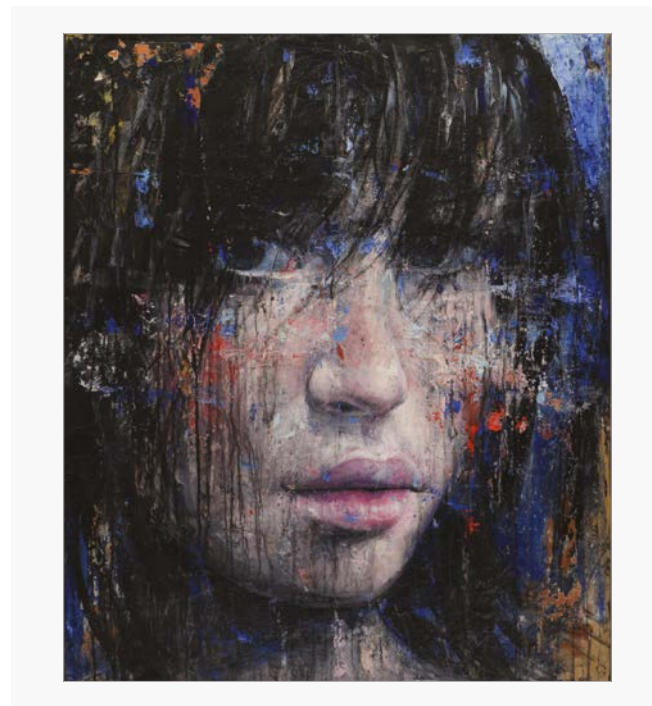

MC-011

Artist: Michelino Iorizzo



MC-012

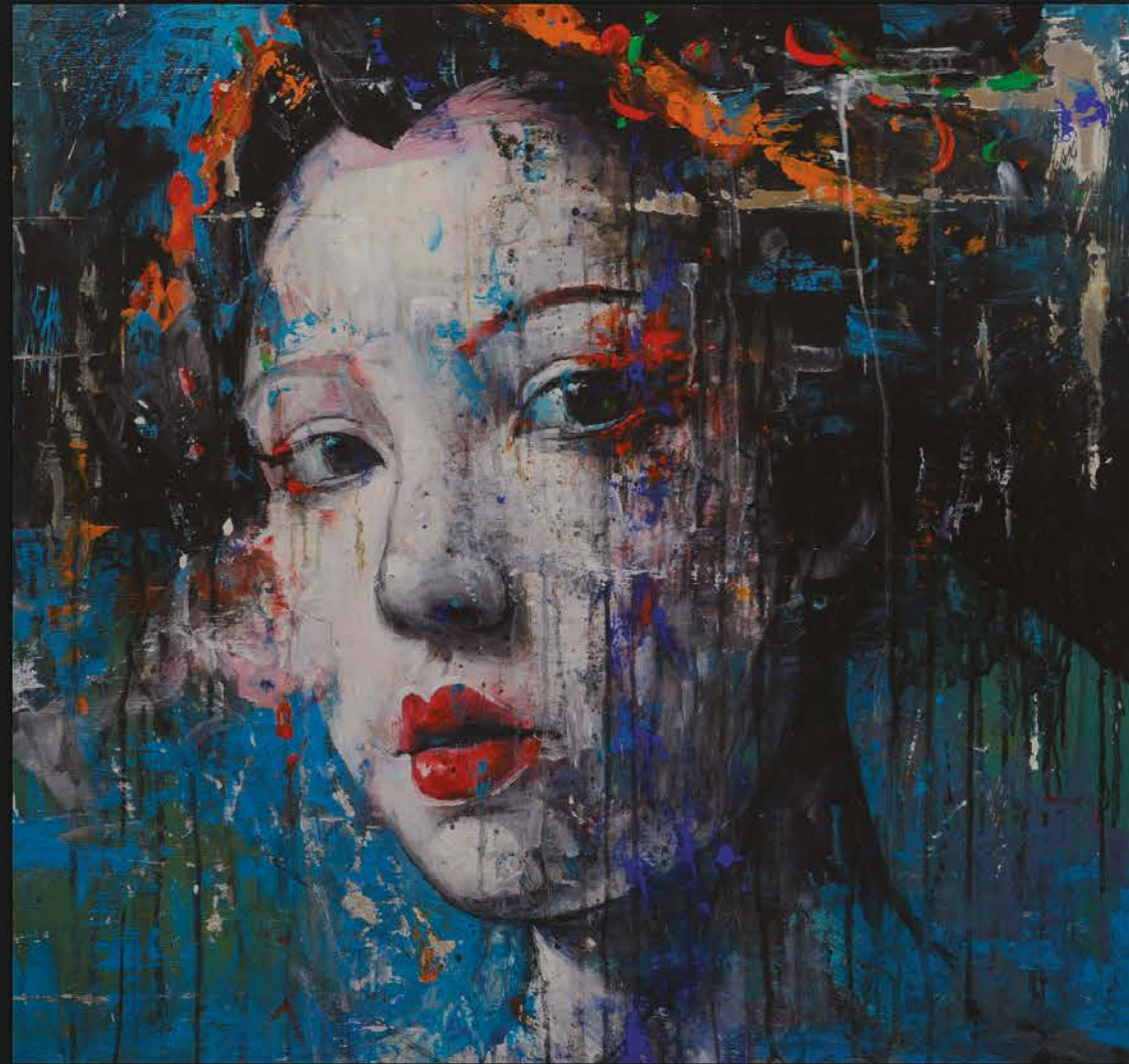

Giulio Iurissevich

Giulio Iurissevich ha intrapreso la carriera di fotografo e grafico nel 1998. Specializzato in fashion, lifestyle e beauty, è anche artista urbano. Giulio si concentra sulla figura umana e soprattutto sulle lievi sfumature di espressione in ritratti di volti femminili. Spinto dall'istinto e ispirato dalla forma umana, il lavoro di Giulio esplora il volume, la geometria e il colore, riducendo gli effetti non necessari e concentrandosi invece su linee e forme pulite. Il suo lavoro è astratto, con una forte influenza sulla cultura di strada urbana. Unico e versatile, il fascino di Giulio si estende ben oltre la sua natia Italia, e in particolare nel Regno Unito, negli Stati Uniti, in Canada e in Germania, dove i suoi clienti includono Karim Rashid, Motorola, Virgin, Oxford University Press, Music for Relief, New York City Marathon, Start Mobile, Image Zoo, Shelter, Frezza Inc-Casamania, Thedesignconspiracy UK, Qub Studios e le riviste Elle, Marie Claire, The Source, Vogue, Runner's World, Vision Magazine (Cina) e Rivista Ottagono (Italia). Il suo successo si riflette anche nella sua inclusione in diversi importanti libri di illustrazione di moda, tra cui The Big Book of Fashion di Martin Dawber e pubblicato da Bt Batsford (Regno Unito), Text and Image vol 2 pubblicato da AVA-appliate visual arts (Svizzera), Enciclopedia dell'arte moderna e contemporanea (Alba Editrice) (Italia), Communication Arts the Annual (UK), Luerzer's Archive Best 200 Illustrators Worldwide (AU), Talentos de la ilustracion de moda (Spain).

/ Giulio Iurissevich began his career as a photographer and graphic designer in 1998. Specialized in fashion, lifestyle and beauty, he is also an urban artist. Giulio focuses on the human figure and above all on the slight nuances of expression in portraits of female faces. Driven by instinct and inspired by the human form, Giulio's work explores volume, geometry and color, reducing unnecessary effects and focusing instead on clean lines and shapes. His work is abstract, with a strong influence on urban street culture. Unique and versatile, Giulio's appeal extends far beyond his native Italy, and particularly to the UK, the United States, Canada and Germany, where his clients include Karim Rashid, Motorola, Virgin, Oxford University Press, Music for Relief, New York City Marathon, Start Mobile, Image Zoo, Shelter, Frezza Inc-Casamania, Thedesignconspiracy UK, Qub Studios and the magazines Elle, Marie Claire, The Source, Vogue, Runner's World, Vision Magazine (China) and Rivista Ottagono (Italy). Its success is also reflected in its inclusion in several major fashion illustration books, including Martin Dawber's The Big Book of Fashion and published by Bt Batsford (UK), Text and Image vol 2 published by AVA-applied visual arts (Switzerland), Encyclopedia of Modern and Contemporary Art (Alba Editrice) (Italy), Communication Arts the Annual (UK), Luerzer's Archive Best 200 Illustrators Worldwide (AU), Talentos de la ilustracion de moda (Spain).

Artist: Giulio Iurissevich



GI-001

Artist: Giulio Iurissevich

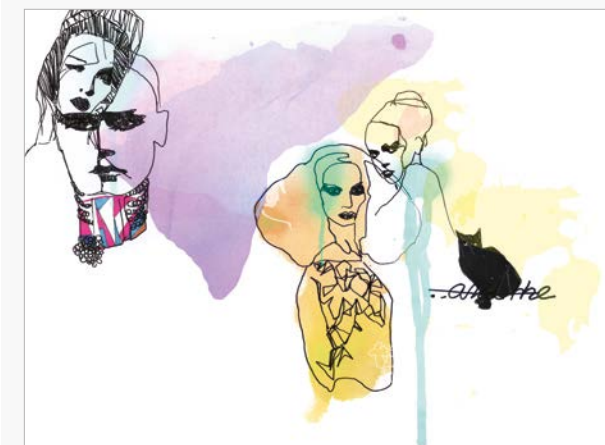

GI-002

Artist: Giulio Iurissevich



GI-003

Artist: Giulio Iurissevich

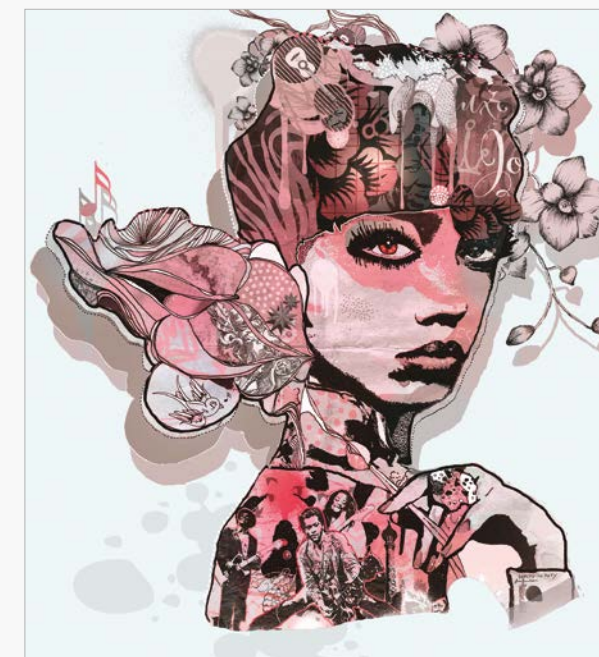

GI-004

Artist: Giulio Lurissevich

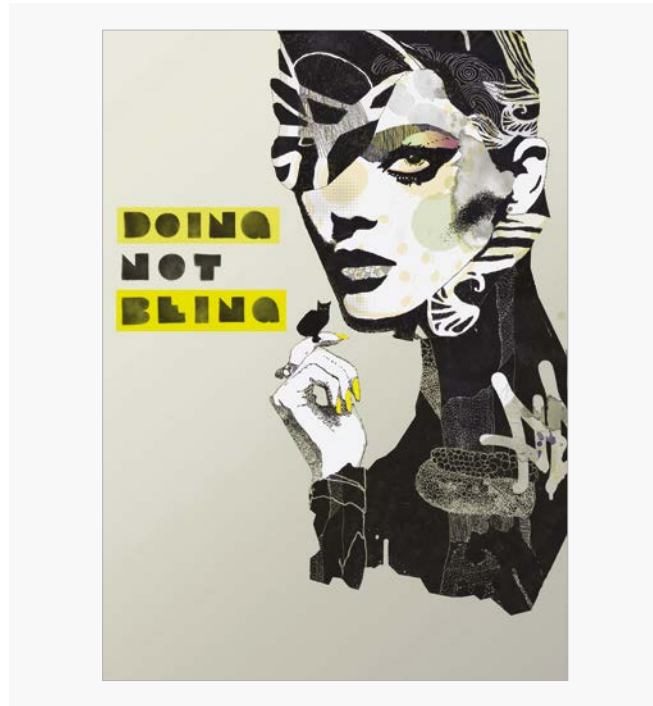

GI-005

Artist: Giulio Lurissevich

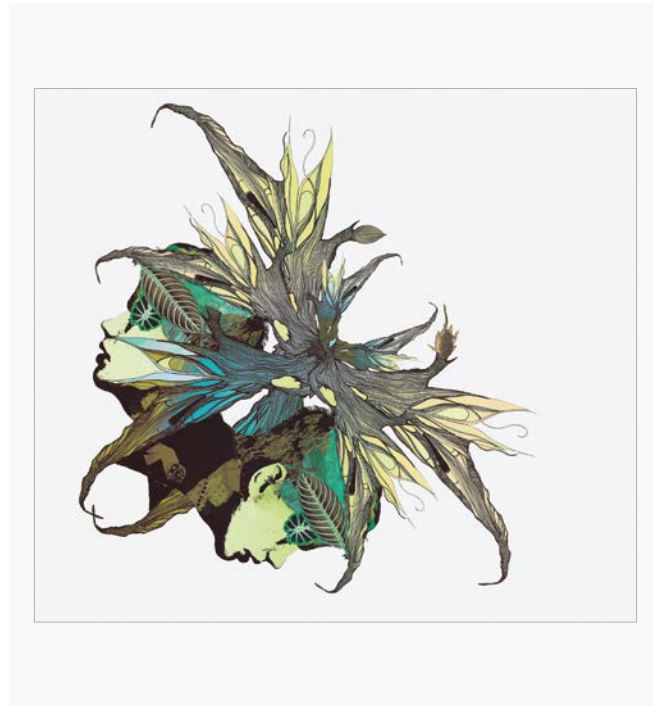

GI-007

Artist: Giulio Lurissevich

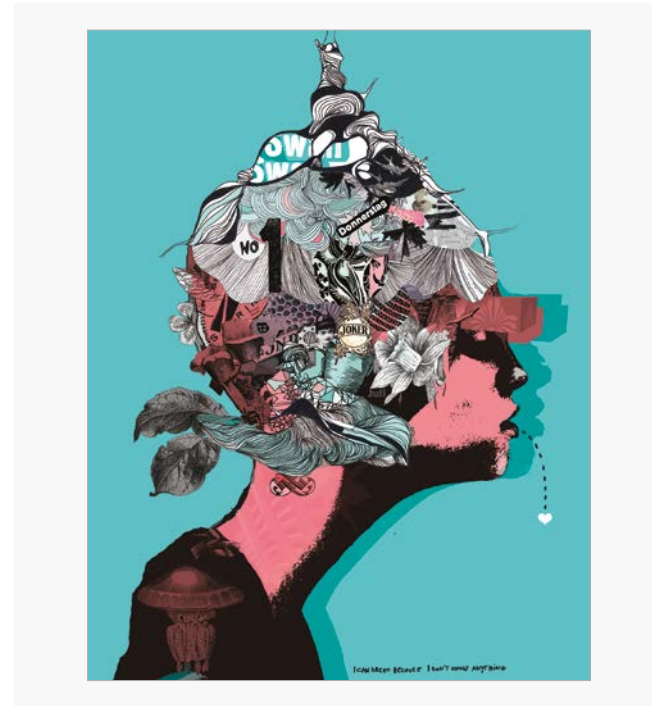

GI-012

Artist: Giulio Lurissevich

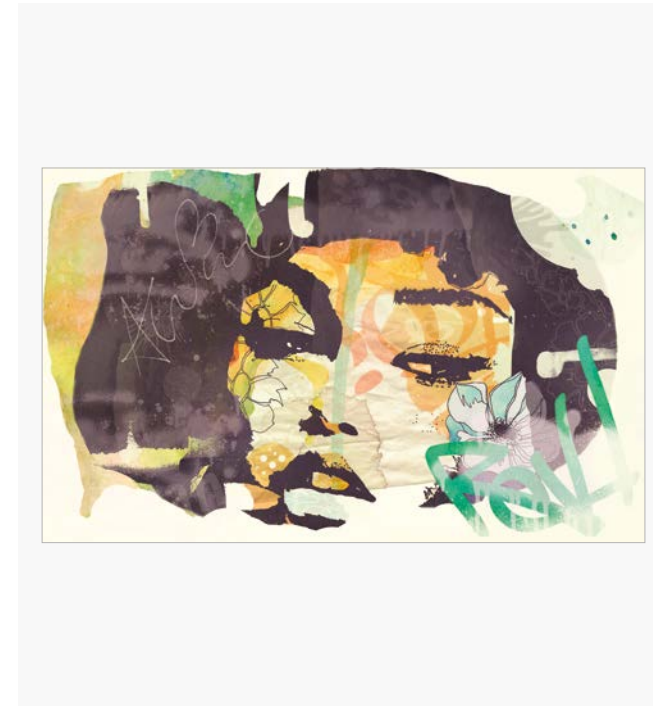

GI-013

Artist: Giulio Lurissevich

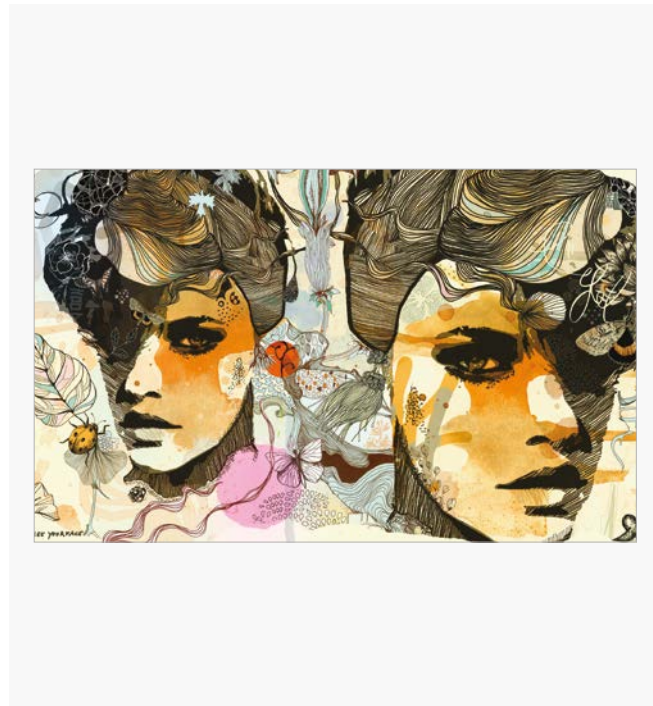

GI-009

Artist: Giulio Lurissevich

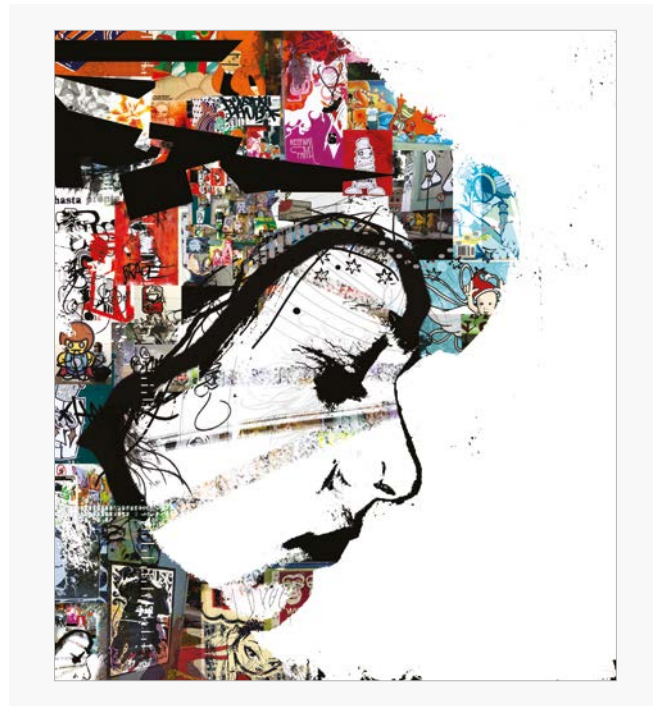

GI-010

Artist: Giulio Lurissevich



GI-014

Artist: Giulio Lurissevich

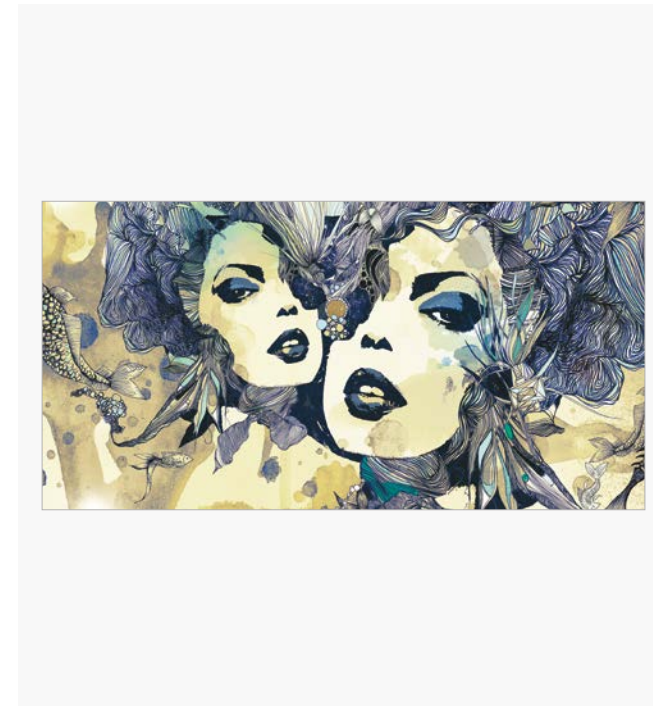

GI-015

Artist: Giulio Lurissevich



GI-016

Artist: Giulio Lurissevich

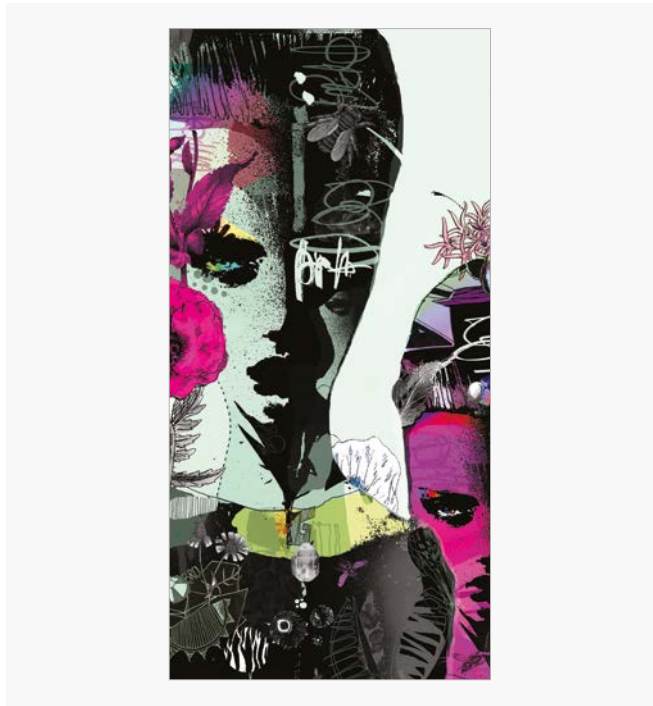

GI-018

Artist: Giulio Lurissevich



GI-023

Artist: Giulio Lurissevich



GI-026

Artist: Giulio Lurissevich

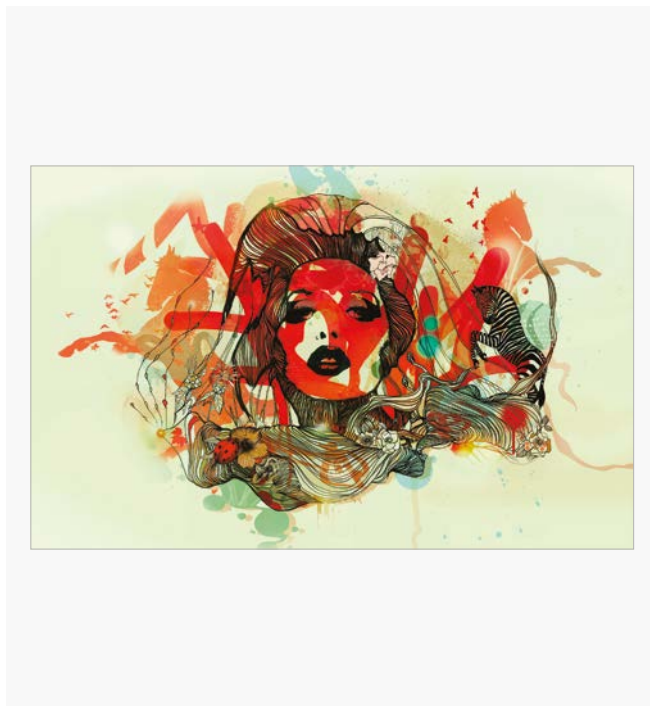

GI-021

Artist: Giulio Lurissevich

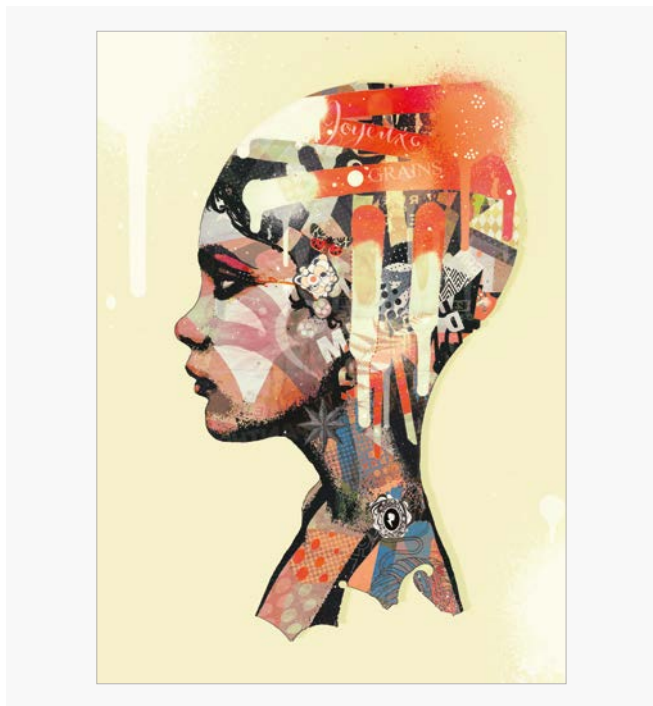

GI-022

Artist: Giulio Lurissevich

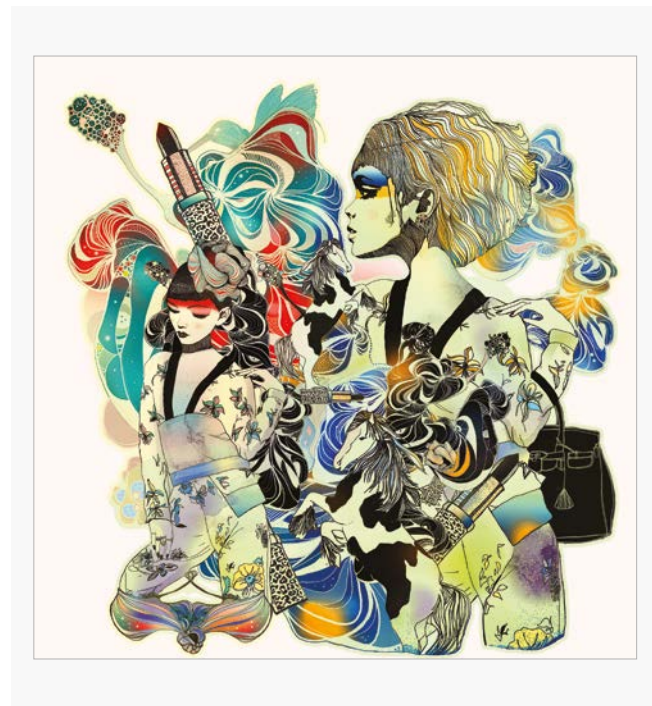

GI-027

Artist: Giulio Lurissevich

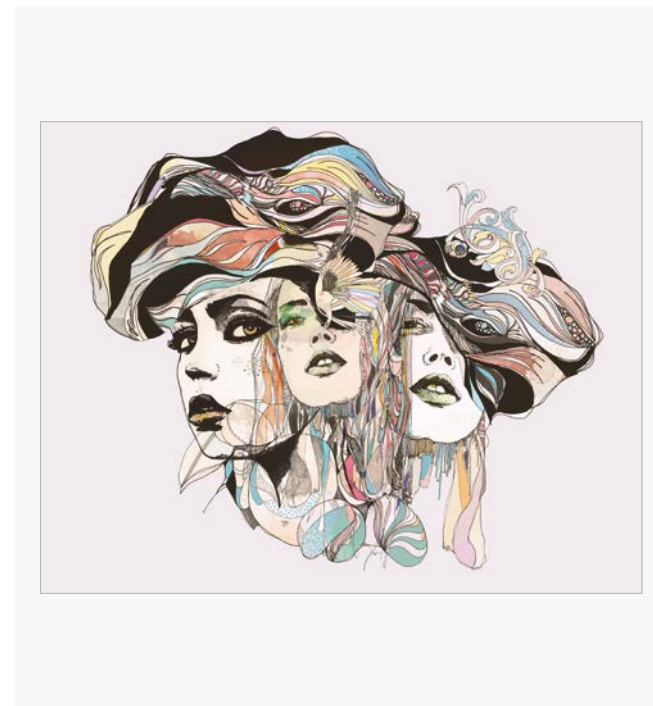

GI-029

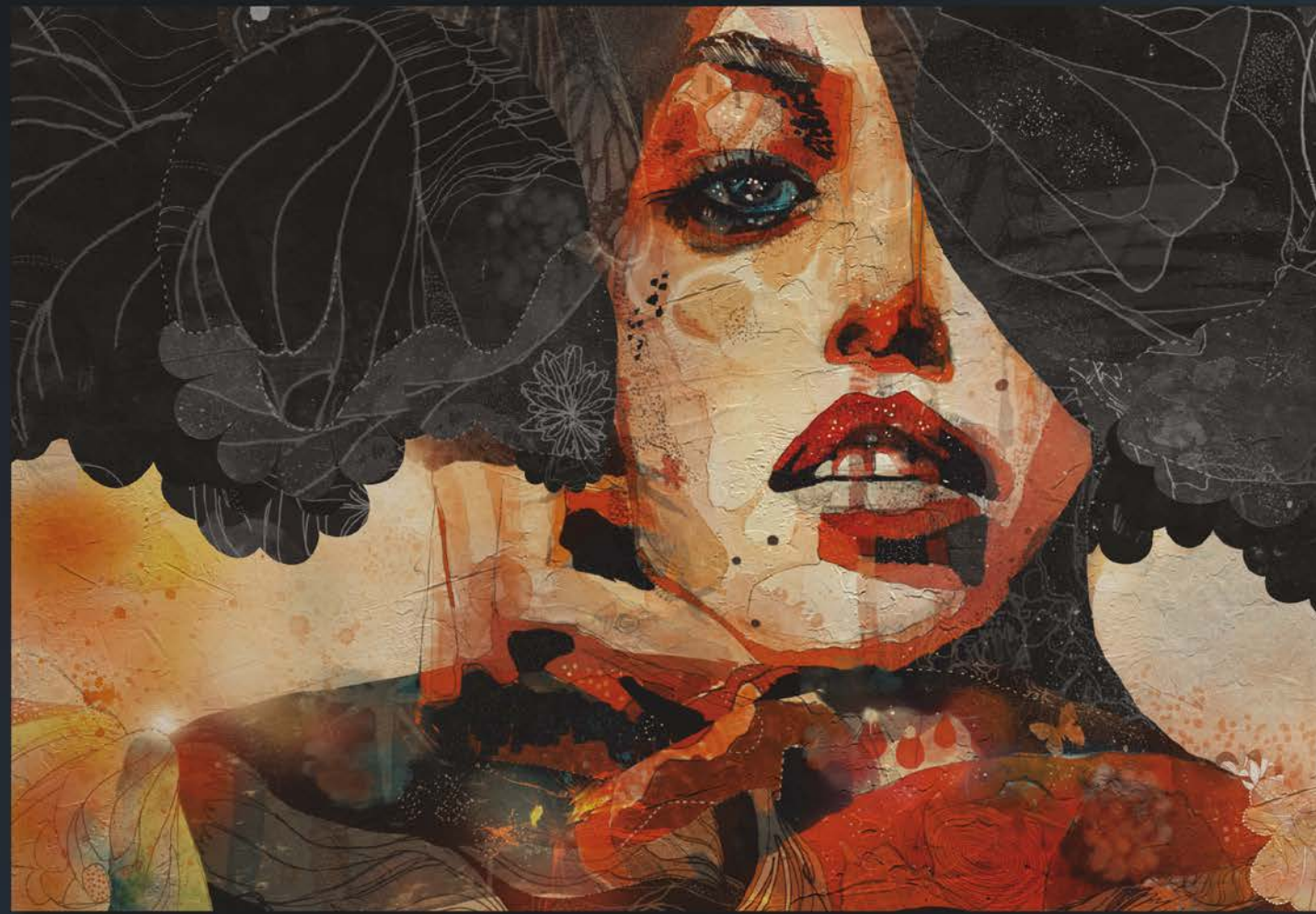

Artist: Giulio Lurissevich

Artist: Giulio Lurissevich

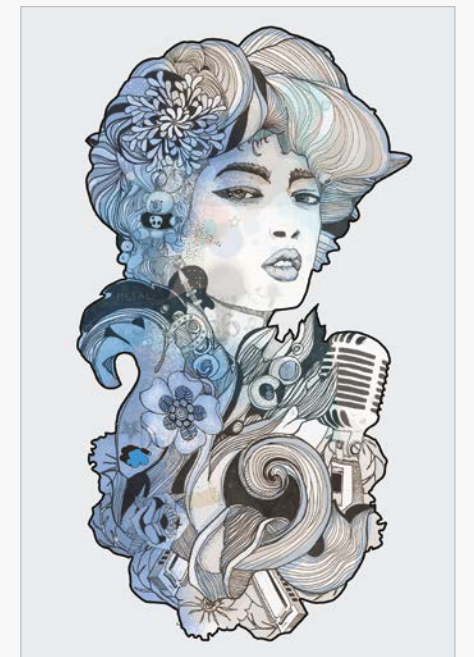
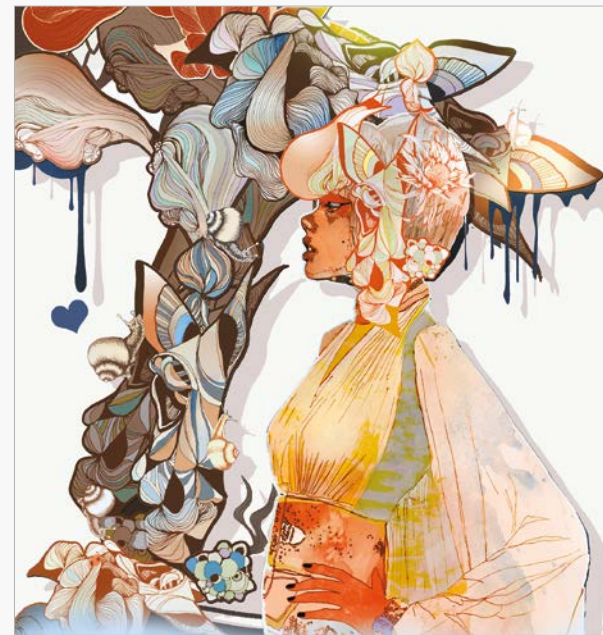

GI-030

GI-031

Artist: Giulio Lurissevich

Artist: Giulio Lurissevich

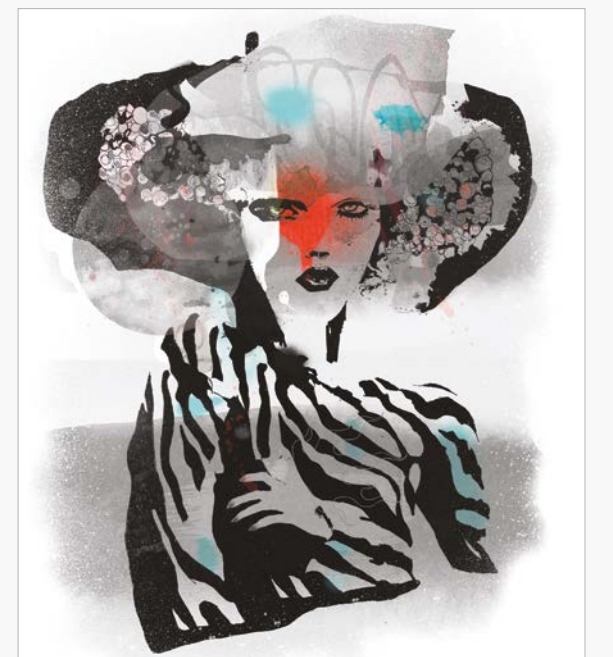

GI-033

GI-035



Artist: Giulio Iurissevich

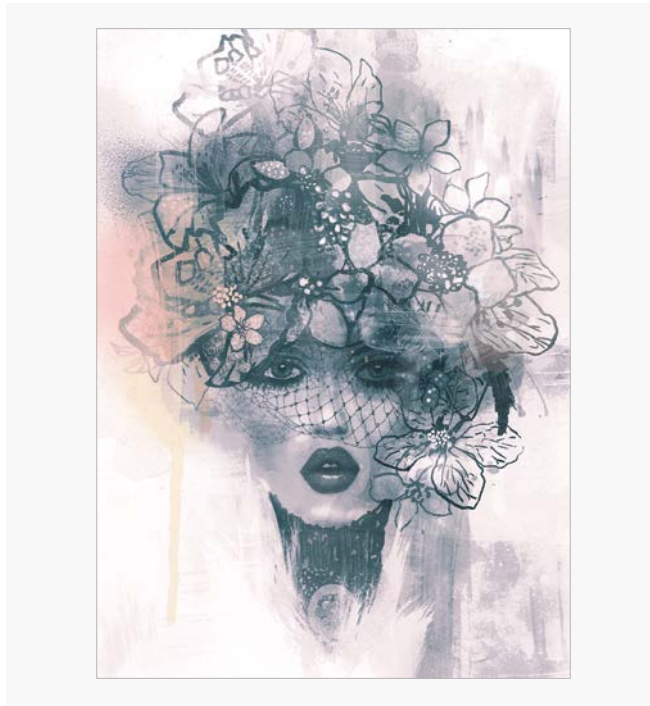

GI-036

Artist: Giulio Iurissevich

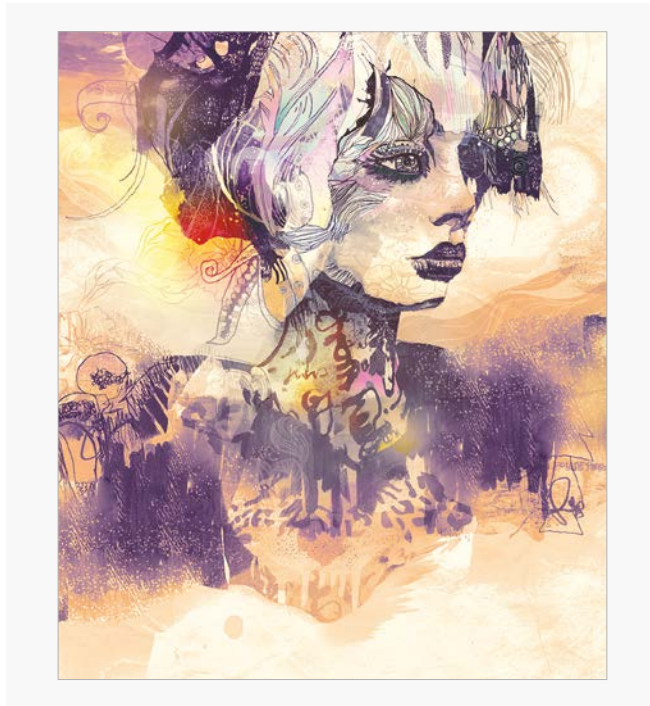

GI-037

Artist: Giulio Iurissevich

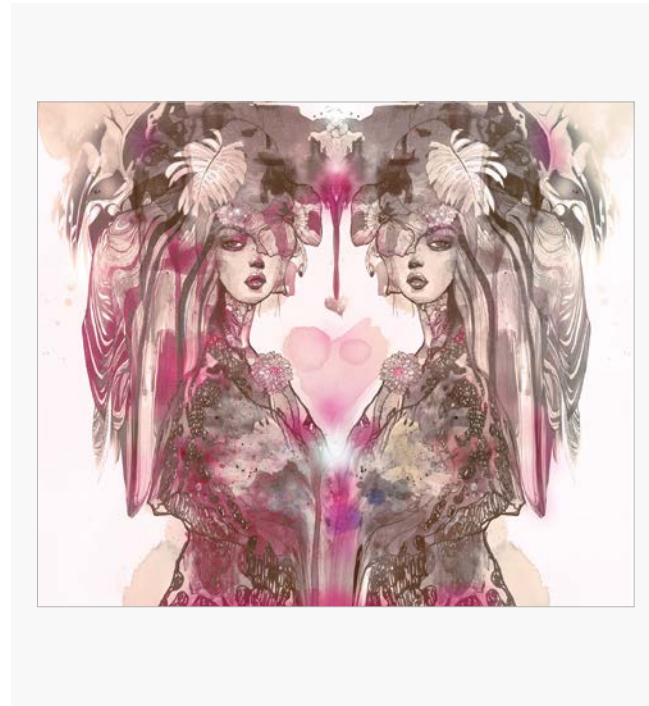

GI-041

Artist: Giulio Iurissevich

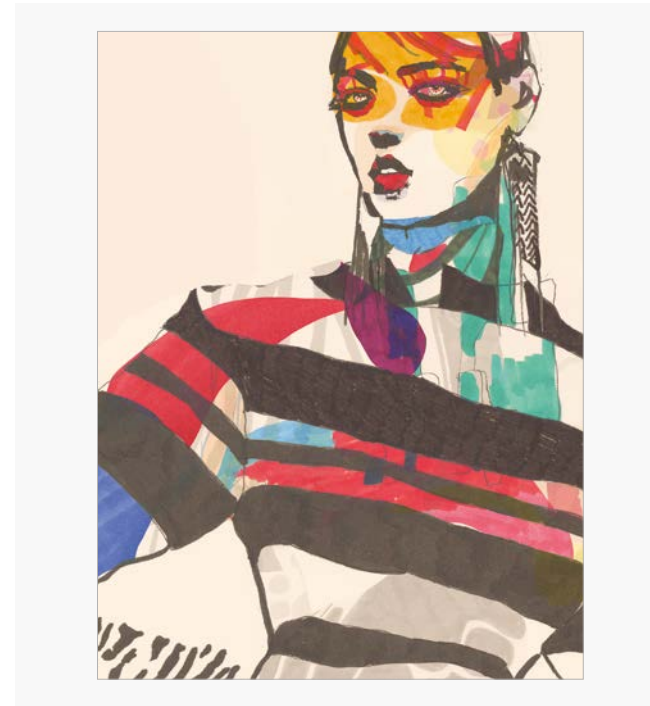

GI-042

Artist: Giulio Iurissevich

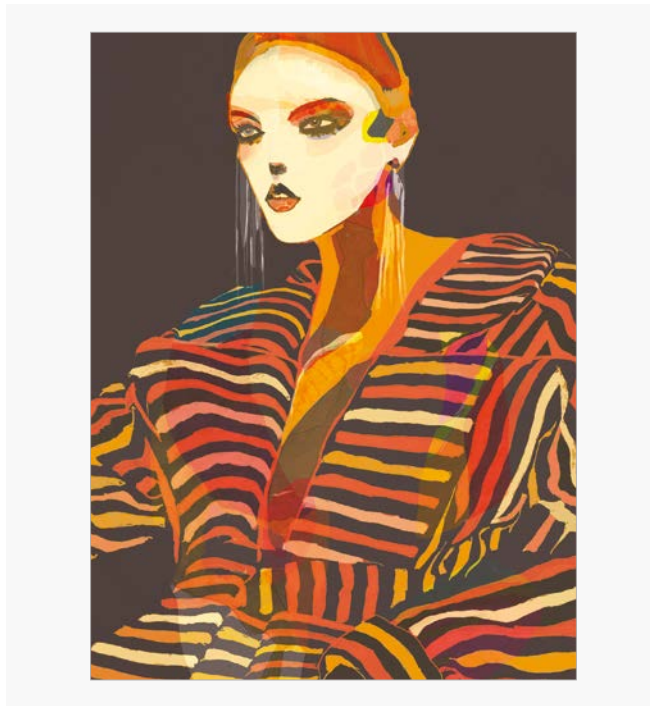

GI-038

Artist: Giulio Iurissevich

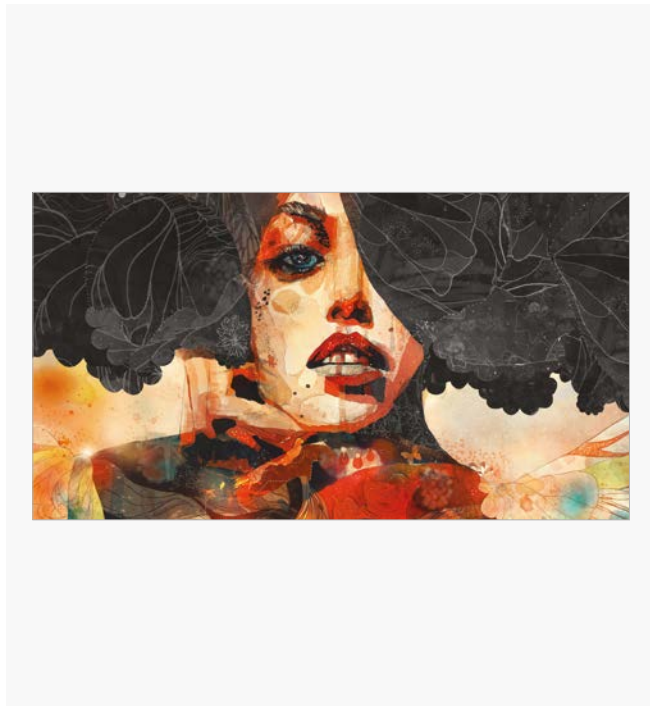

GI-039

Artist: Giulio Iurissevich

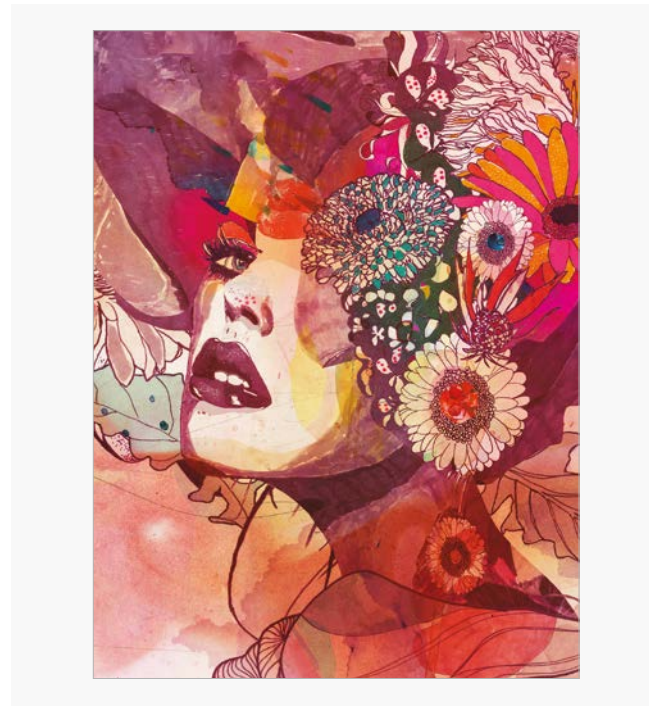

GI-043

Artist: Giulio Iurissevich

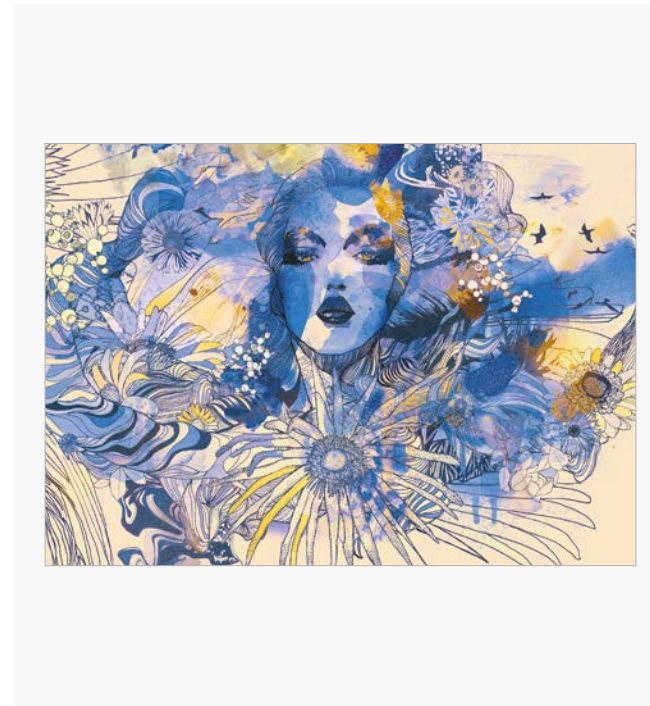

GI-044

Artist: Giulio Lurissevich

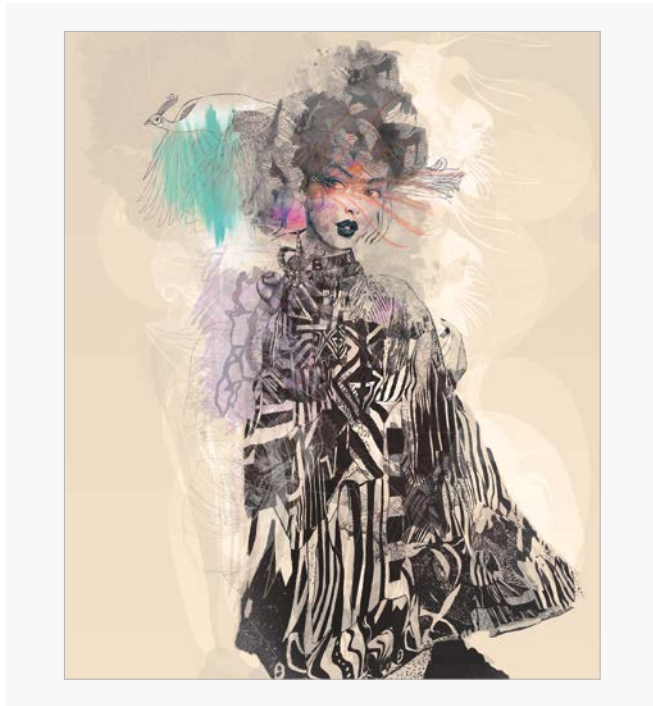

GI-045

Artist: Giulio Lurissevich

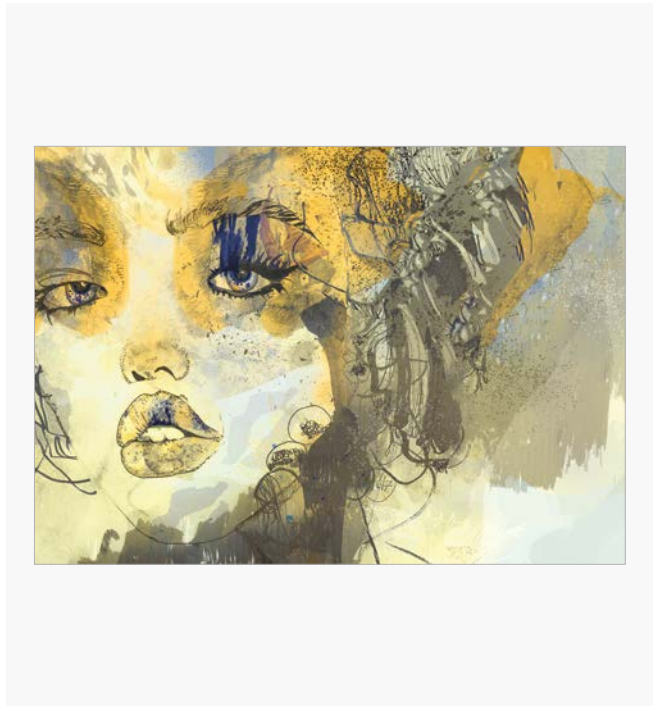

GI-046

Artist: Giulio Lurissevich



GI-051

Artist: Giulio Lurissevich

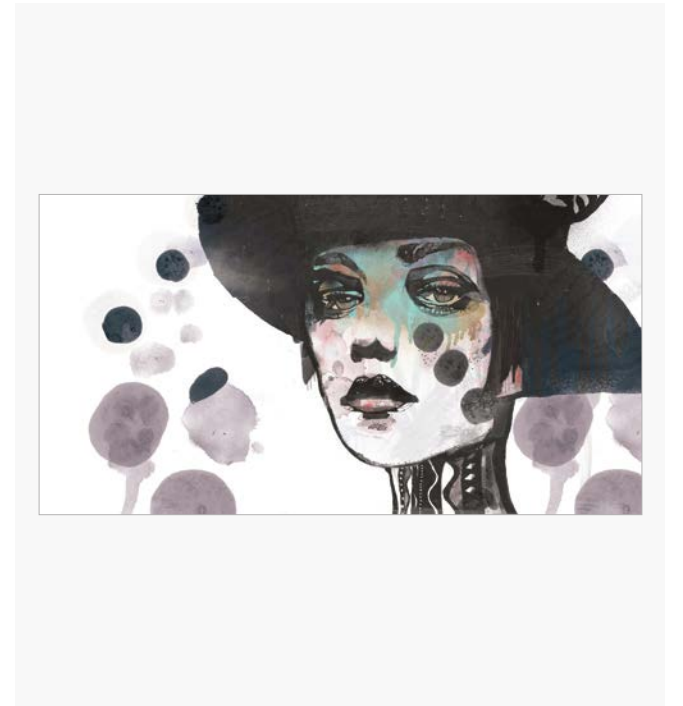

GI-052

Artist: Giulio Lurissevich

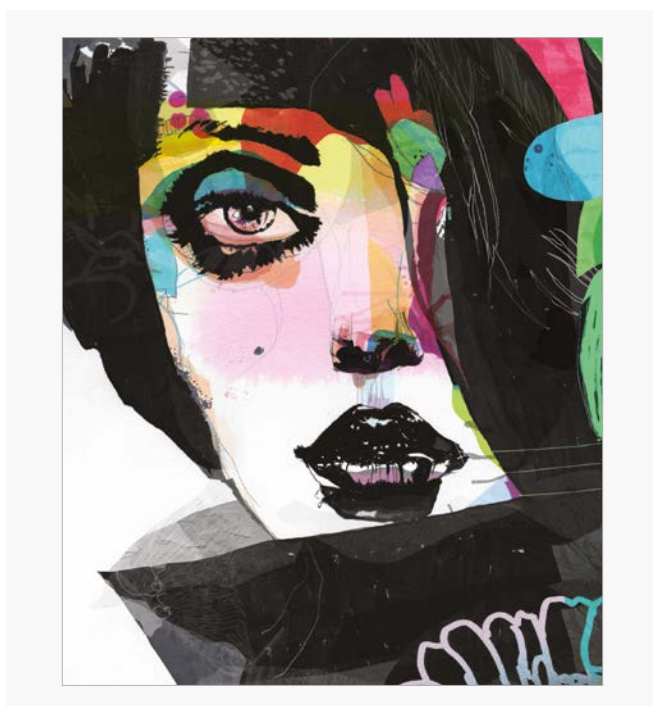

GI-049

Artist: Giulio Lurissevich

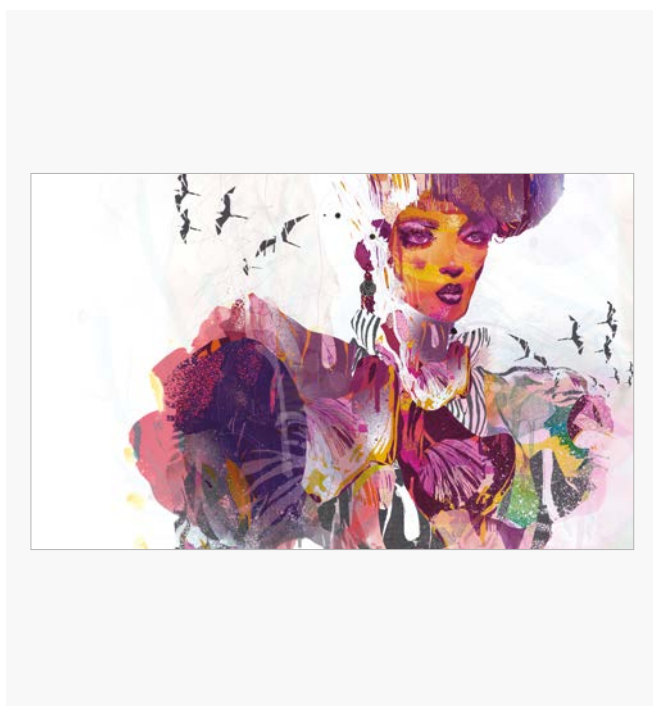

GI-050

Artist: Giulio Lurissevich

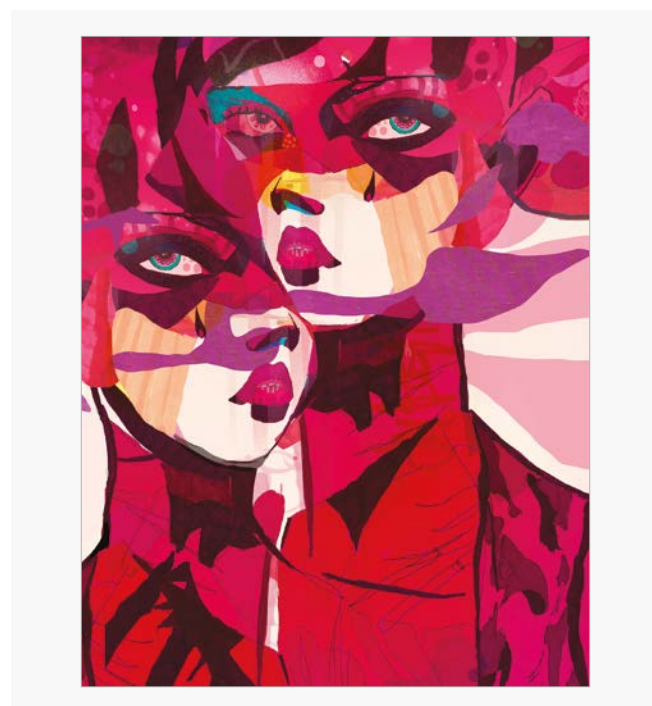

GI-053

Artist: Giulio Lurissevich

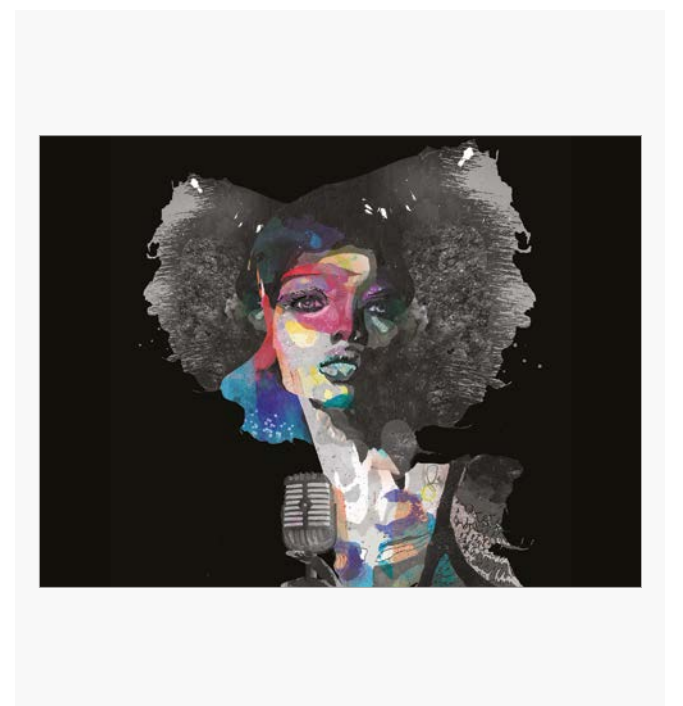

GI-054

Artist: Giulio Iurissevich

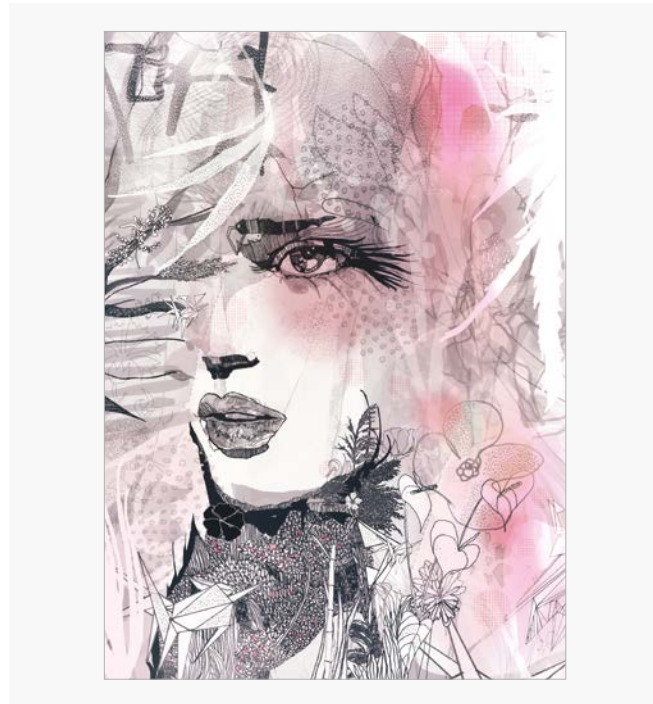

GI-055

Artist: Giulio Iurissevich

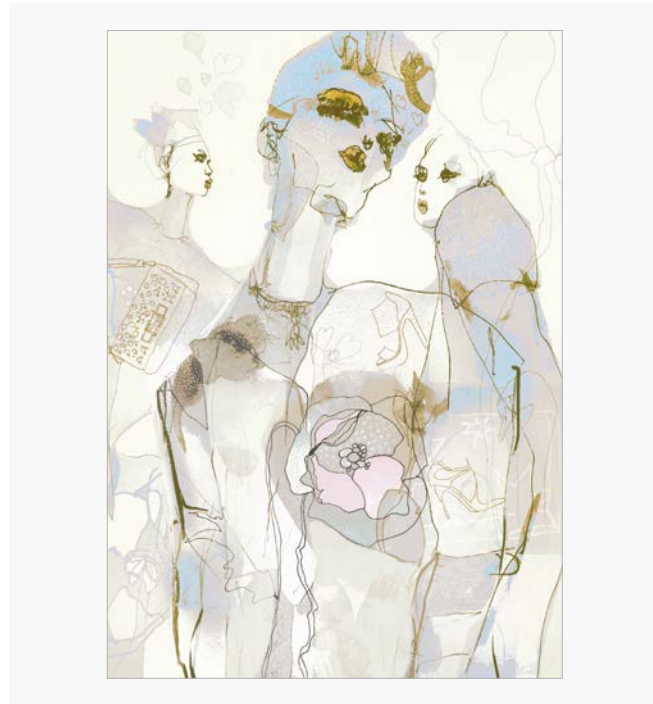

GI-056

Artist: Giulio Iurissevich

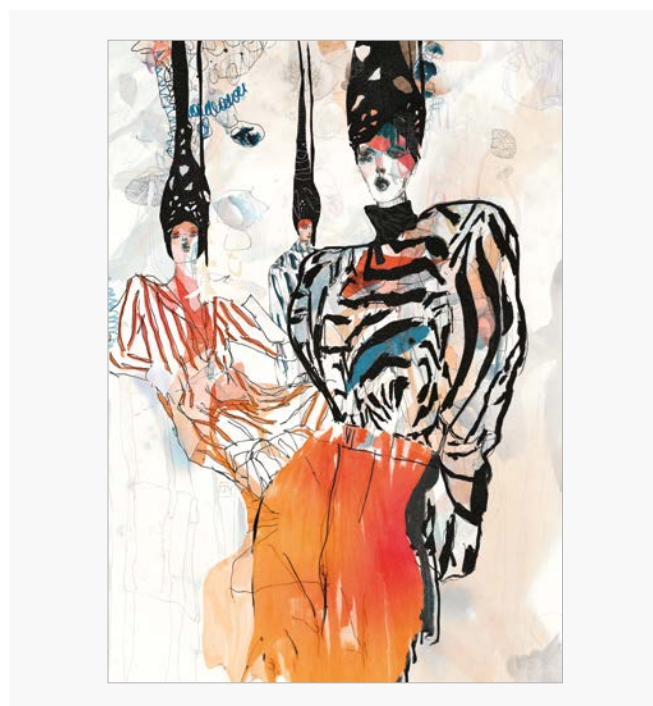

GI-057

Artist: Giulio Iurissevich

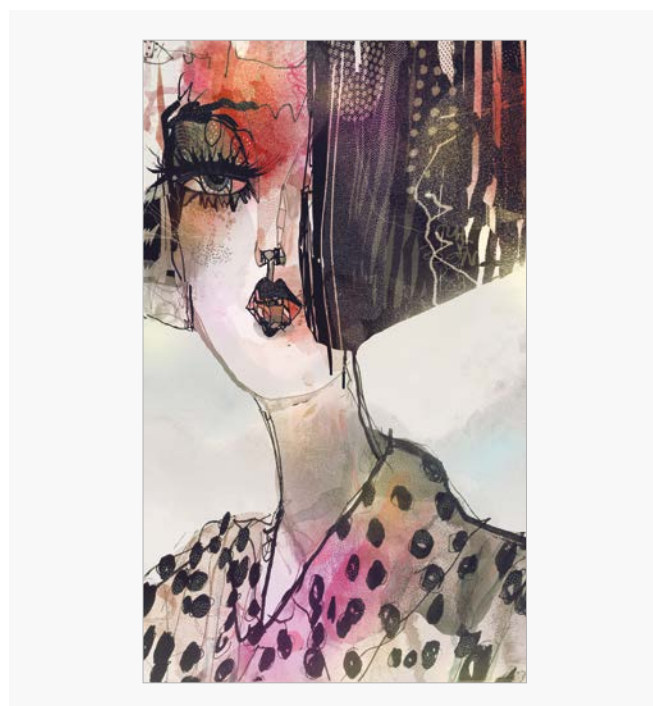

GI-058



Artist: Giulio Lurissevich

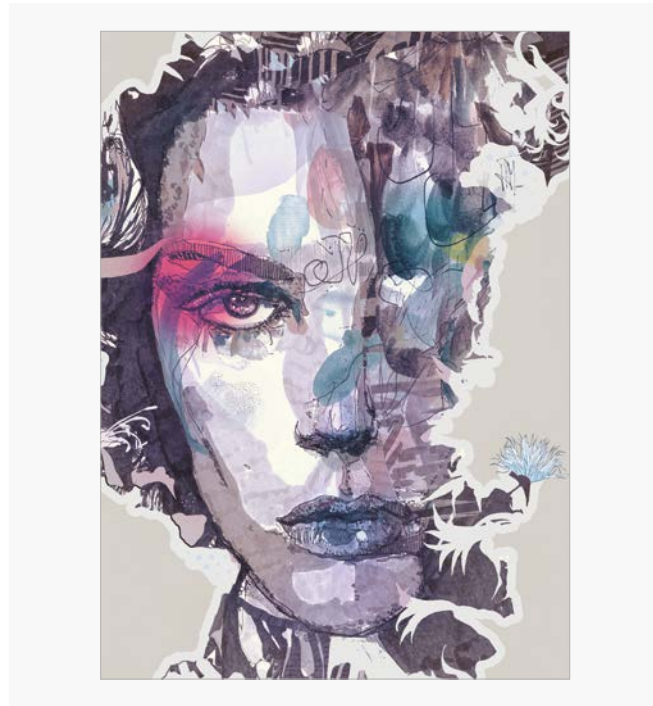

GI-059

Artist: Giulio Lurissevich

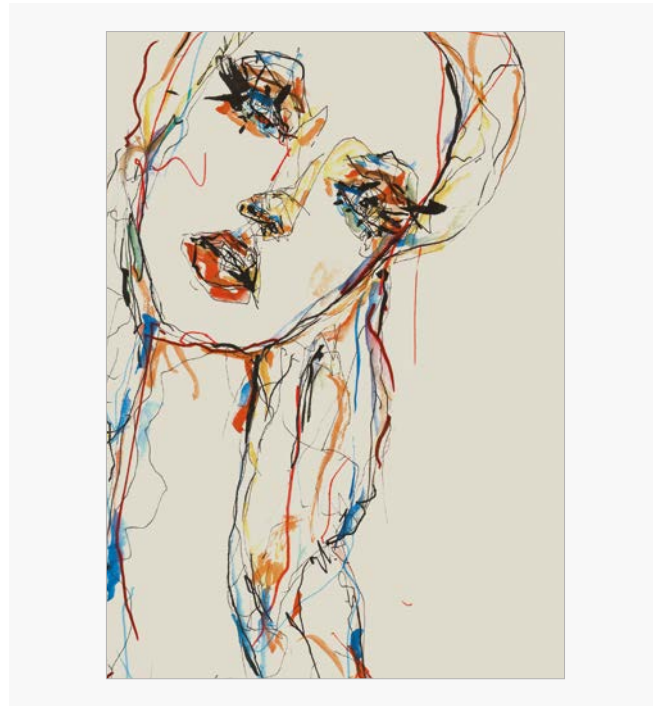

GI-060

Artist: Giulio Lurissevich

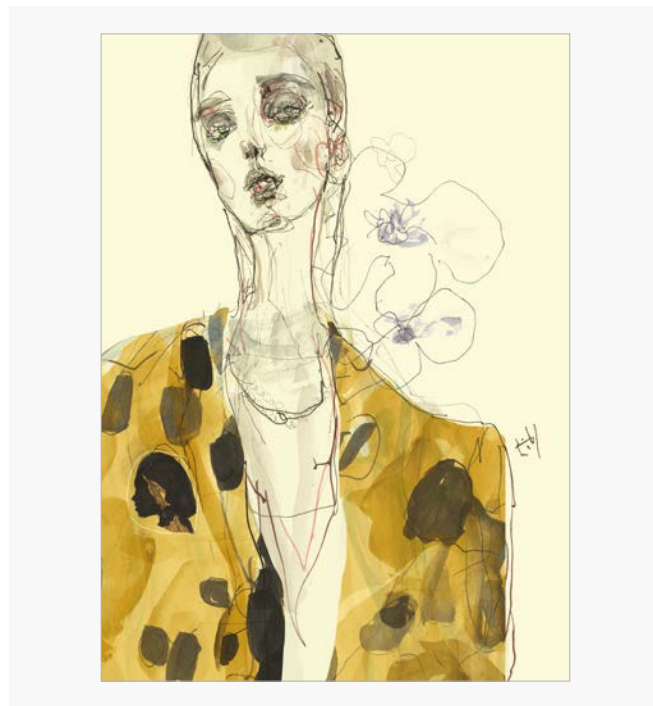

GI-061

Artist: Giulio Lurissevich

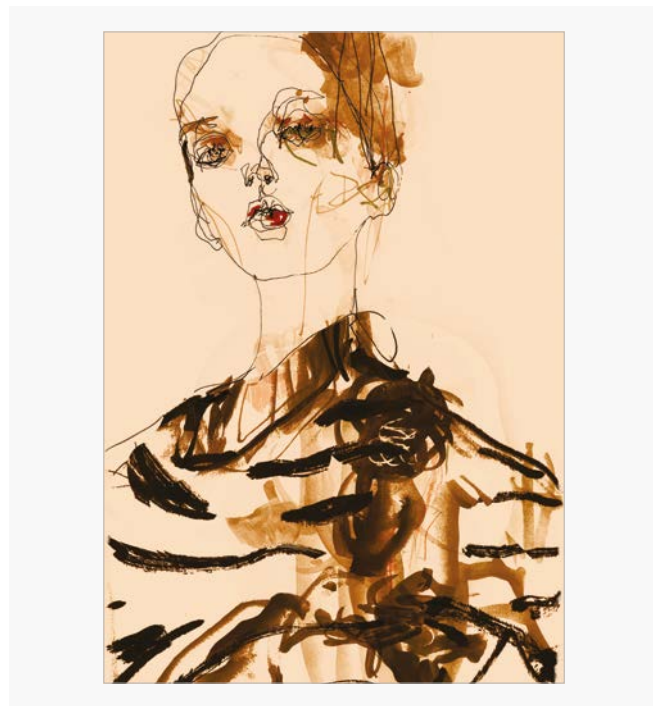

GI-062

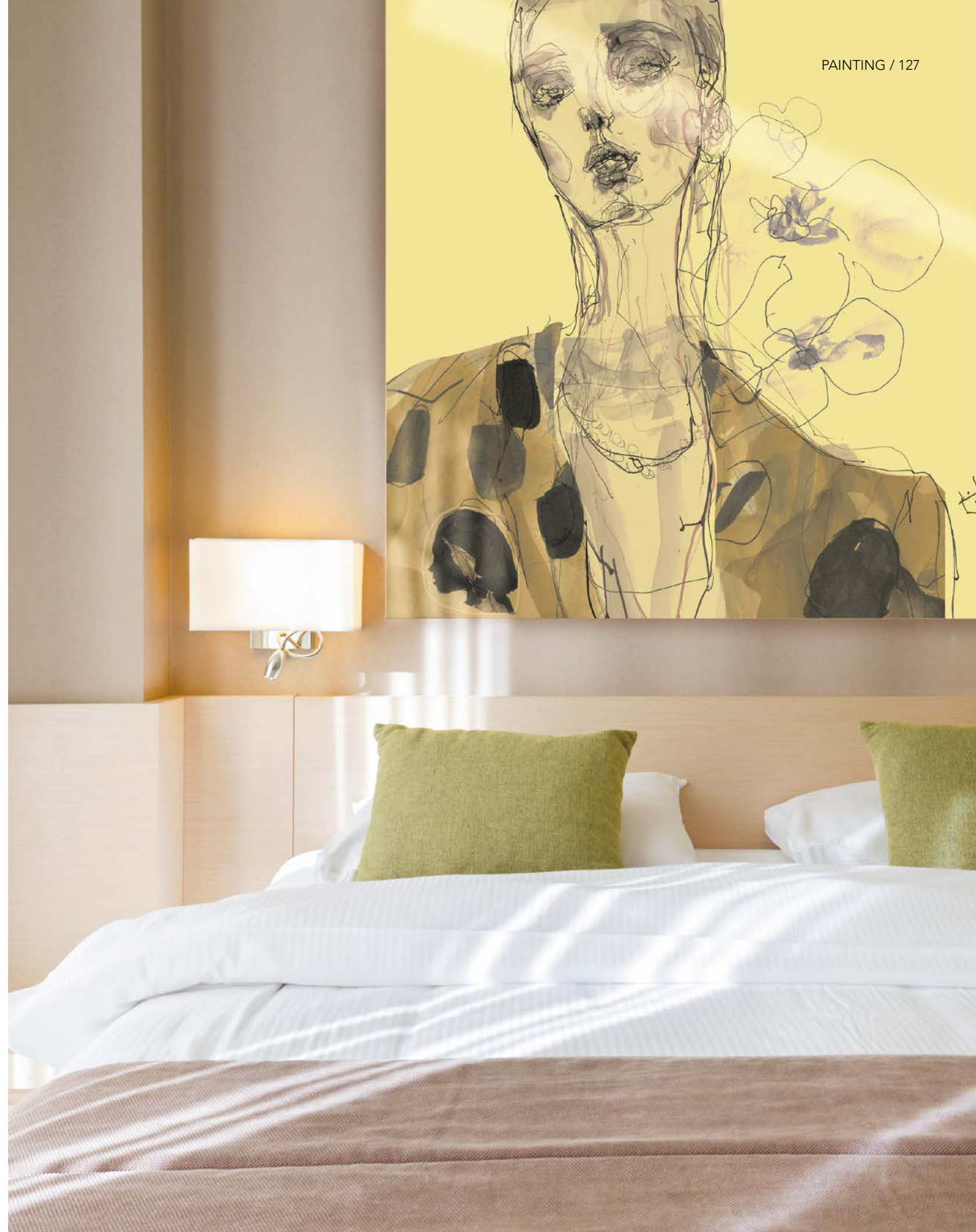

Artist: Giulio Lurissevich

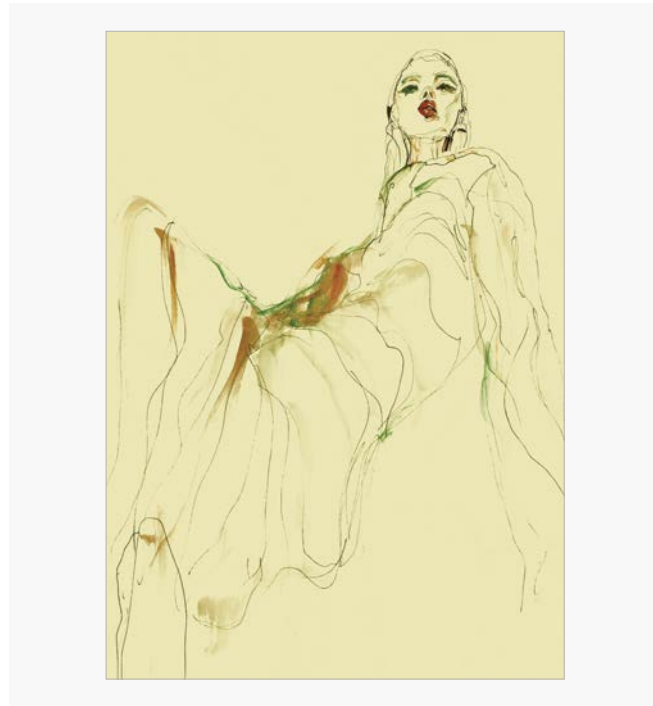

GI-063

Artist: Giulio Lurissevich

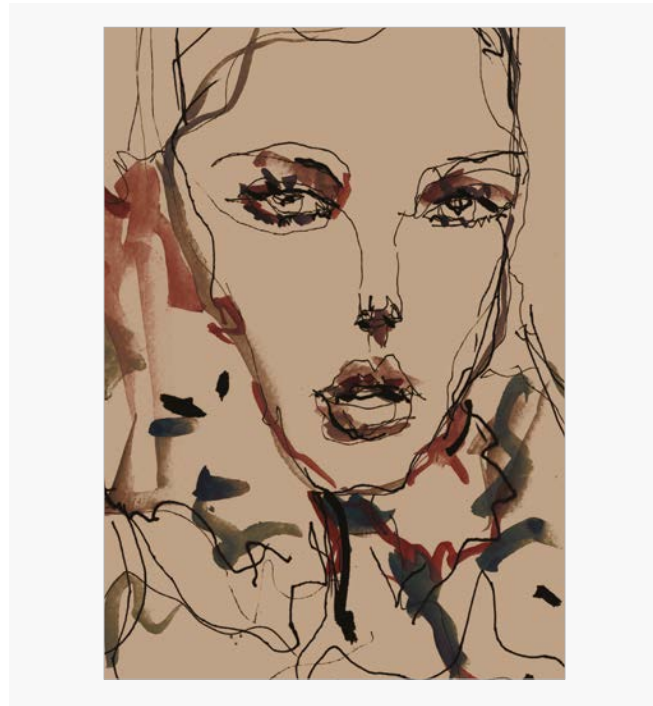

GI-065

Artist: Giulio Lurissevich

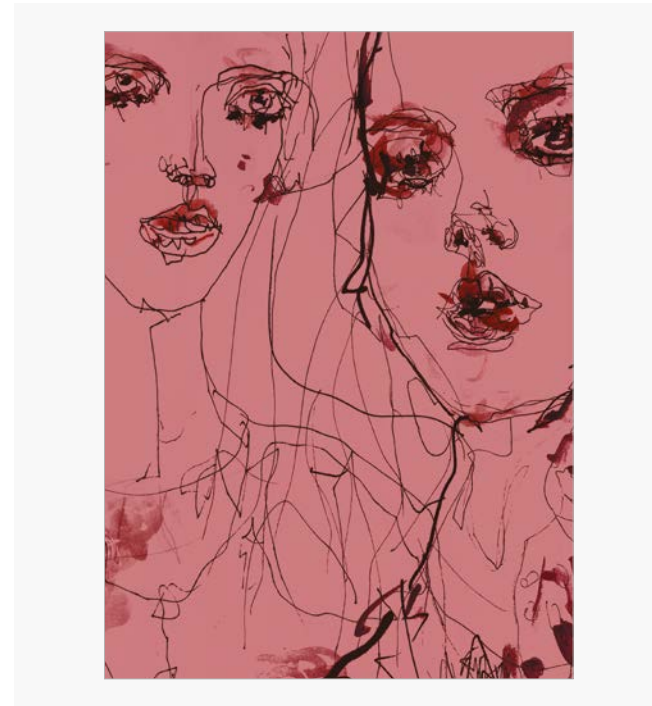

GI-069

Artist: Giulio Lurissevich

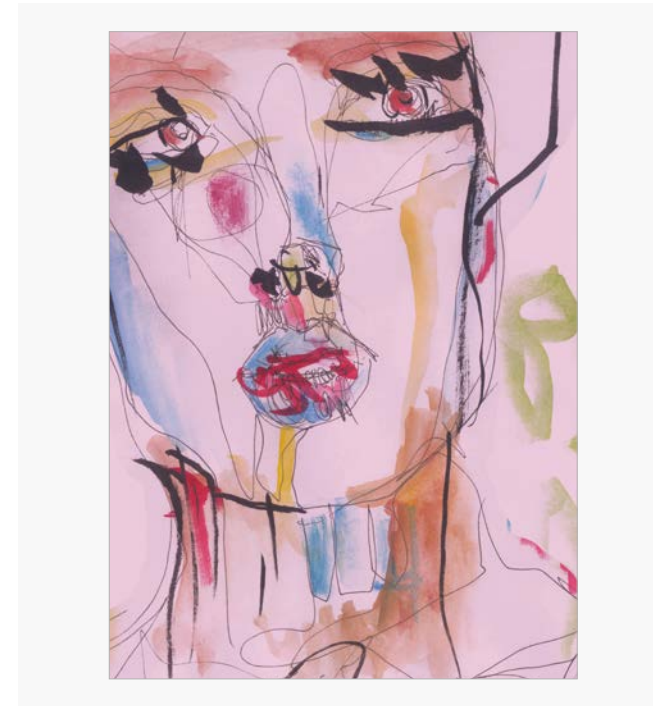

GI-070

Artist: Giulio Lurissevich

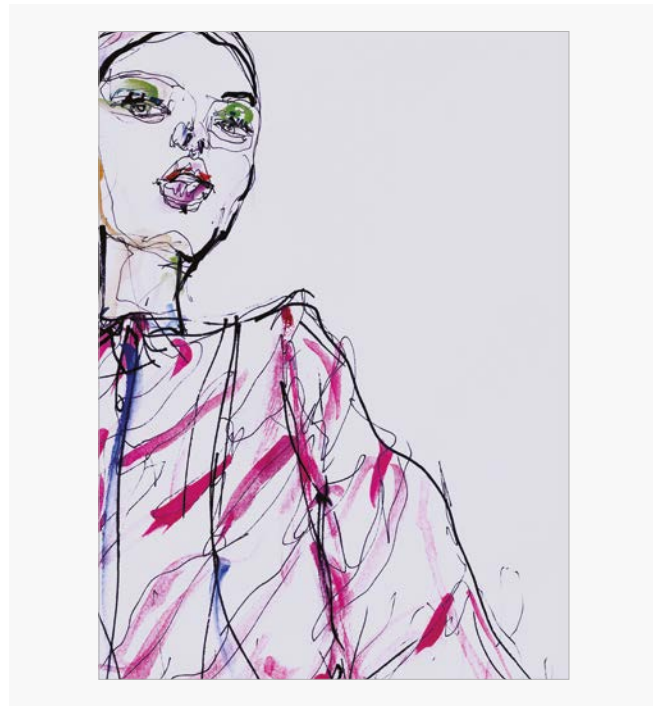

GI-067

Artist: Giulio Lurissevich

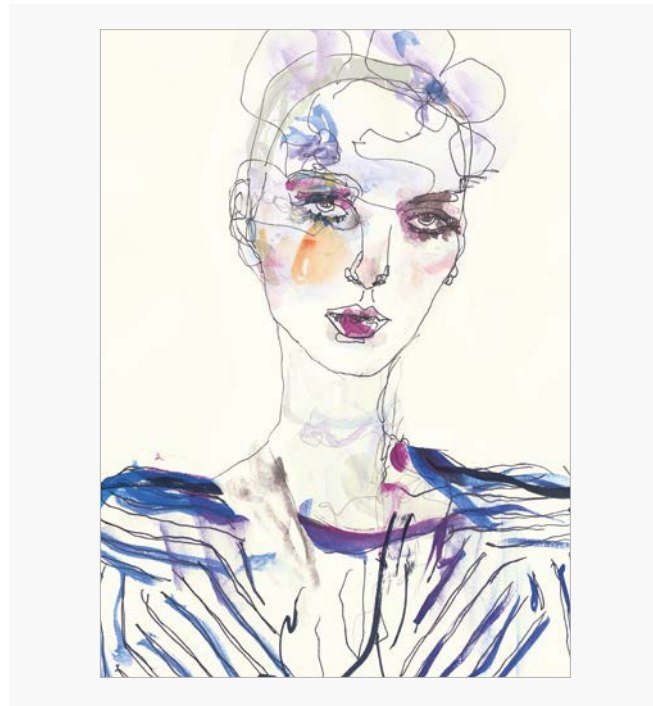

GI-068

Artist: Giulio Lurissevich

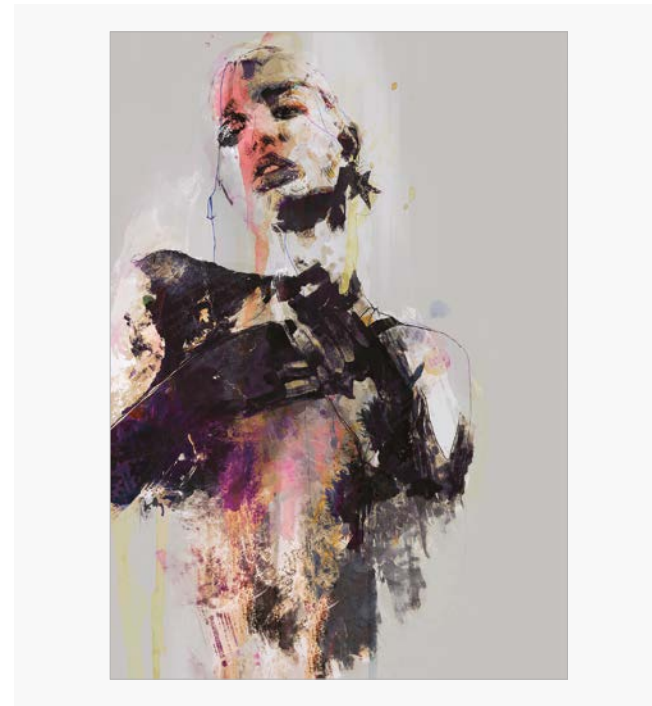

GI-071

Artist: Giulio Lurissevich

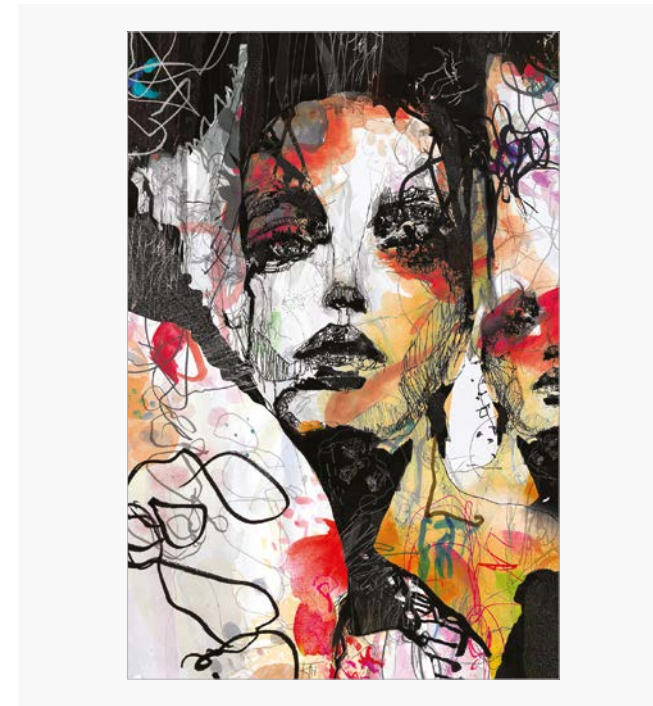

GI-072

Artist: Giulio Iurissevich

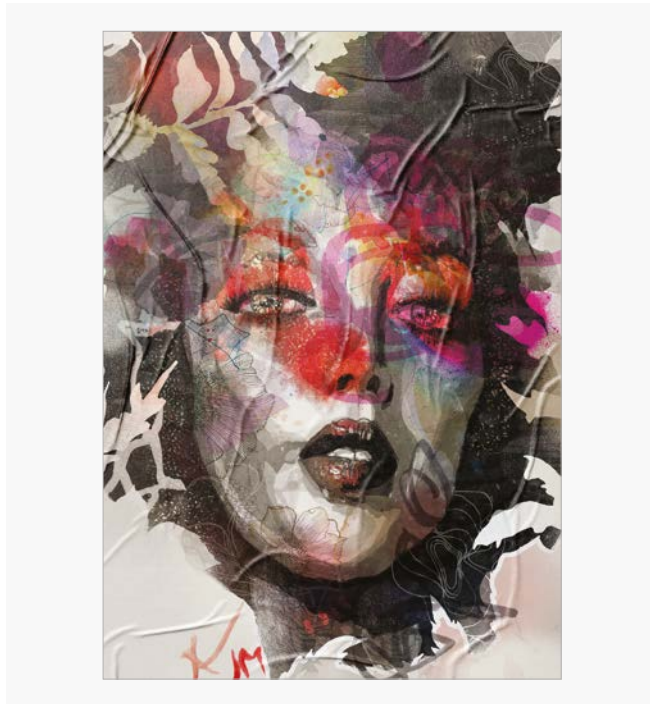

GI-073

Artist: Giulio Iurissevich

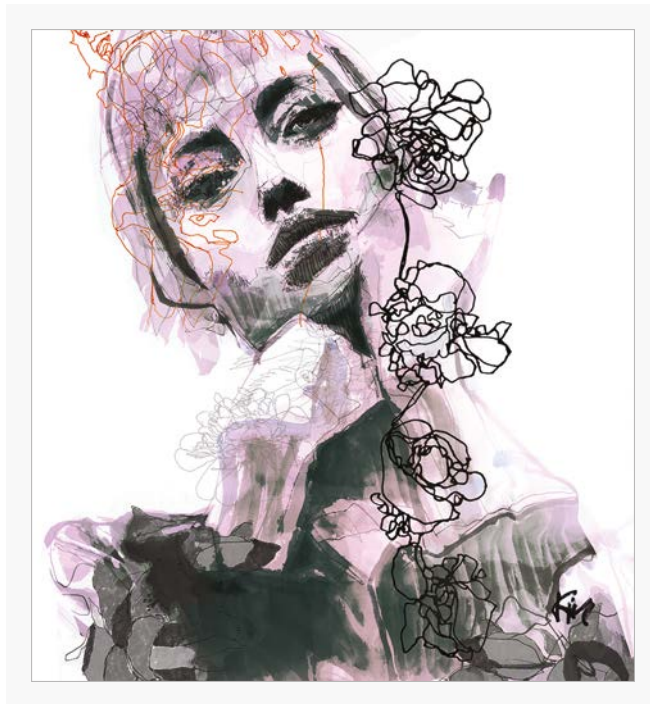

GI-075

Artist: Giulio Iurissevich

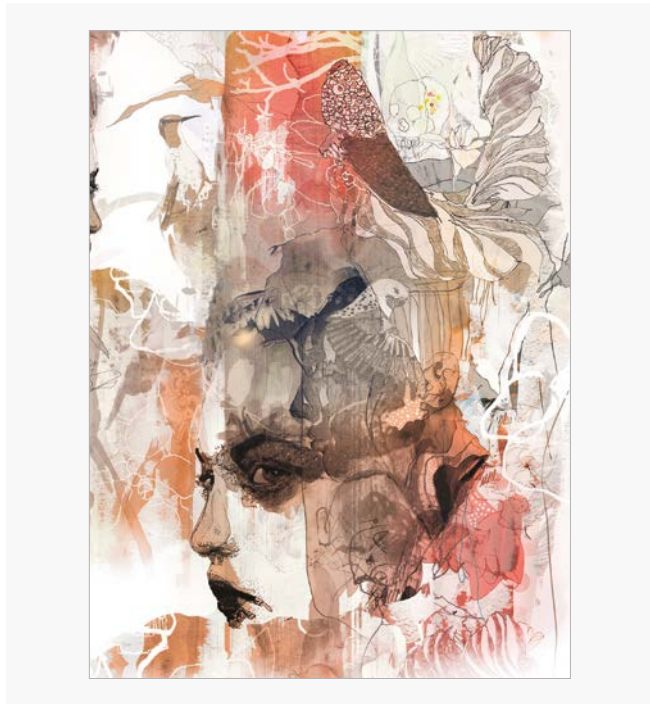

GI-074

Artist: Giulio Iurissevich

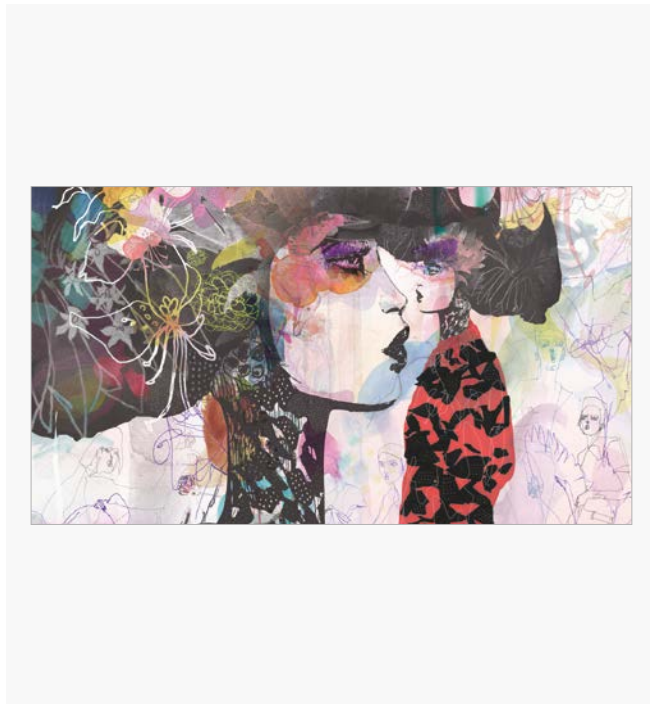

GI-076

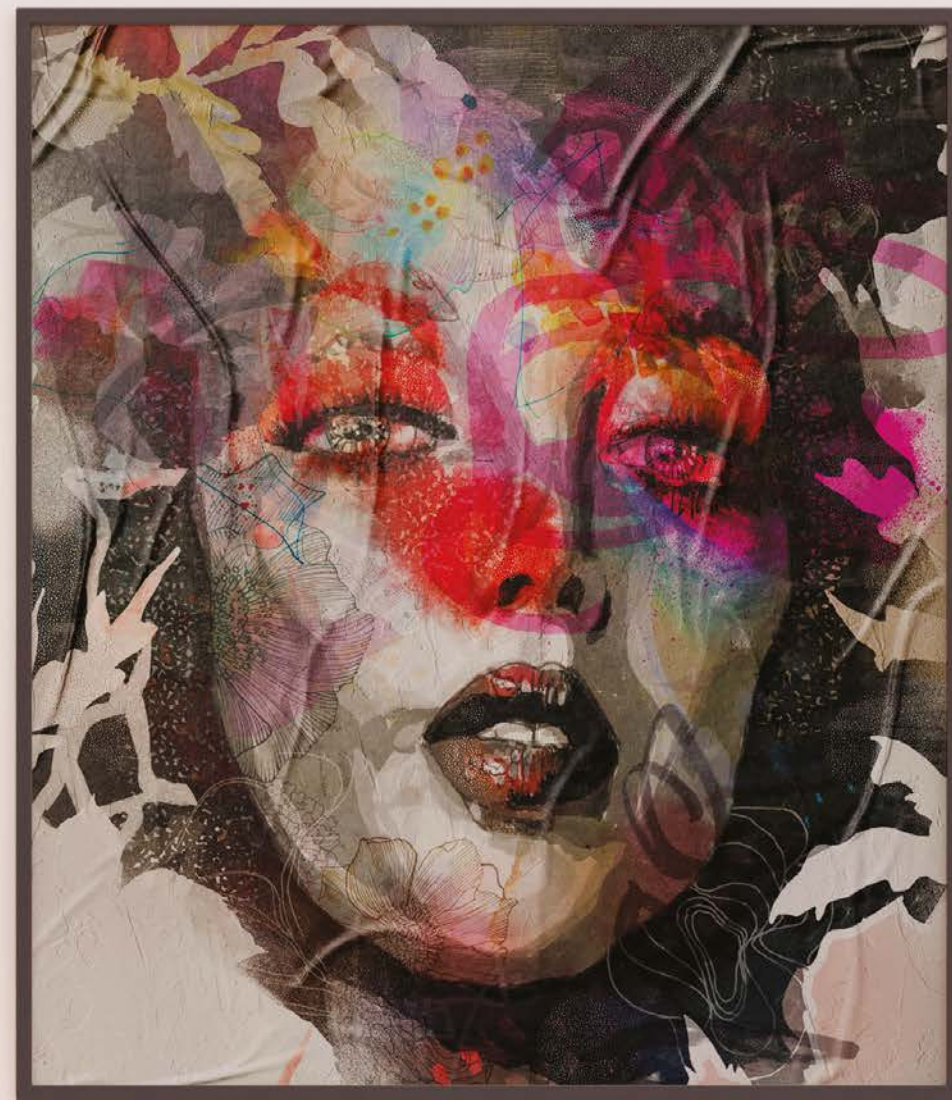

Ashima Kumar

Ashima Kumar è una graphic designer qualificata e artista visiva. Ha completato nel 1993 il suo Bachelor of Fine Arts presso il College of Art, Delhi, India. Da allora, ha fondato il suo studio di design. I suoi lavori creativi sono un'esplorazione del mondo che la circonda. Ispirata dall'arte di Kalamkari e Zentangle, ha sviluppato il suo stile di arte contemporanea utilizzando penna, inchiostro e tecnologia per realizzare opere d'arte digitali. Il suo lavoro è un bell'esempio di cosa accade quando si abbinano forme pulite e forti con un messaggio potente, mostrando come l'arte visiva può ispirare ed essere un elemento vitale nella crescita delle imprese e anche nello stimolare le percezioni del pubblico in modi desiderabili. Il mio portafoglio di clienti di design include Pepsico, Coca cola, Plan International India per citarne alcuni. La mia arte non è stata solo esposta in mostre d'arte, ma ha anche toccato una corda con le organizzazioni che cercano di costruire/estendere la propria identità di marca.

"L'arte può penetrare nella parte più profonda di noi, dove non esistono parole." (Ashima)

/ Ashima Kumar is a skilled graphic designer and visual artist. He completed his Bachelor of Fine Arts in 1993 at the College of Art, Delhi, India. Since then, he has founded his own design studio. Her creative works are an exploration of the world around her. Inspired by Kalamkari and Zentangle, she developed her style of contemporary art using pen, ink and technology to create digital artwork. His work is a fine example of what happens when you combine clean, strong forms with a powerful message, showing how visual art can inspire and be a vital element in business growth and also in stimulating public perceptions in ways desirable. My portfolio of design clients includes Pepsico, Coca cola, Plan International India to name a few. My art has not only been published in art exhibitions, it has also told a chord with organizations looking to build / extend their brand identity.

"Art can penetrate the very deepest part of us, where no words exist."(Ashima)

Artist: Ashima Kumar

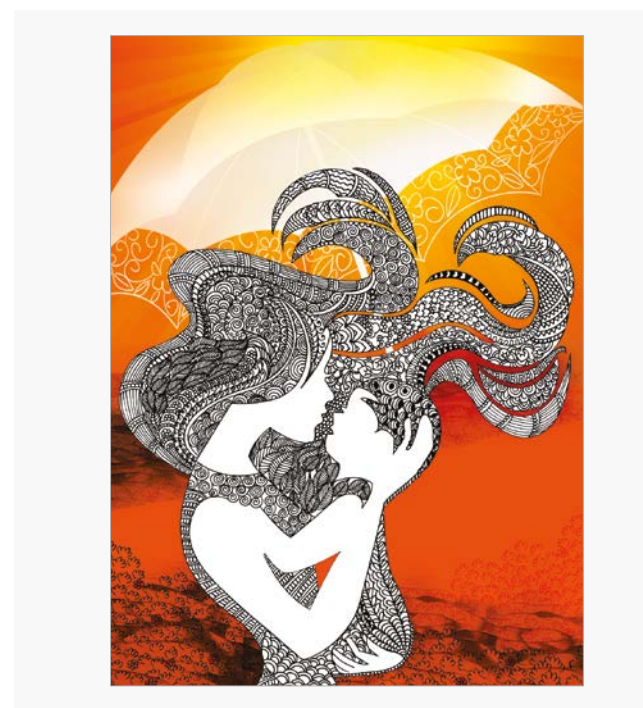

AH-001

Artist: Ashima Kumar

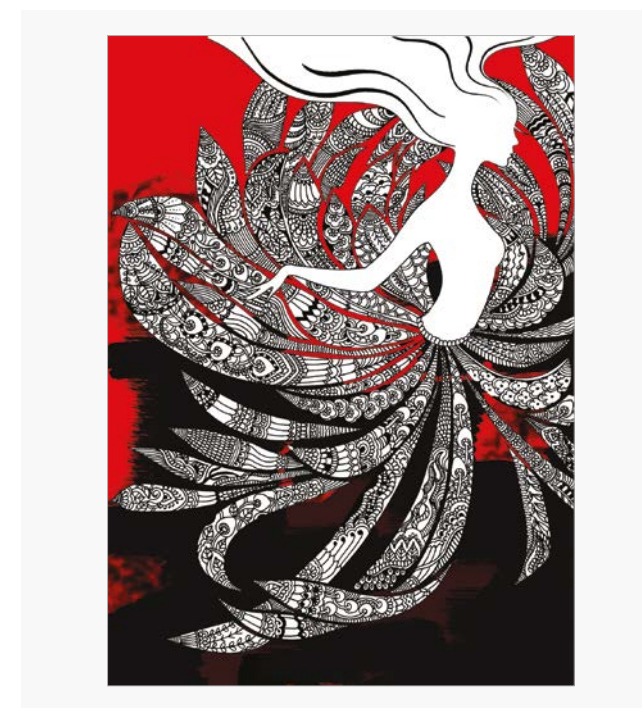

AH-002

Artist: Ashima Kumar

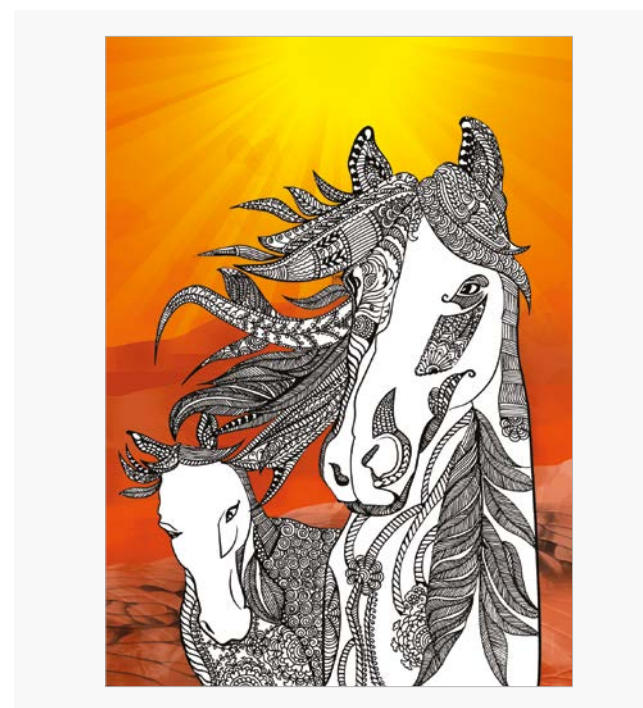

AH-007

Artist: Ashima Kumar

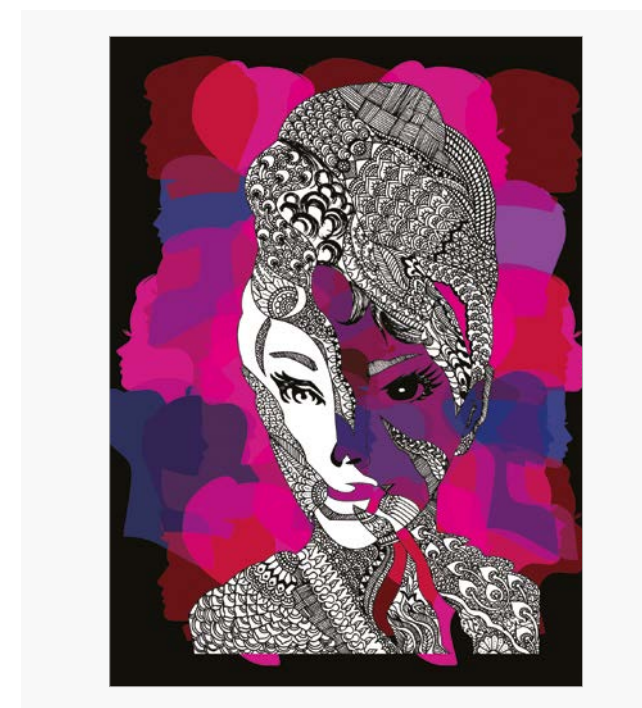

AH-010

Artist: Ashima Kumar



AH-012

Artist: Ashima Kumar



AH-015

Artist: Ashima Kumar



AH-016

Artist: Ashima Kumar

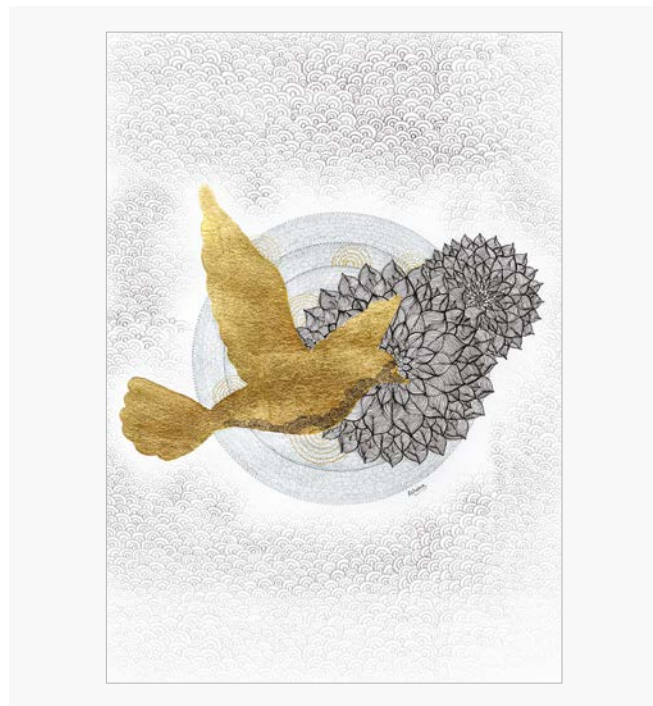

AH-017



Samuele Manz-ù Manzoni

Samuele Manzoni, in arte Manz-ù, fotografo professionista classe 1983, è specializzato in fotografia di moda. Ha realizzato campagne pubblicitarie e cataloghi collaborando con importanti agenzie, aziende ed editori di Milano, Lugano, New York, Miami, Parigi, Londra, Madrid, Dubai, Tokyo.

“Ogni buona fotografia racchiude in sé almeno due storie: la storia che rappresenta e la storia di chi la racconta. La fotografia di Samuele Manzoni di storie ne racconta almeno tre. La prima narra un viaggio elegante nel mondo del fashion. Un viaggio alla ricerca di personalità forti, di abiti raffinati e ricchi nei dettagli. La seconda è quella di un trentenne che con impegno e costanza è riuscito a padroneggiare in pochi anni la tecnica fotografica mantenendo un buon rapporto tra tradizione e sperimentazione. Infine, la terza storia è quella di uno stile unico che il fotografo sta costruendo e integrando scatto dopo scatto. Uno stile con influenze rococò, dove la formalità della fotografia minimale è messa al bando per dare spazio drappaggi e texture. Carisma, sì. Penso che la fotografia di Samuele Manzoni sia in toto un’esplosione di carisma.” (Elisa Contessotto- MeVsPhotography)

/ Samuele Manzoni, aka Manz-ù, professional photographer born in 1983, specializes in fashion photography. He has created advertising campaigns and catalogs collaborating with important agencies, companies and publishers in Milan, Lugano, New York, Miami, Paris, London, Madrid, Dubai, Tokyo.

“Every good photograph contains at least two stories: the story it represents and the story of the one who tells it. Samuele Manzoni’s photography of stories tells at least three. The first tells of an elegant journey into the world of fashion. A journey in search of strong personalities, refined clothes rich in details. The second is that of a thirty-year-old who with commitment and perseverance has managed to master the photographic technique in a few years while maintaining a good relationship between tradition and experimentation. Finally, the third story is that of a unique style that the photographer is building and integrating shot after shot. A style with Rococo influences, where the formality of minimal photography is outlawed to give space to drapes and textures. Charisma, yes. I think that Samuele Manzoni’s photography is an explosion of charisma in its entirety.” (Elisa Contessotto- MeVsPhotography)

Artist: Samuele Man-zù Manzoni



MZ-001

Artist: Samuele Man-zù Manzoni



MZ-002

Artist: Samuele Man-zù Manzoni



MZ-003

Artist: Samuele Man-zù Manzoni



MZ-004

Artist: Samuele Man-zù Manzoni

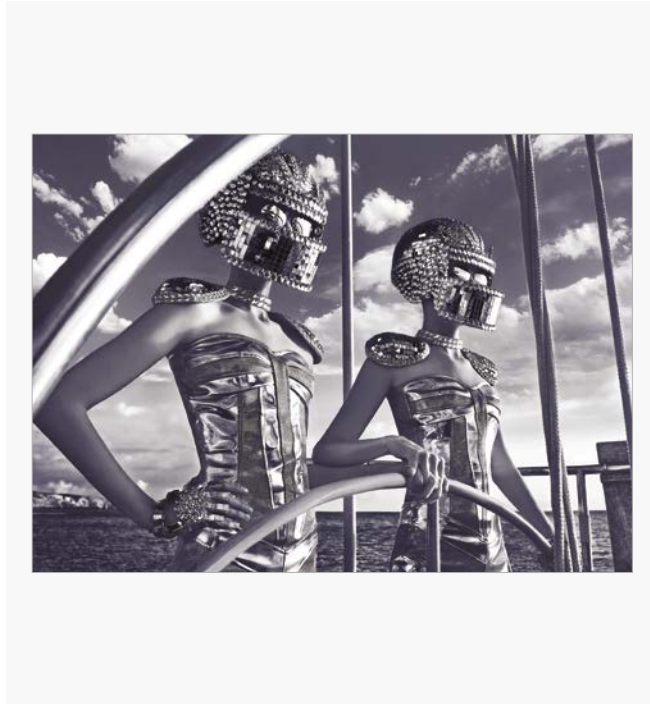

MZ-005

Artist: Samuele Man-zù Manzoni



MZ-008

Artist: Samuele Man-zù Manzoni



MZ-007

Artist: Samuele Man-zù Manzoni



MZ-009

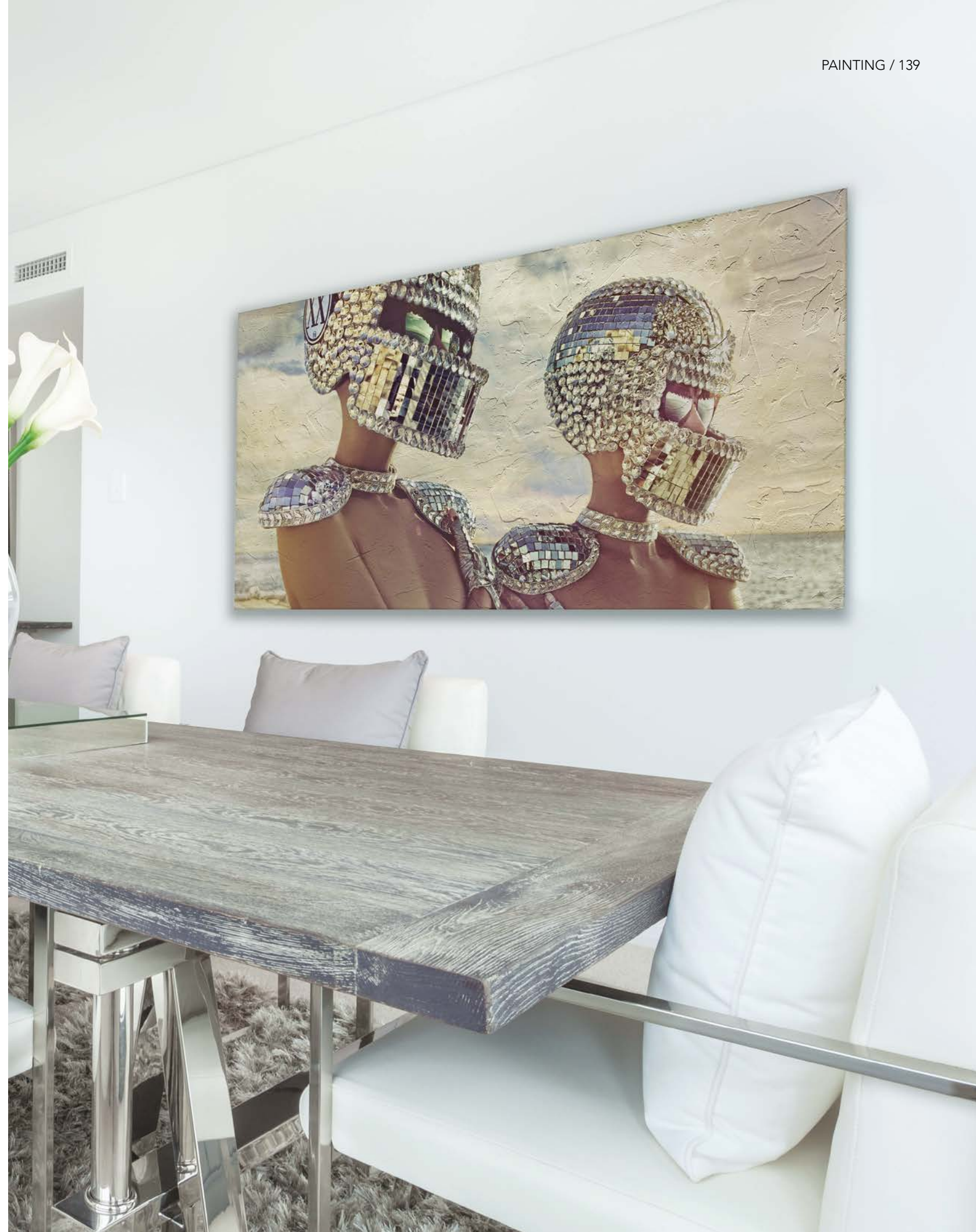

Luis Martin

Artist: Luis Martin

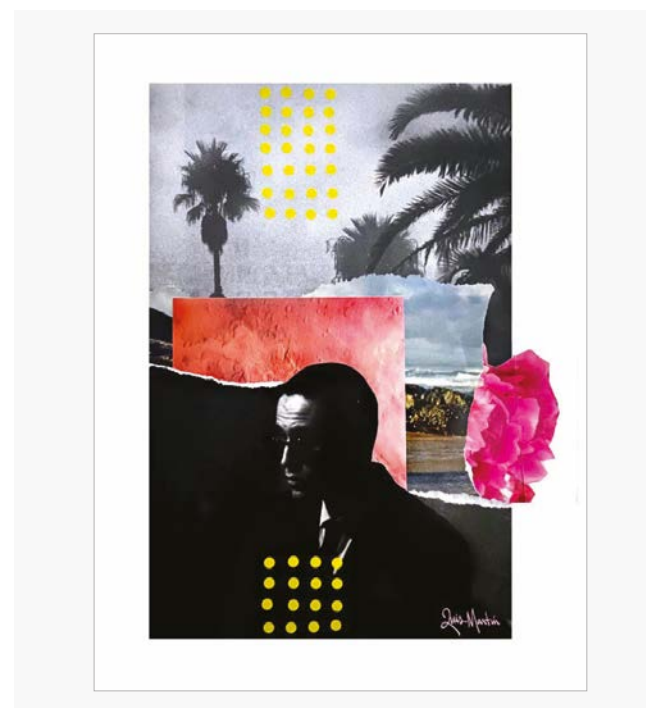

LM-001

Artist: Luis Martin

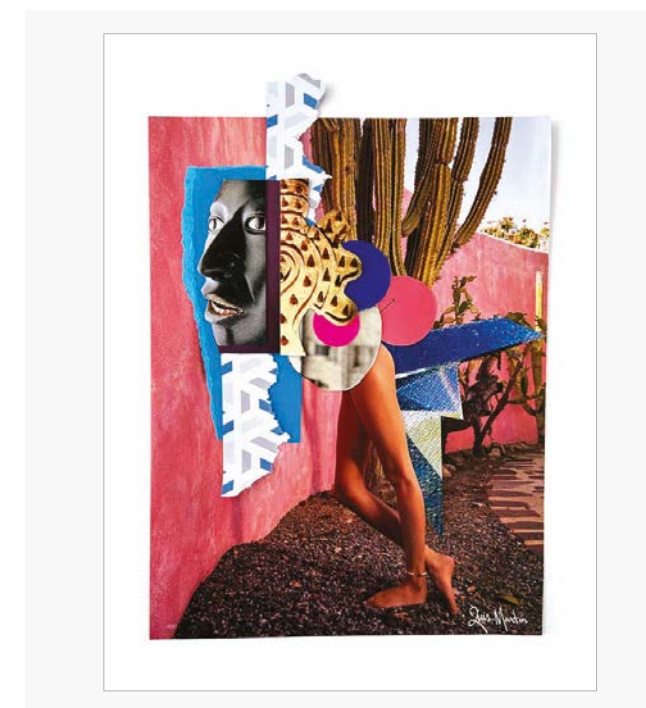

LM-002

Artist: Luis Martin

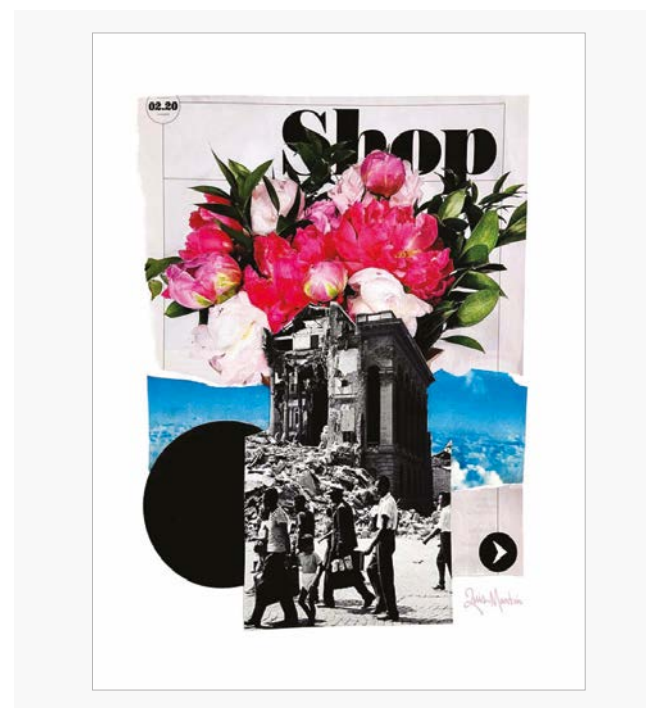

LM-003

Artist: Luis Martin

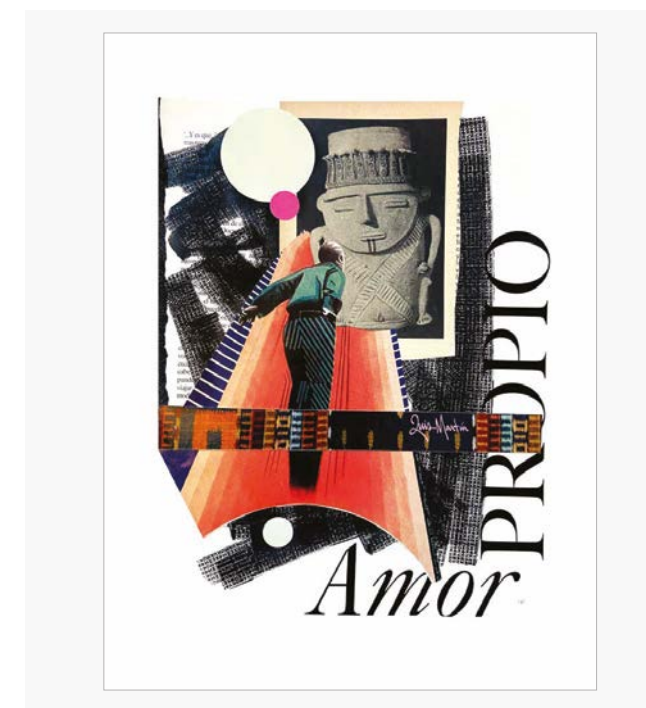

LM-004

Il mio lavoro di collage è un flusso di pratica di coscienza, che mi permette di esplorare le narrazioni che emergono dopo che ogni pezzo è stato completato. La mia appropriazione di ogni immagine mi dà il potere di mostrare il mio punto di vista molto personale con una miriade di sincronicità e codici del linguaggio visivo. Ho creato il termine "The Art Engineer" per ricordare a me stesso il potere che gli artisti hanno di "ingegnerizzare" e mostrare le possibilità di una realtà autodefinita. Creando conversazioni sull'identità e sull'eccesso della cultura pop, il mio lavoro diventa uno specchio che riflette il familiare in prospettive alterate.

/ Collage, to me, is the most democratic art practice one can create. It is political, accessible and spiritual. My collage work is a stream of conscience practice, that allows me to explore narratives that emerge after each piece is completed. My appropriation of each image gives me the power to show my very personal point of view with a myriad of synchronicities and codes visual language. I created the term "The Art Engineer" to remind myself of the power artists have to "engineer" and show the possibilities of a self defined reality. By creating conversation about identity and pop-culture's excess, my work becomes a mirror that reflects the familiar in altered perspectives.

Artist: Luis Martin

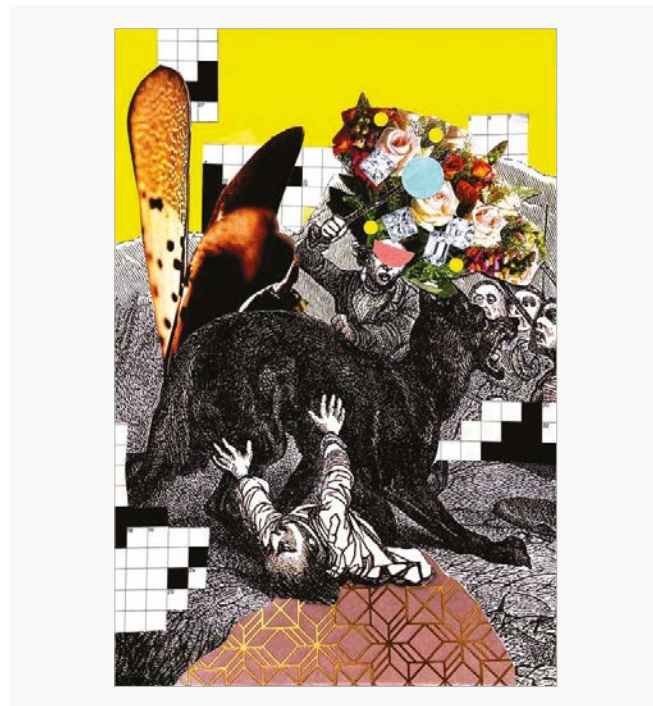

LM-005

Artist: Luis Martin

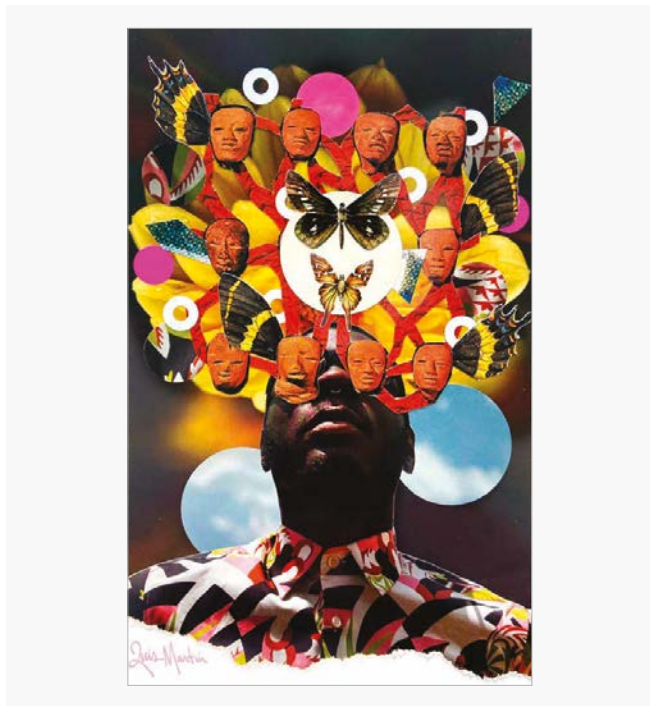

LM-006

Artist: Luis Martin

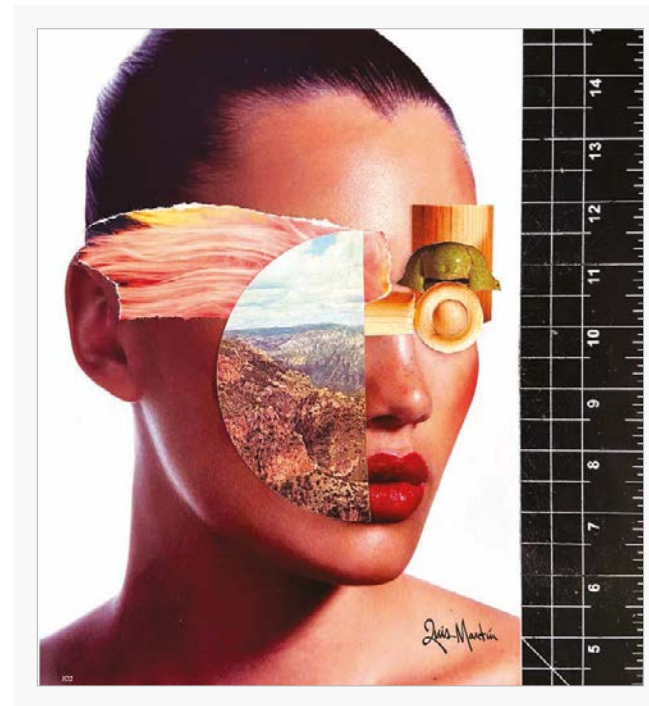

LM-009

Artist: Luis Martin



LM-010

Artist: Luis Martin

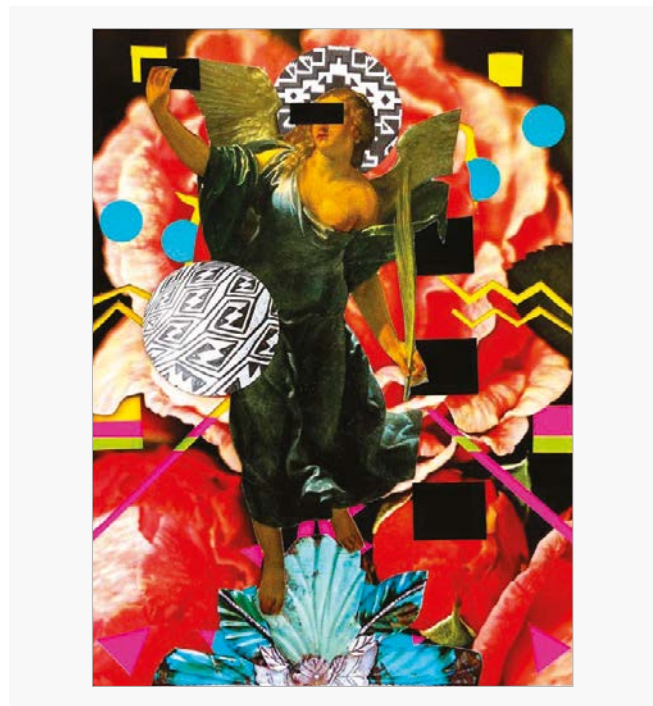

LM-007

Artist: Luis Martin

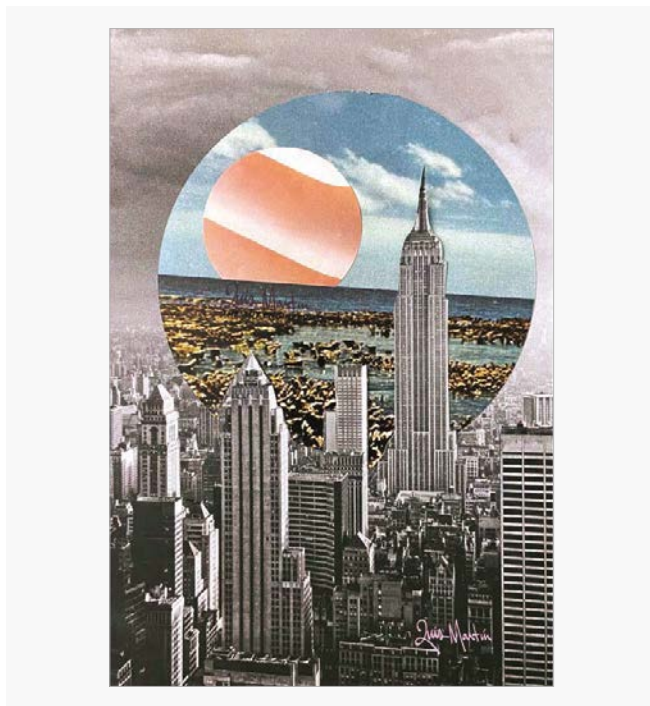

LM-008

Artist: Luis Martin

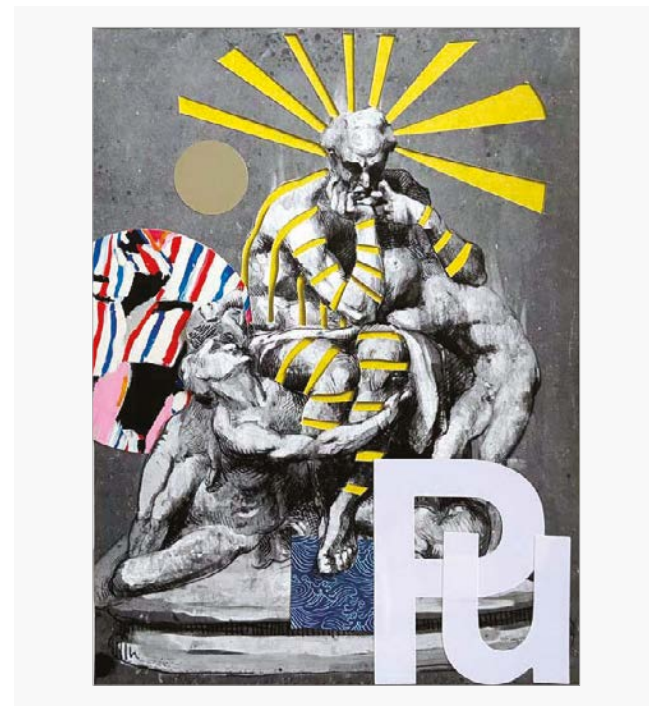

LM-011

Artist: Luis Martin



LM-012

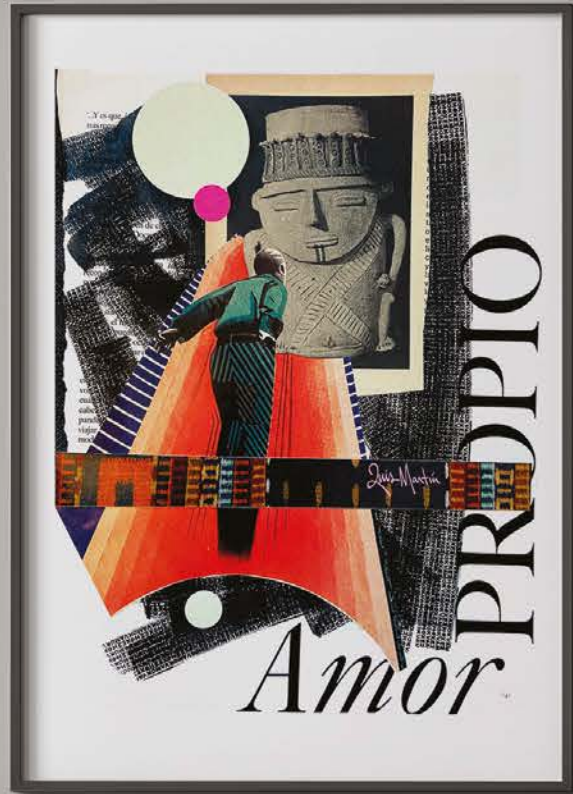

Riccardo Morvillo

Colore, street art, cura dei dettagli, ossessione per i volumi, sperimentazione. Questi gli ingredienti che compongono le illustrazioni di Riccardo. Illustratore, fotografo e videomaker, dopo anni di studio da autodidatta focalizza che la sua vera natura è la Digital Art: mette da parte pantoni e matite, e segue un percorso personale come digital artist. I suoi lavori spaziano tra illustrazione, grafica, fotografia e video.

/ Color, street art, attention to detail, obsession with volumes, experimentation. These are the ingredients that make up Riccardo's illustrations. Illustrator, photographer and videomaker, after years of self-taught study he focuses that his true nature is Digital Art: he puts aside pantones and pencils, and follows a personal path as a digital artist. His works range from illustration, graphics, photography and video.

Artist: Riccardo Morvillo

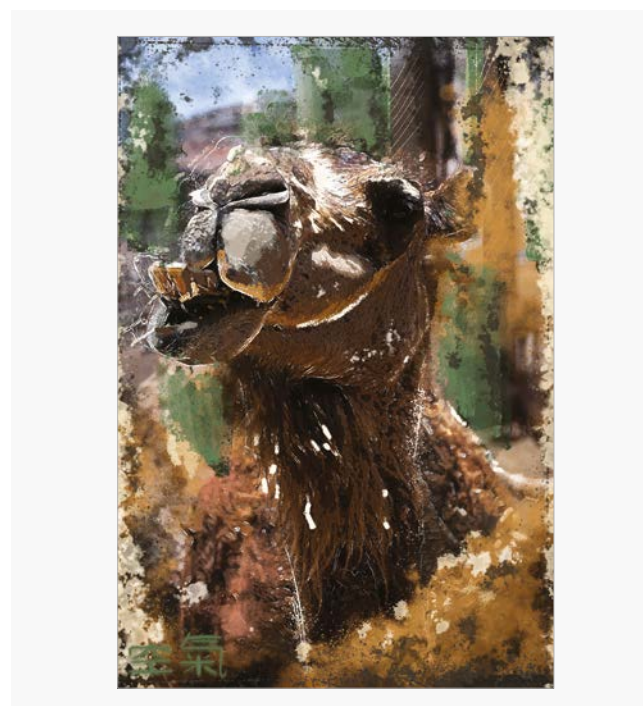

MO-001

Artist: Riccardo Morvillo

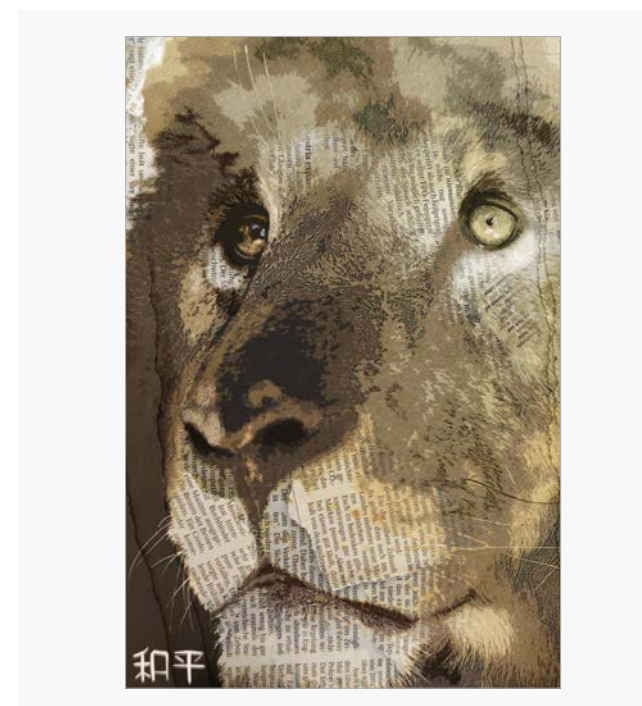

MO-002

Artist: Riccardo Morvillo



MO-003

Artist: Riccardo Morvillo

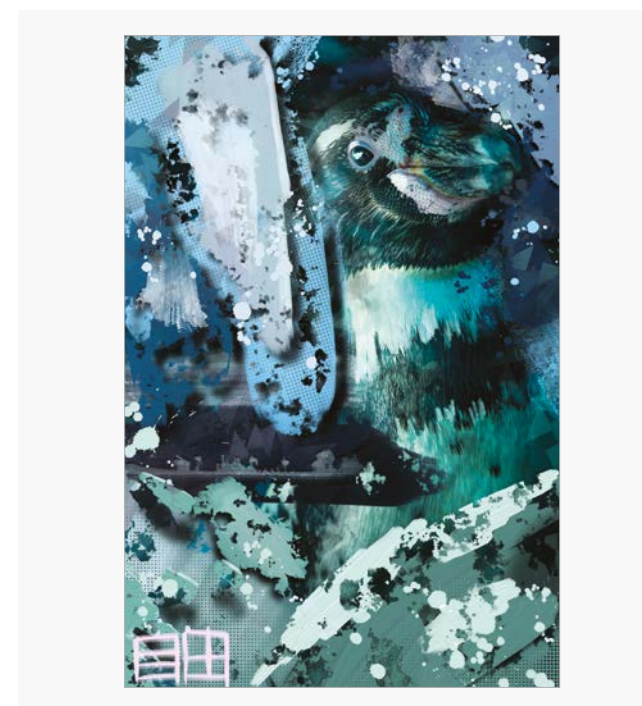

MO-004

Artist: Riccardo Morvillo

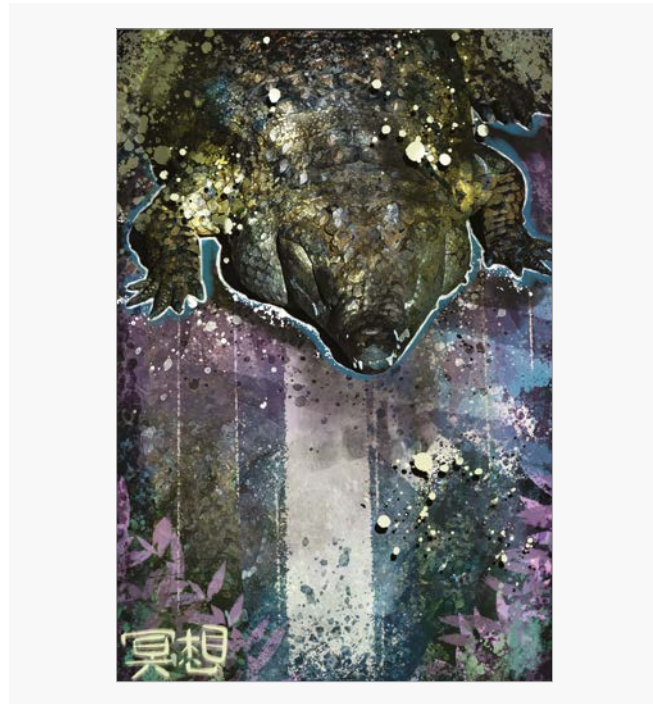

MO-005

Artist: Riccardo Morvillo

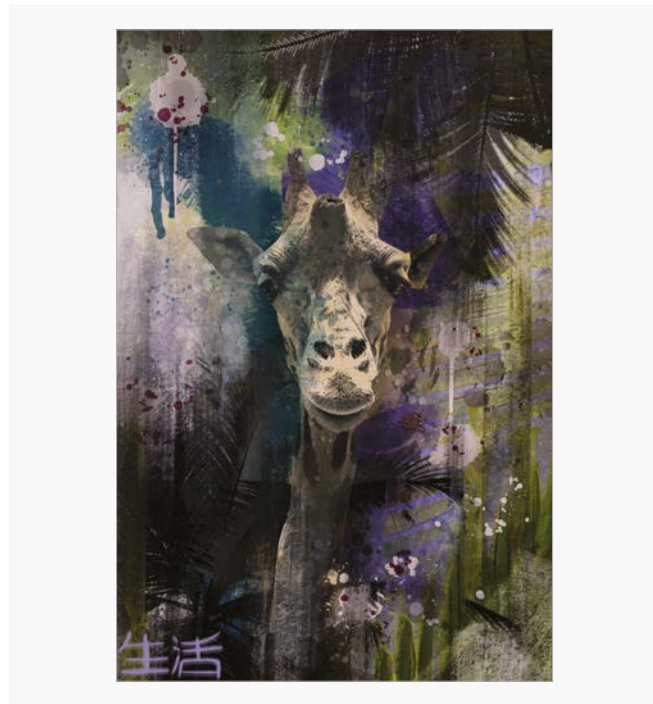

MO-007

Artist: Riccardo Morvillo

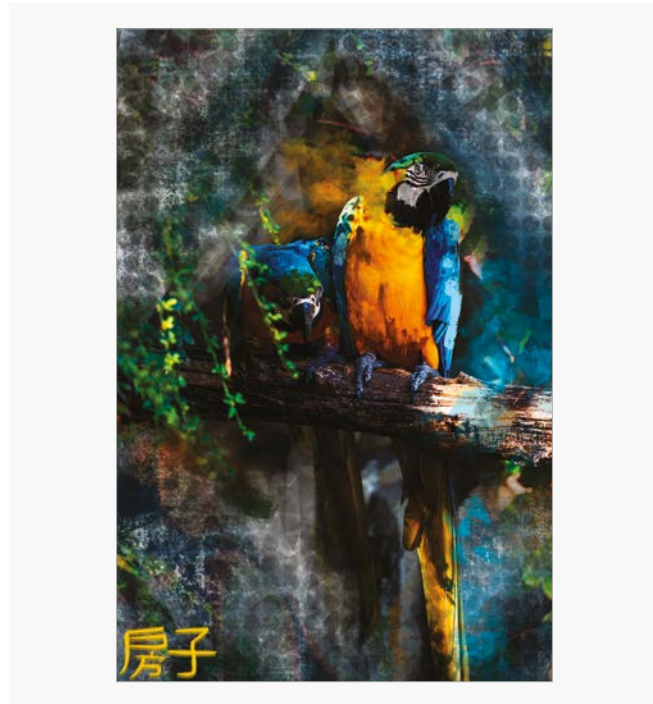

MO-006

Artist: Riccardo Morvillo

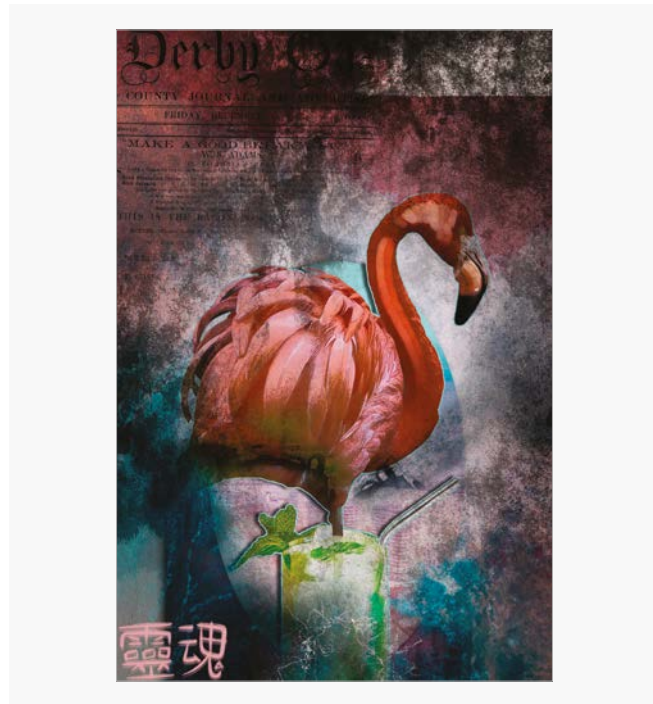

MO-008



Peeter Must

Nato nel 1967 in Estonia, si è laureato presso l'Accademia d'arte estone. Uno degli scopi principali dell'arte dovrebbe essere offrire piacere estetico, far dimenticare al pubblico i propri problemi, aiutarlo a vedere il momento successivo in una luce un po' più brillante. Per questo la sua arte è libera da problemi e tendenze: i temi espressivi del colore e le delicate figure femminili mostrano che c'è sempre una luce alla fine del tunnel. Temi cromatici espressivi e delicate figure femminili creano una simbiosi, attraverso la quale desidero dimostrare che c'è sempre una luce alla fine del tunnel. Una donna nella mia arte è come una tabella di marcia, che mi guida e mi mostra la strada in questo mondo appena aperto.

/ Born in 1967 in Estonia, he graduated from the Estonian Academy of Art. One of the main purposes of art should be to offer aesthetic pleasure, to make the public forget their problems, to help them see the next moment in a slightly brighter light. For this reason, his art is free from problems and trends: the expressive themes of color and the delicate female figures show that there is always a light at the end of the tunnel. Expressive chromatic themes and delicate female figures create a symbiosis, through which I wish to demonstrate that there is always a light at the end of the tunnel. A woman in my art is like a roadmap, guiding me and showing me the way in this newly opened world.

Artist: Peeter Must



PE-001

Artist: Peeter Must



PE-002

Artist: Peeter Must



PE-003

Artist: Peeter Must



PE-004

Artist: Peeter Must



PE-005

Artist: Peeter Must

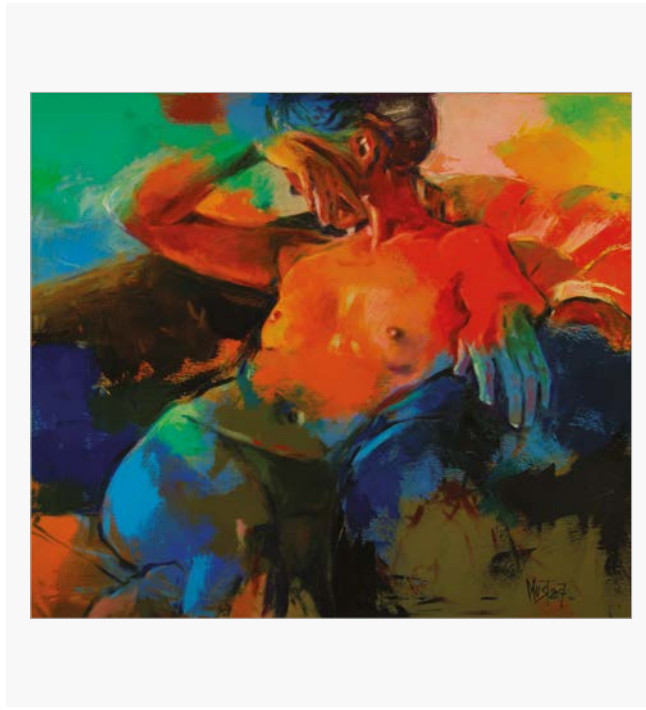

PE-006

Artist: Peeter Must

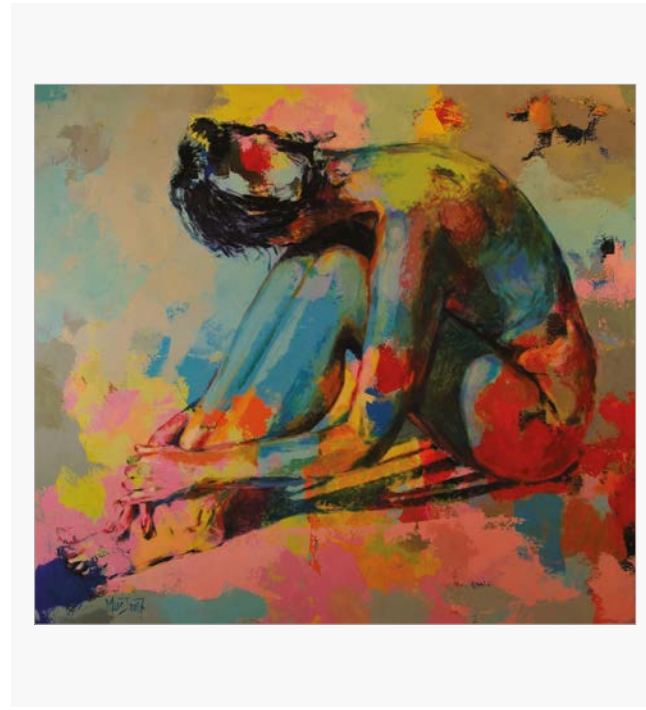

PE-010

Artist: Peeter Must



PE-011

Artist: Peeter Must

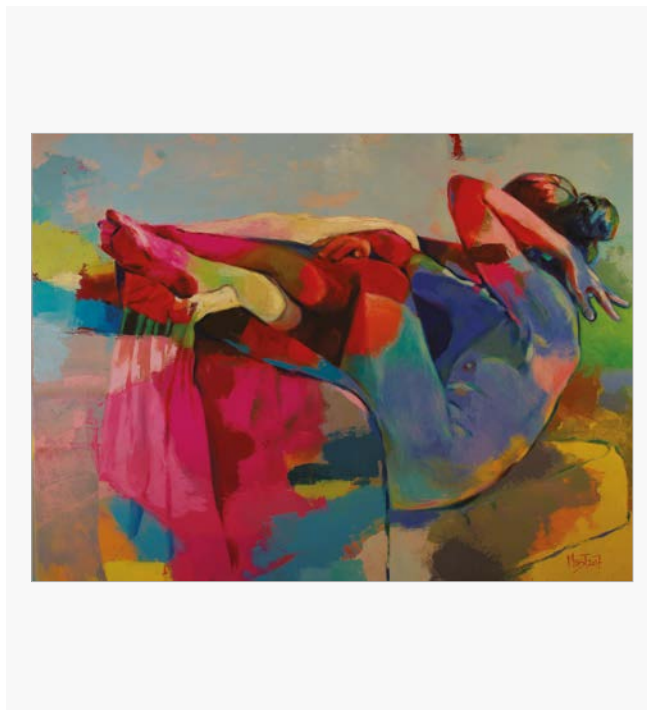

PE-007

Artist: Peeter Must



PE-009

Artist: Peeter Must

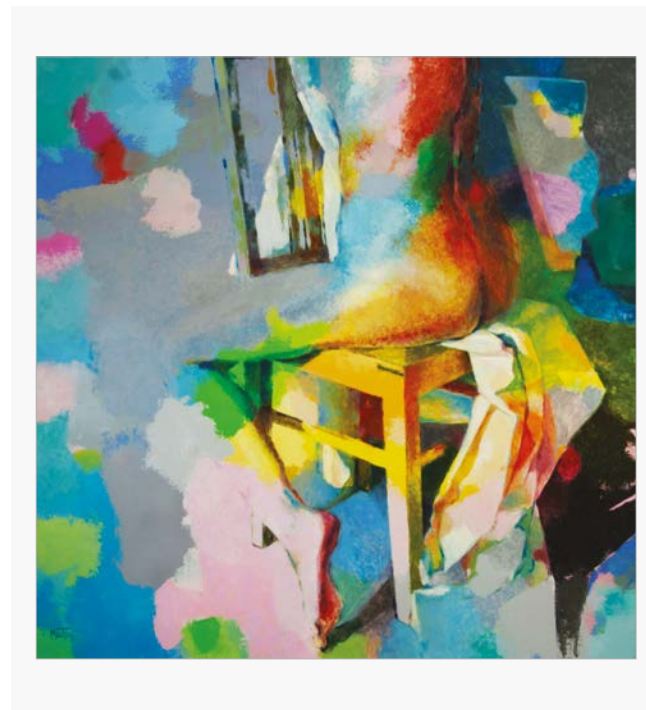

PE-012

Artist: Peeter Must

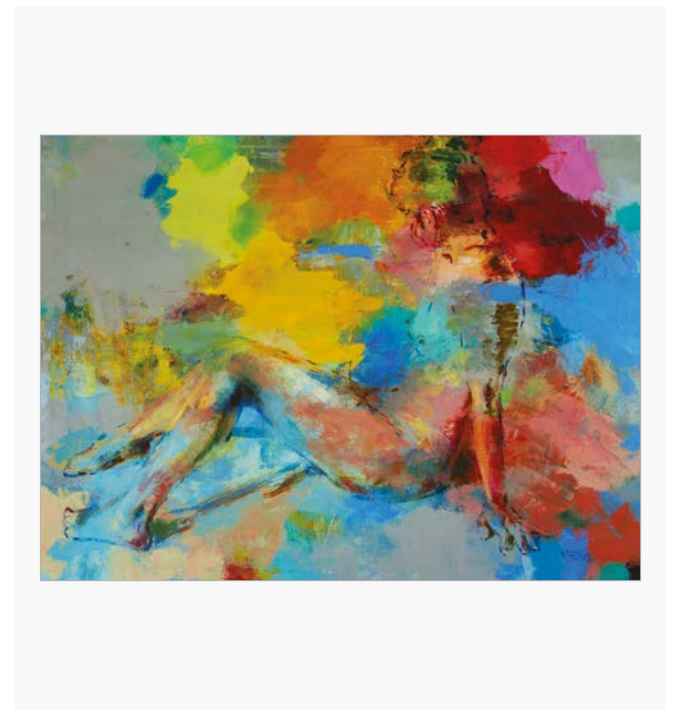

PE-013

Artist: Peeter Must



PE-014

Artist: Peeter Must



PE-015

Artist: Peeter Must



PE-016

Artist: Peeter Must

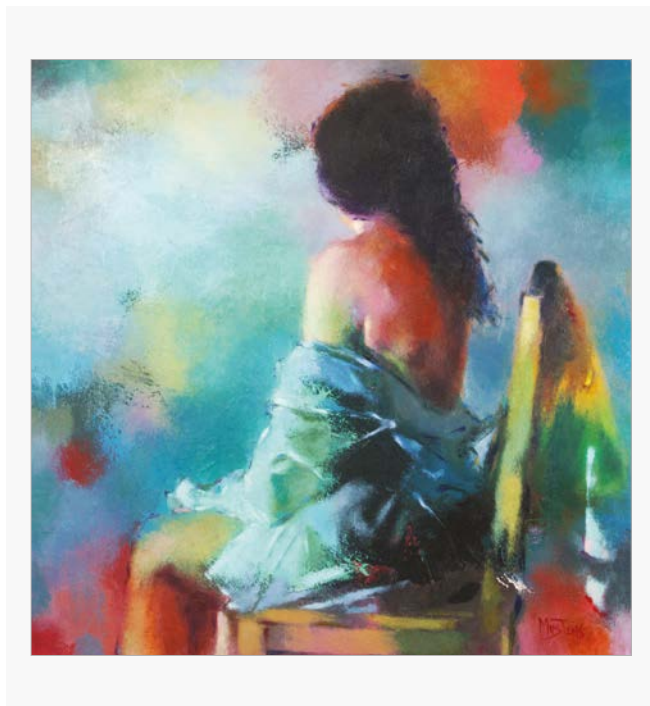

PE-017

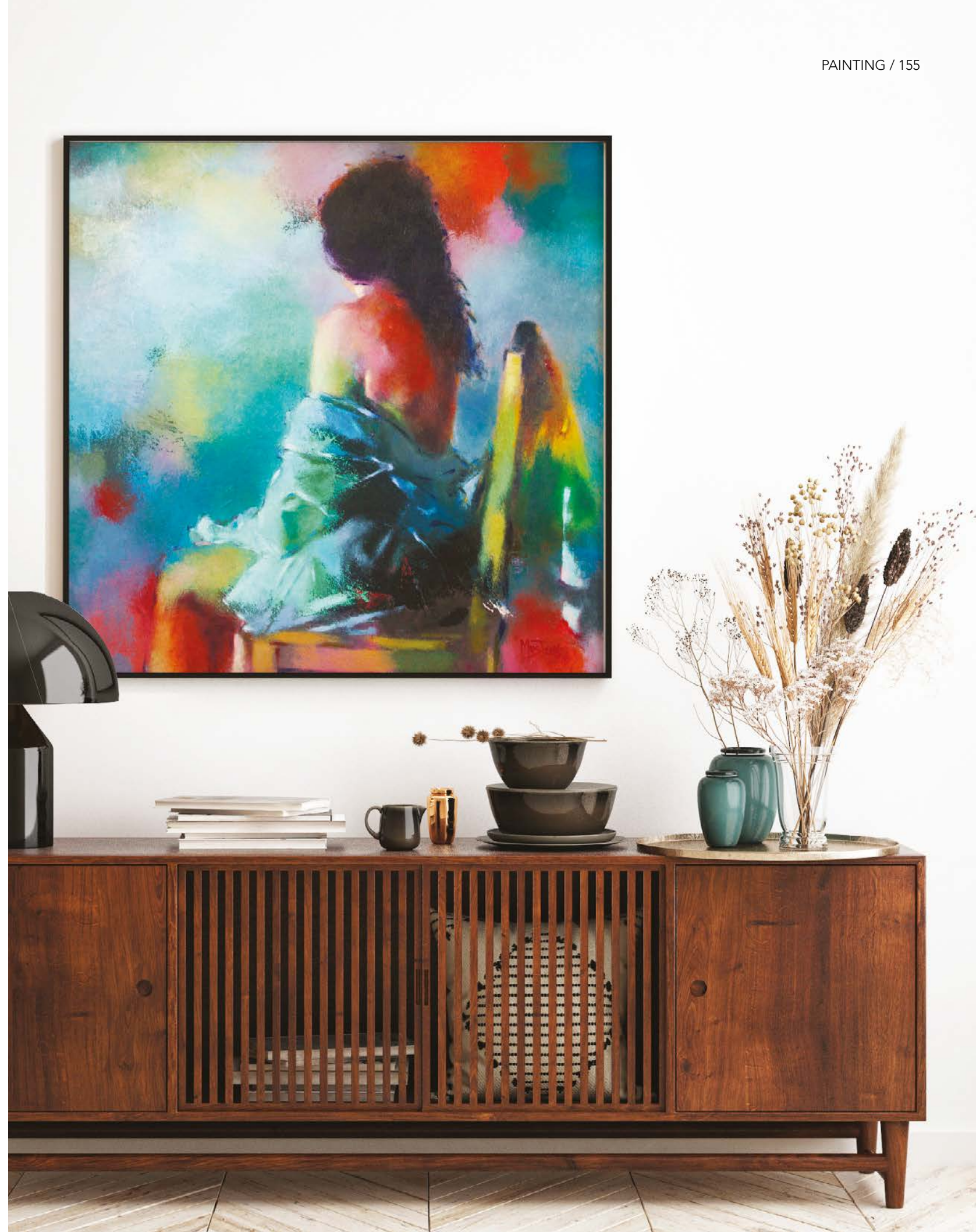

Riccardo Raul Papavero

Riccardo Raul Papavero eredita dalla madre, artista affermata, l'interesse per l'arte in tutte le sue forme. Viaggia in Europa, Africa e Sud America con la curiosità vorace di chi vuole scoprire e conoscere l'arte della diversità. Il bisogno di confrontarsi con nuove espressioni artistiche lo conduce alla realizzazione di collage polimaterici: l'inizio dell'avventura avviene a metà tra il gioco e il caso... Nel 2003 la strenua ricerca della locandina di Buffalo 66, film di nicchia di Vincent Gallo, lo porta a girovagare per negozi e sviscerare il film di Gallo per farlo rivivere su legno. Seleziona, spacca e scompone i singoli frame, rielaborandoli in un collage che fonde pittura e stampa digitale, artigianato e nuove tecnologie. Così il gioco diventa passione irrinunciabile e, con il tempo, laboratorio sperimentale. L'incessante ricerca di materiali e la continua rivoluzione di concept artistici lo portano a creare opere fortemente caratterizzate: la tecnica si raffina, i materiali si legano per armonia o contrasto e le opere sembrano costruirsi da sé. Ogni pezzo è unico e irripetibile in questo gioco alchemico della trasformazione.

/ Riccardo Raul Papavero inherits from his mother, an established artist, an interest in art in all its forms. Travel to Europe, Africa and South America with the voracious curiosity of those who want to discover and learn about the art of diversity. The need to deal with new artistic expressions leads him to the creation of multi-material collages: the beginning of the adventure takes place halfway between play and chance... In 2003 the strenuous search for the poster of Buffalo 66, Vincent's niche film Gallo takes him to wander around the shops and dissect Gallo's film to revive it on wood. It selects, splits and breaks down the individual frames, reworking them in a collage that blends painting and digital printing, craftsmanship and new technologies. Thus the game becomes an indispensable passion and, over time, an experimental laboratory. The incessant search for materials and the continuous revolution of artistic concepts lead him to create highly characterized works: the technique is refined, the materials are linked by harmony or contrast and the works seem to build themselves. Each piece is unique and unrepeatably in this alchemical game of transformation.

Artist: Riccardo Raul Papavero

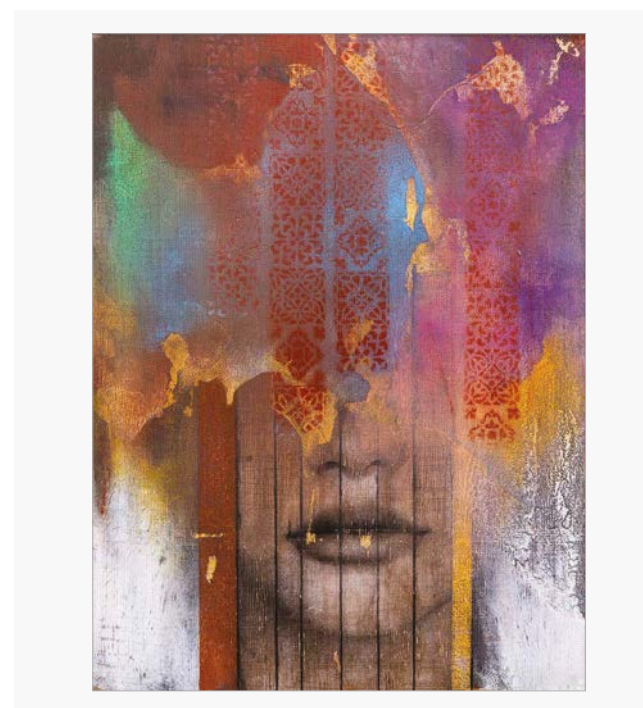

RP-001

Artist: Riccardo Raul Papavero



RP-002

Artist: Riccardo Raul Papavero

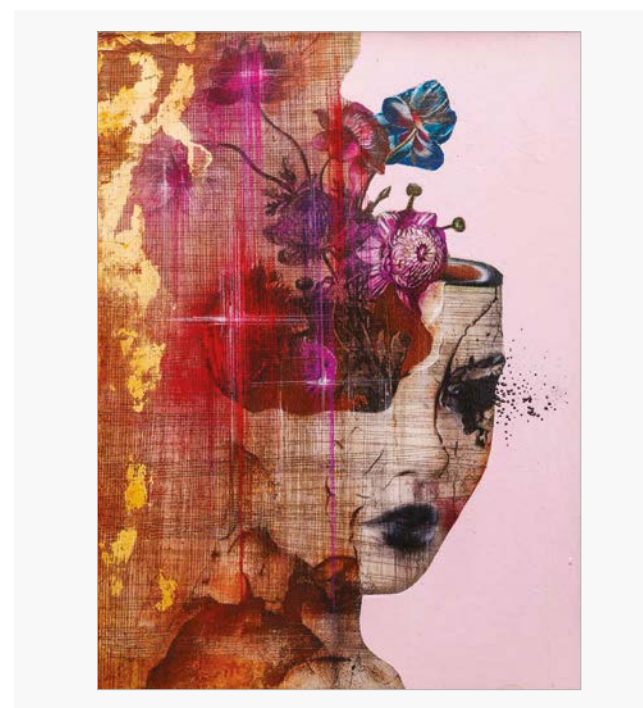

RP-003

Artist: Riccardo Raul Papavero

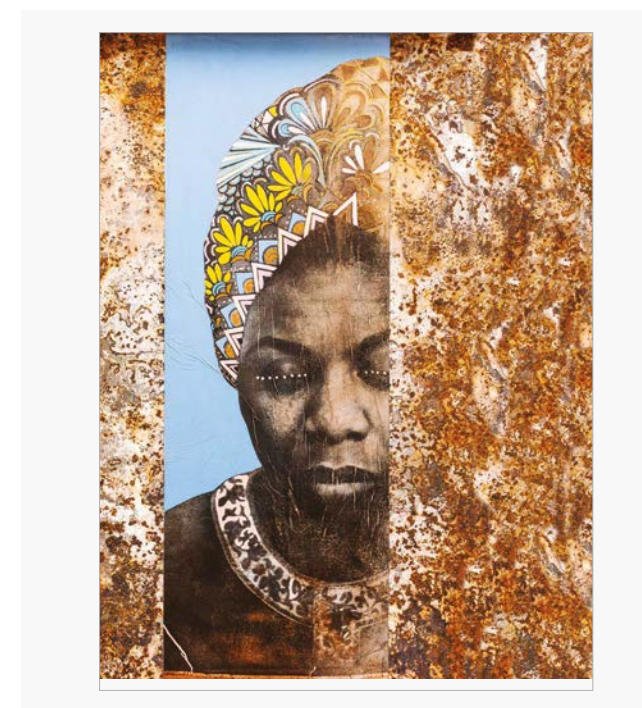

RP-004

Artist: Riccardo Raul Papavero

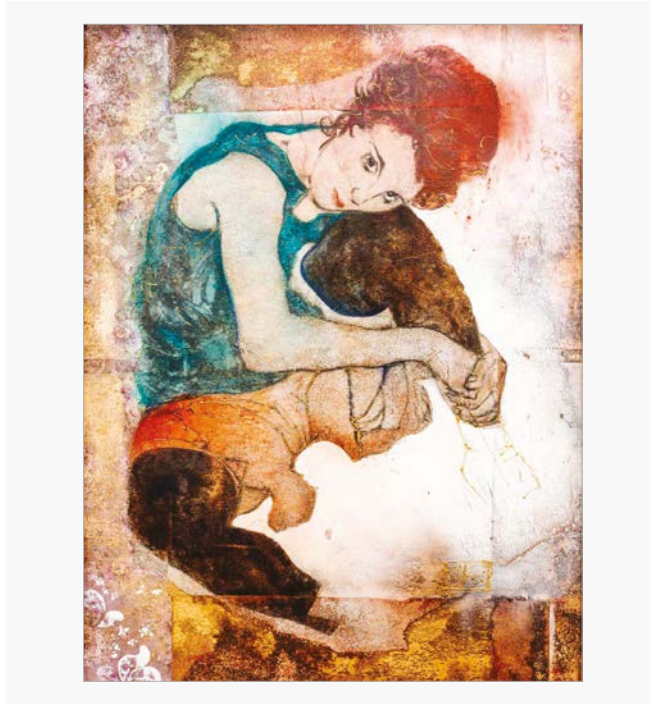

RP-005

Artist: Riccardo Raul Papavero

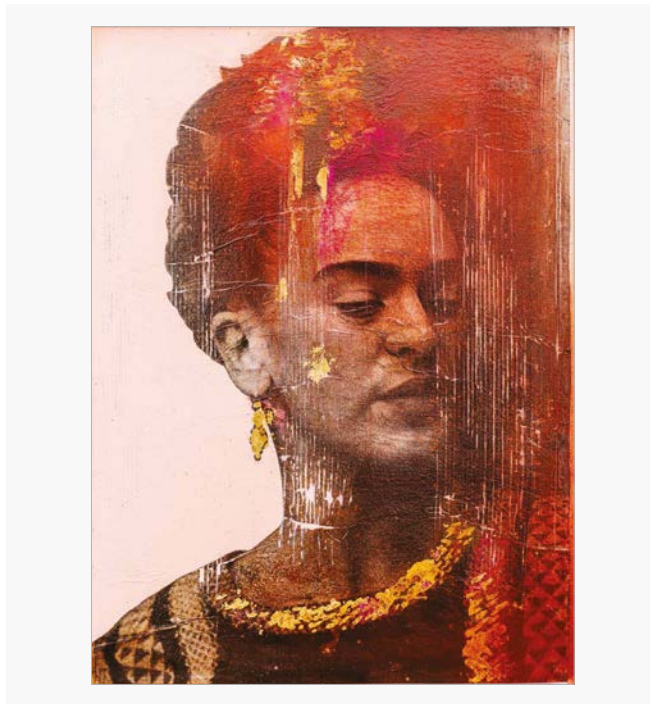

RP-007

Artist: Riccardo Raul Papavero

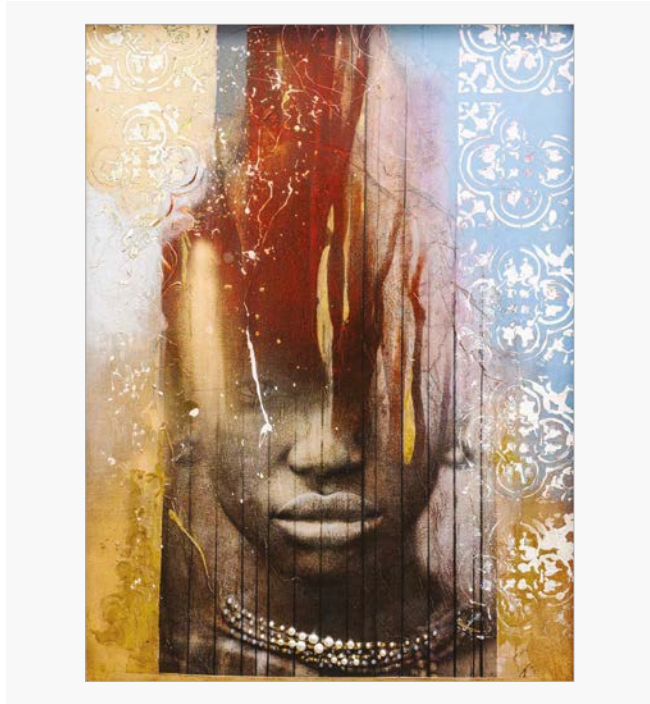

RP-006

Artist: Riccardo Raul Papavero

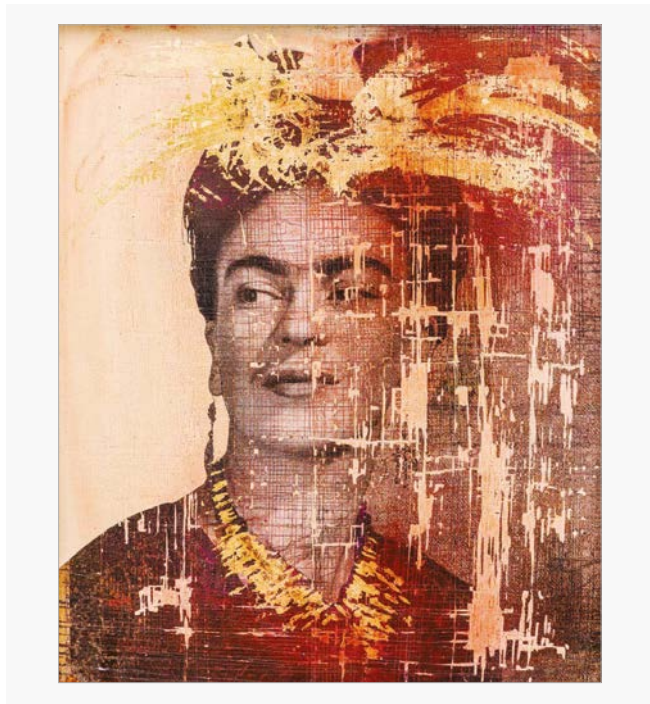

RP-008

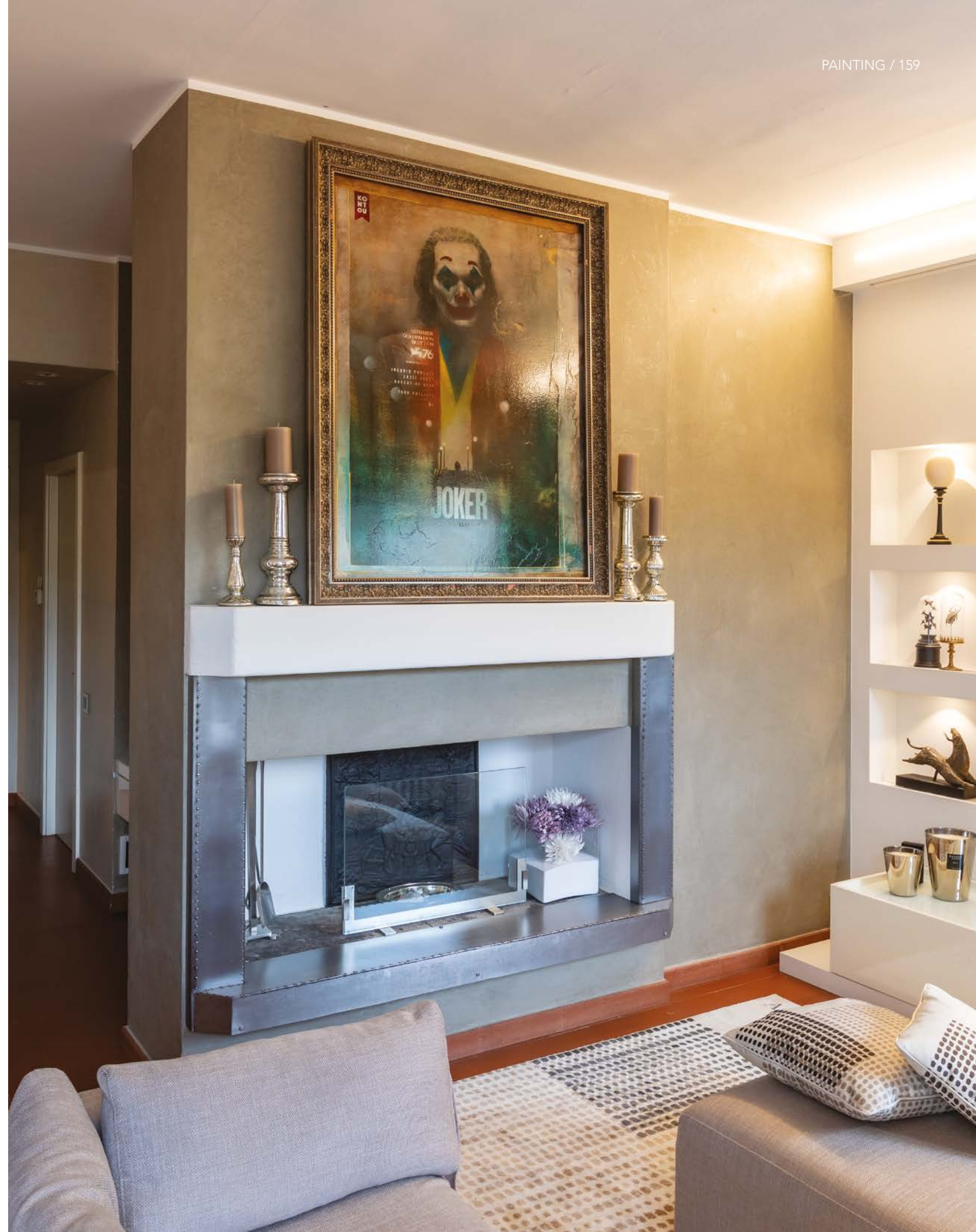

Artist: Riccardo Raul Papavero

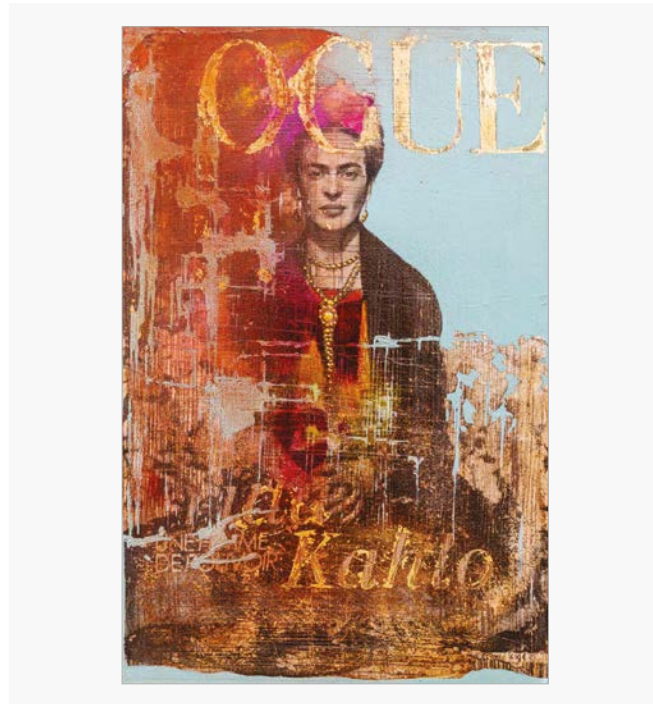

RP-009

Artist: Riccardo Raul Papavero

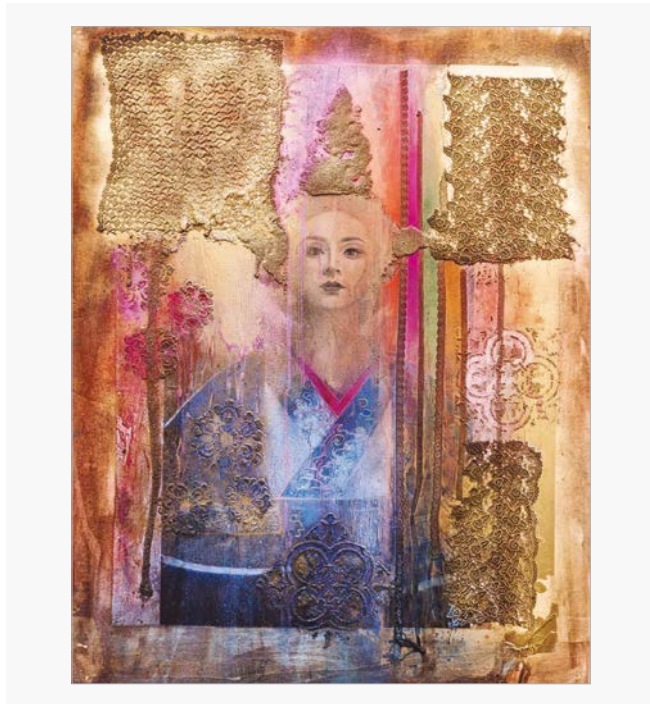

RP-010

Artist: Riccardo Raul Papavero

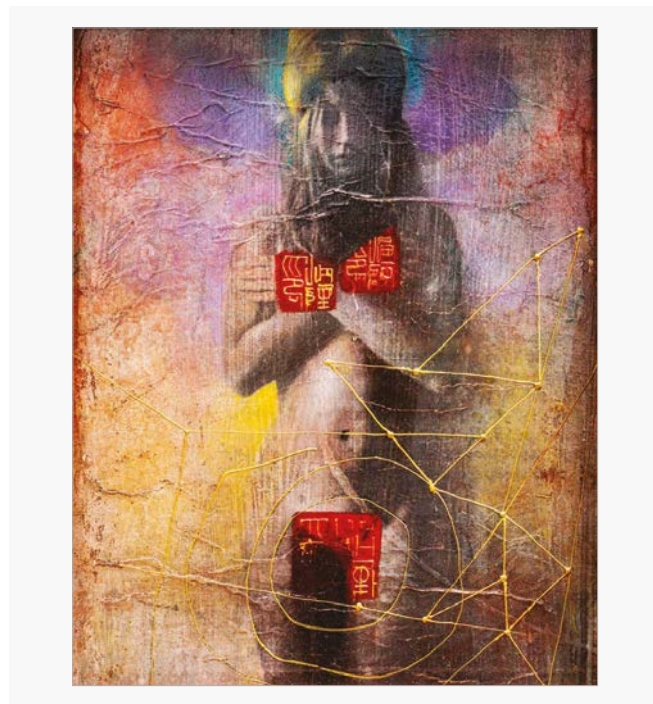

RP-011

Artist: Riccardo Raul Papavero

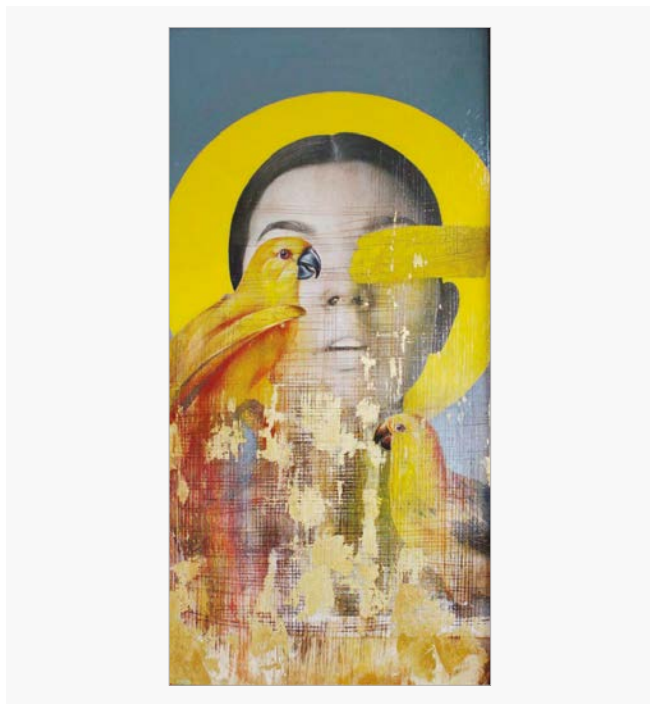

RP-012



Michele Pau

Michele Pau nasce a Oristano nel 1983, attualmente dedica la sua vita alla pittura. Nel 2014 inizia a frequentare il laboratorio-studio della pittrice italo-argentina Norma Trogu in Oristano. Fin da subito il suo interesse artistico si è manifestato nella pittura figurativa; nel corso del 2019 è cominciato un processo di trasformazione comprendente una narrazione intenzionalmente nascosta e lasciata all'interpretazione dello spettatore. Le opere includono un motivo ormai ricorrente visualizzato attraverso paesaggi espansivi e da figure isolate che mostrano il passaggio da un'interpretazione realistica ad un'altra, alterata e disgregata.

/ Michele Pau was born in Oristano in 1983, currently dedicates his life to painting. In 2014 he began attending the workshop-studio of the Italian-Argentine painter Norma Trogu in Oristano. His artistic interest immediately manifested itself in figurative painting; During 2019, a transformation process began including an intentionally hidden narrative left to the spectator's interpretation. The works include a now recurring motif displayed through expansive landscapes and isolated figures that show the transition from one realistic interpretation to another, altered and disrupted.

Artist: Michele Pau



MP-001

Artist: Michele Pau



MP-002

Artist: Michele Pau

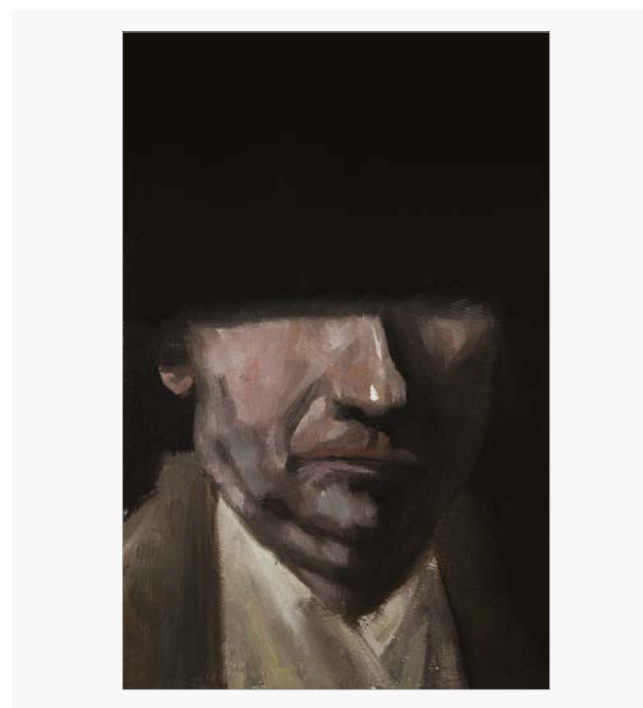

MP-003

Artist: Michele Pau

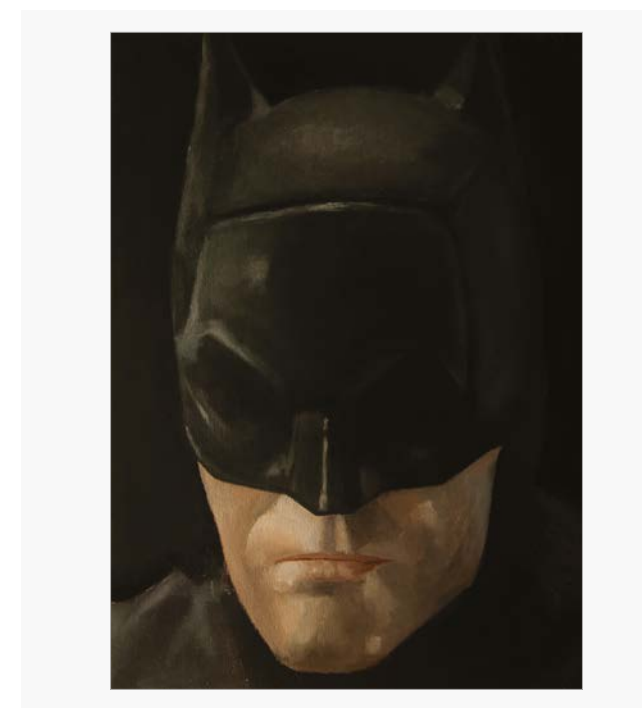

MP-004

Artist: Michele Pau



MP-005

Artist: Michele Pau

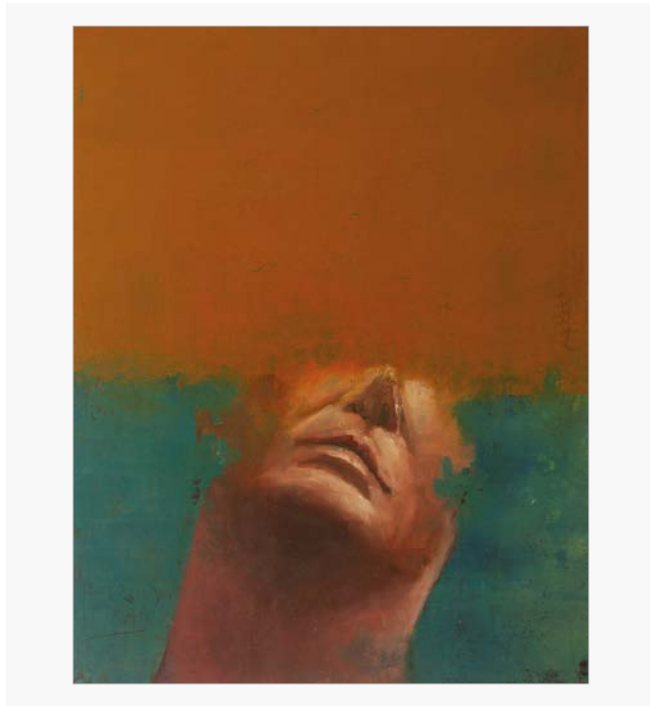

MP-006

Artist: Michele Pau

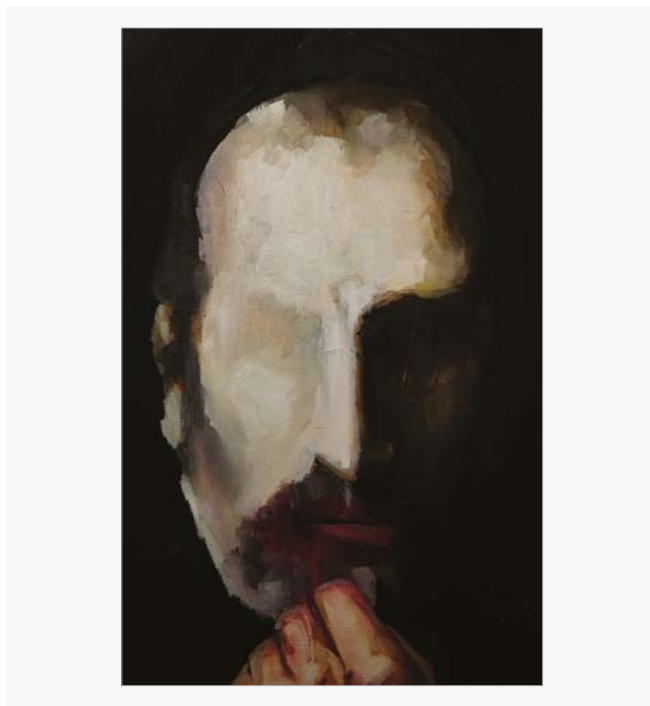

MP-007

Artist: Michele Pau



MP-008



Ludmilla Radchenko

Ludmilla Radchenko nasce l'11 novembre 1978 a Omsk in Siberia, dove si diploma in Fashion Design nel 1999. Nello stesso anno approda in Italia, dove lavora come modella, show-girl e attrice fino al 2008. Nel 2009, dopo un corso alla New York Film Academy negli USA, Ludmilla decide di dedicarsi totalmente alla sua più grande passione: la pittura. La sua arte urlata si nutre di vita reale, composizioni ricche di messaggi visivi, collage di vita quotidiana con pennellate d'ironia. Da dicembre 2010 è nelle librerie Feltrinelli il suo primo catalogo: "POWER POP" edito da Skira. Su commissione realizza opere per personaggi come il campione di moto GP Jorge Lorenzo, il campione di F1 Sebastian Vettel, il cantante Jamiroquai. La creatività di Ludmilla non si limita alla tela, ma varca ambiti come moda e design, con personalizzazione degli spazi e degli arredi; da qui nascono collaborazioni con diversi brands e una linea di foulards con stampe d'arte su materiali pregiati. Il progetto "FullART" Made in Italy, riscuote successo a livello mondiale. Nel 2018, in occasione dei primi dieci anni di carriera nel mondo dell'arte e del design, Mondadori Electa pubblicherà il primo volume ufficiale dell'artista, "From Siberia with Pop".

/ Ludmilla Radchenko was born in Omsk, Siberia on 11 November 1978, where in 1999 she graduated in Fashion Design. In the same year she moved to Italy to work as a model, show-girl and actress. In 2009 she chose to pursue her greatest passion: painting. Instinctive and vital, her art drove her toward Pop Realism. Since December 2010 her first catalogue "Power Pop" edited by Skira could be found in Feltrinelli libraries with a critic essay by Fortunato D'Amico. Ludmilla created a painting for a champion of moto GP Jorge Lorenzo, for F1 world's champion Sebastian Vettel, for the rock star Jamiroquai. Far from presenting the object again and again in an hyperbolic and obsessive way as seen in the "classic" pop tradition, Radchenko loads it with social content in open accusation to its exploitation. Radchenko doesn't limit her interest to canvas but spreads her touch to fashion and design as well. The "Siberian Soup" FullART by Ludmilla Radchenko was registered as a new brand in 2013. In 2018 Mondadori Electa will publish the artist's first official book, "From Siberia with Pop", on the occasion of Ludmilla's 10th year career anniversary.

Artist: Ludmilla Radchenko



LR-001

Artist: Ludmilla Radchenko



LR-002

Artist: Ludmilla Radchenko



LR-003

Artist: Ludmilla Radchenko



LR-004

Artist: Ludmilla Radchenko



LR-005

Artist: Ludmilla Radchenko

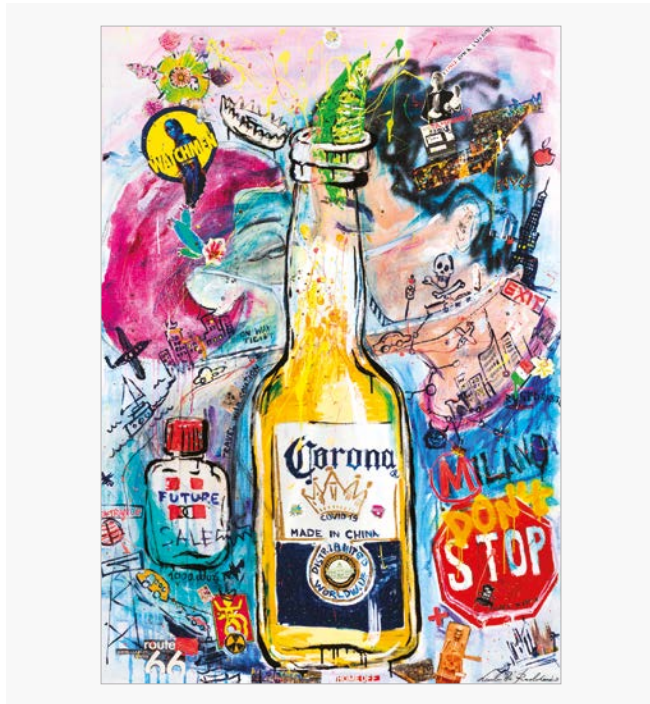

LR-006

Artist: Ludmilla Radchenko

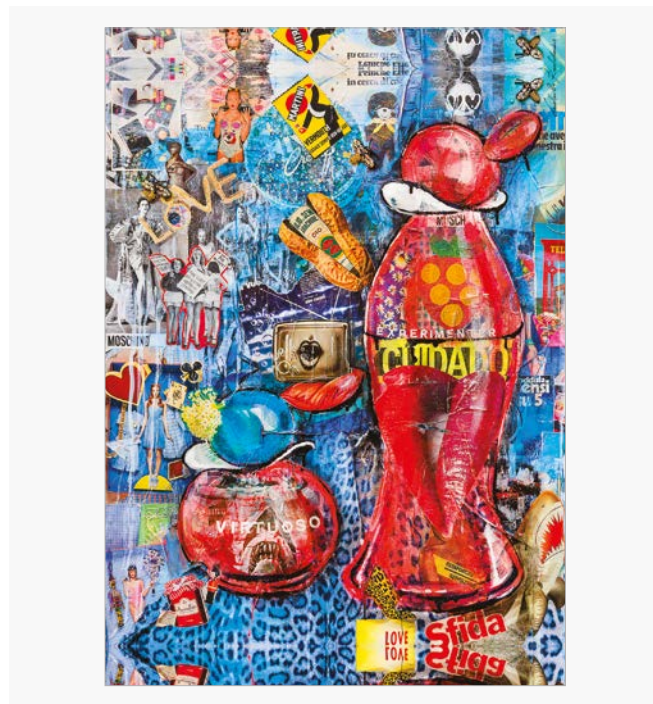

LR-007

Artist: Ludmilla Radchenko



LR-008



Artist: Ludmilla Radchenko



LR-009

Artist: Ludmilla Radchenko



LR-011

Artist: Ludmilla Radchenko



LR-010

Artist: Ludmilla Radchenko

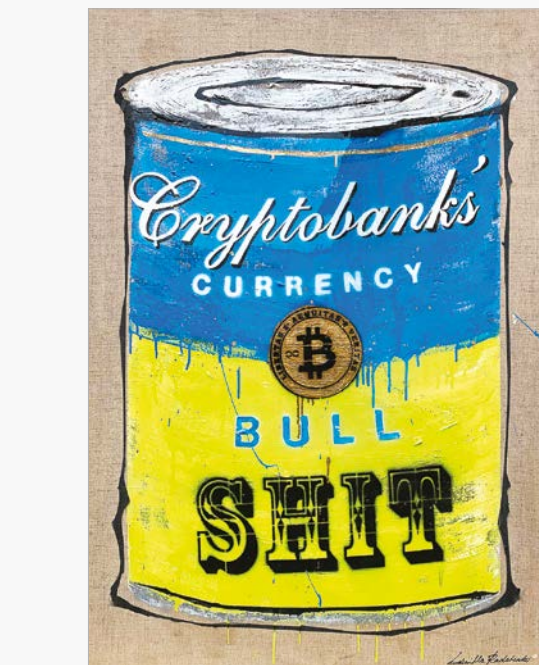

LR-012



Carlo Ravaioli

Nasce nella campagna ravennate. La sua formazione artistica spazia per un lungo periodo alla ricerca della propria dimensione tra molteplici linguaggi e discipline. Negli anni '80 apre uno studio di grafica pubblicitaria.
 "[...] Il lavoro di Carlo Ravaioli appare a chi gli si accosti originale e sorprendente, prima di tutto perché costituisce un'inedita sintesi tra due universi opposti, quasi mai conciliabili: quello delle tecnologie d'avanguardia, della computer grafica, dell'immagine elettronica, e quello dei più antichi valori materici, coloristici, disegnativi della pittura. Come un moderno alchimista, Ravaioli riesce a strutturare il suo mondo espressivo secondo questa straordinaria coincidentia oppositorum, in cui l'altissima definizione dell'immagine "immateriale" elaborata dal software sfocia nella forte presa sensuale, nella ricchezza ambigua e inquietante dei suoi dipinti [...]." (Silvia Pegoraro)

/ It was born in the Ravenna countryside. His artistic training ranges for a long period in search of his own dimension between multiple languages and disciplines. In the 1980s he opened an advertising graphics studio.
 "[...] Carlo Ravaioli's work appears original and surprising to those who approach it, first of all because it constitutes an unprecedented synthesis between two opposite universes, almost never reconcilable: that of avant-garde technologies, computer graphics, electronic image, and that of the most ancient material, coloristic and drawing values of painting. Like a modern alchemist, Ravaioli manages to structure his expressive world according to this extraordinary coincidentia oppositorum, in which the very high definition of the "immaterial" image elaborated by the software results in the strong sensual hold, in the ambiguous and disturbing richness of his paintings [...]." (Silvia Pegoraro)

Artist: Carlo Ravaioli



CR-001

Artist: Carlo Ravaioli

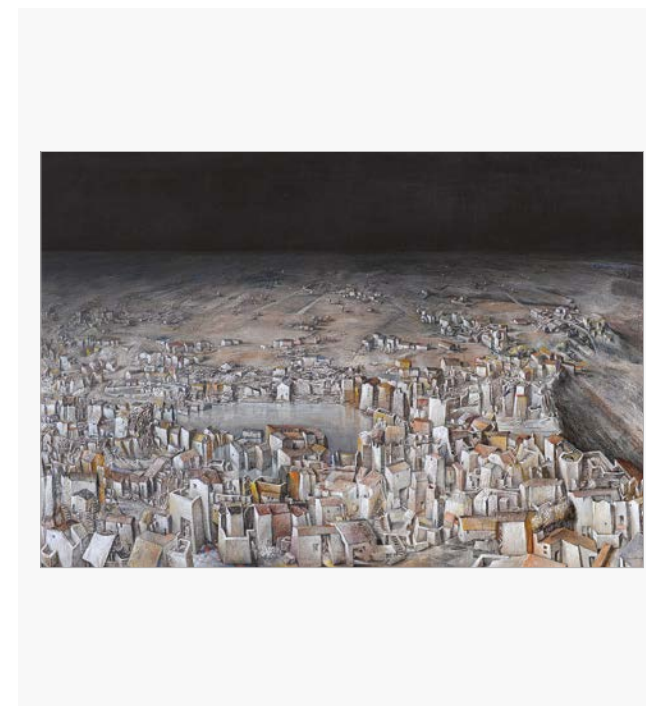

CR-002

Artist: Carlo Ravaioli



CR-003

Artist: Carlo Ravaioli

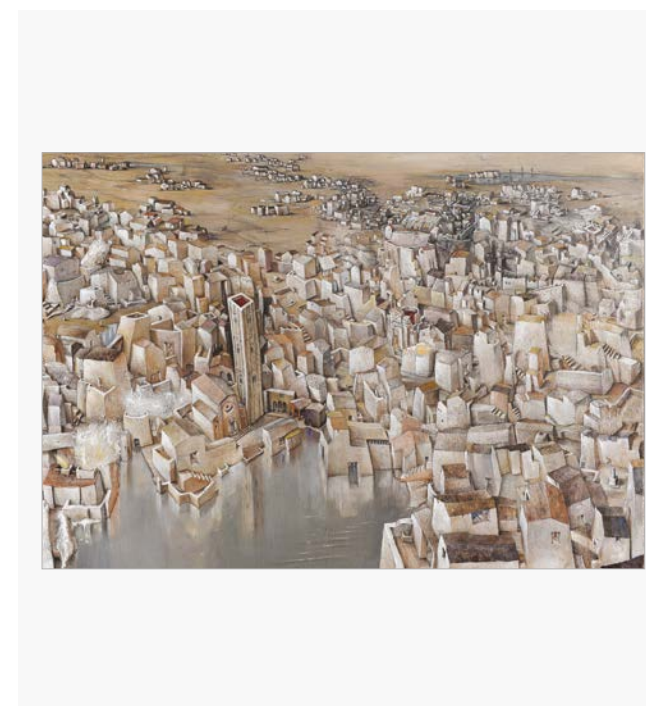

CR-004

Artist: Carlo Ravaoli

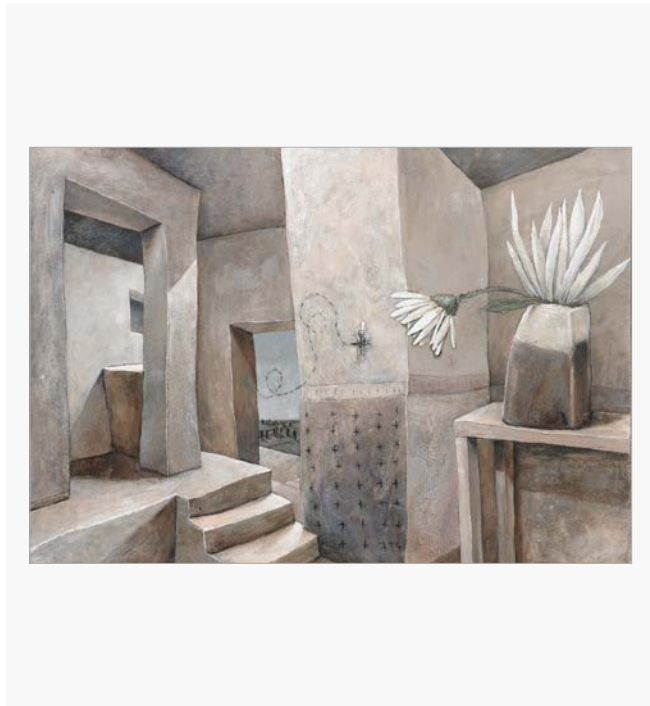

CR-005

Artist: Carlo Ravaoli



CR-006

Artist: Carlo Ravaoli



CR-007

Artist: Carlo Ravaoli

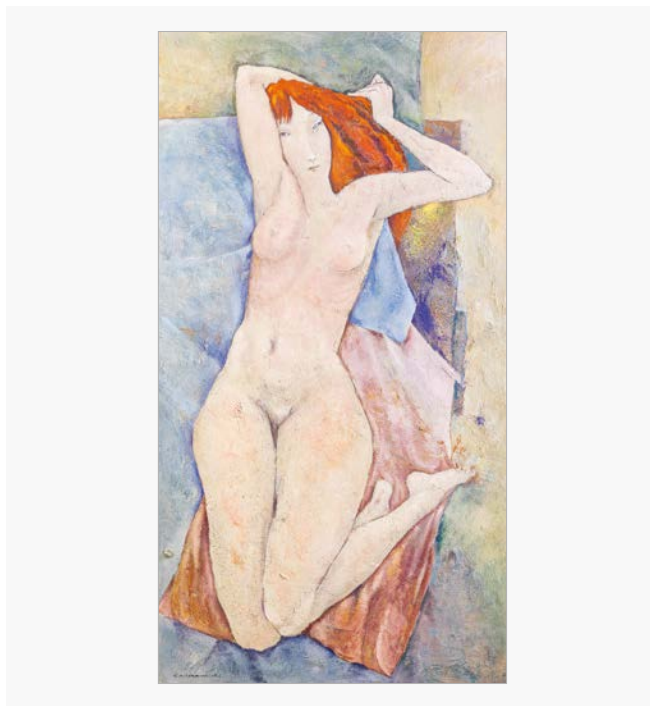

CR-008



Reve+

L'artista deve il suo nome al francese "rêver", sognare, ma letto all'italiana. Un modo per dare uno sfondo onirico alle sue creature urbane. Il suo simbolo, un +, vuole invece essere un richiamo alla positività, vero motore del suo lavoro. «Il motivo della mia azione è molto semplice, fin troppo. Io amo da sempre disegnare e credo che i miei disegni siano capaci di mettere di buon umore: sono semplici, colorati, immediati. Mi piace sapere che qualcuno uscendo di casa, guidando lungo la tangenziale, aspettando il tram possa sorriderne, anche solo per un secondo». È un mondo onirico, popolato da placidi, enormi animali. Animali rubati ad un immaginario fanciullesco che spuntano, sempre più frequentemente, su muri in cemento, casotti, infrastrutture. Reve fa parte di quella nutrita schiera di artisti suburbani che, stanchi di gallerie d'arte, compromessi, quotazioni ha deciso di donare la propria arte, la propria immaginazione alla collettività.

/ The artist owes his name to the French "rêver", to dream, but read in Italian. A way to give a dreamlike backdrop to his urban creatures. His symbol, a +, instead wants to be a call to positivity, the real engine of his work. "The reason for my action is very simple, far too simple. I have always loved drawing and I believe that my drawings are capable of putting you in a good mood: they are simple, colorful, immediate. I like to know that someone leaving the house, driving along the ring road, waiting for the tram can smile at it, if only for a second". It is a dream world, populated by placid, huge animals. Animals stolen from a childish imagination that appear more and more frequently on concrete walls, sheds, infrastructures. Reve is part of that large group of suburban artists who, tired of art galleries, compromises, quotations, decided to donate their art, their imagination to the community.

Artist: Reve+

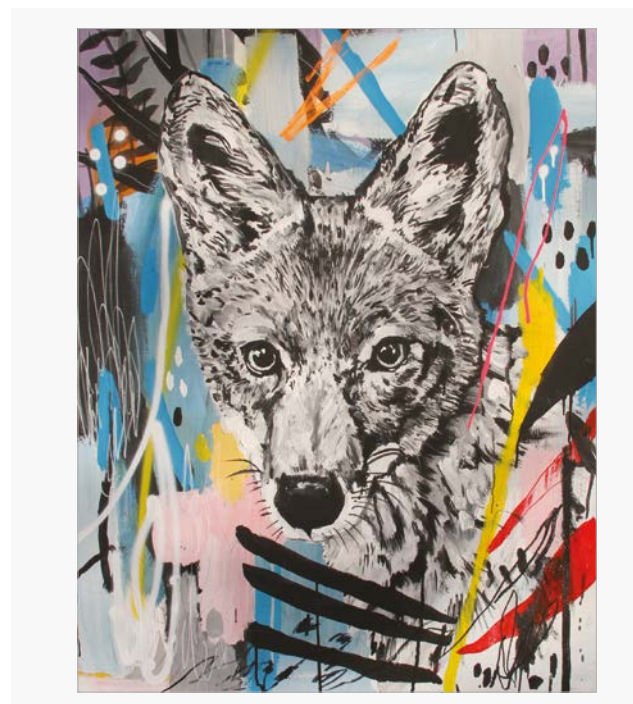

RE-005

Artist: Reve+

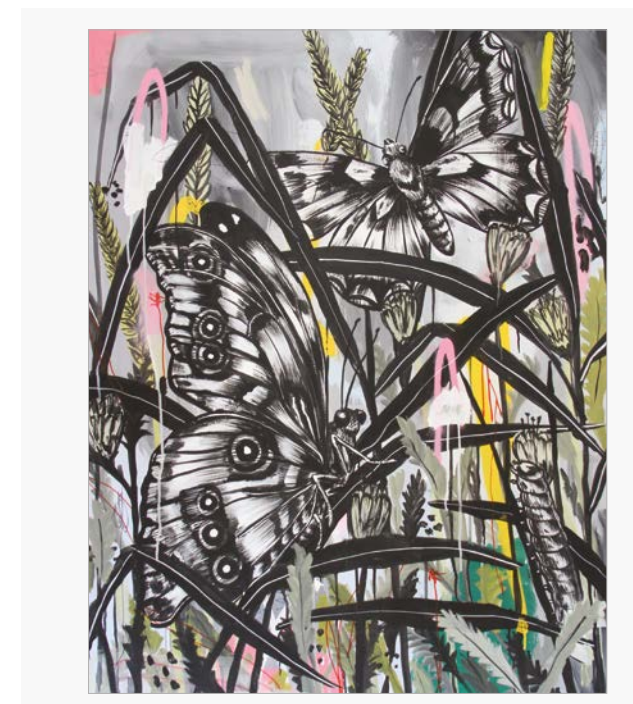

RE-006

Artist: Reve+



RE-007

Artist: Reve+

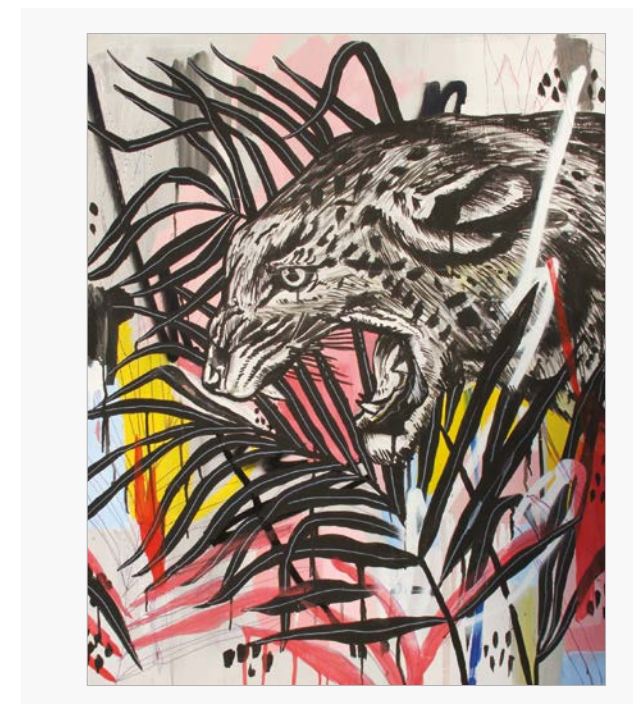

RE-008

Artist: Reve+

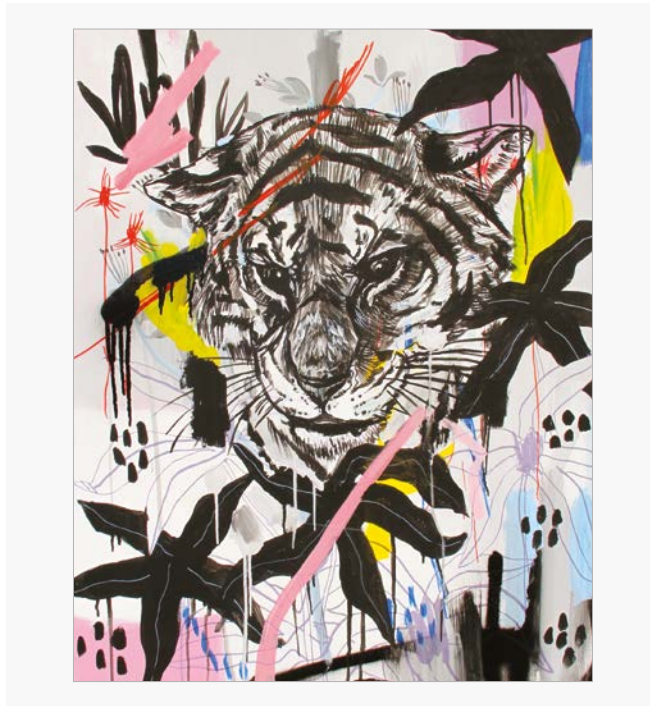

RE-009

Artist: Reve+



RE-010

Artist: Reve+

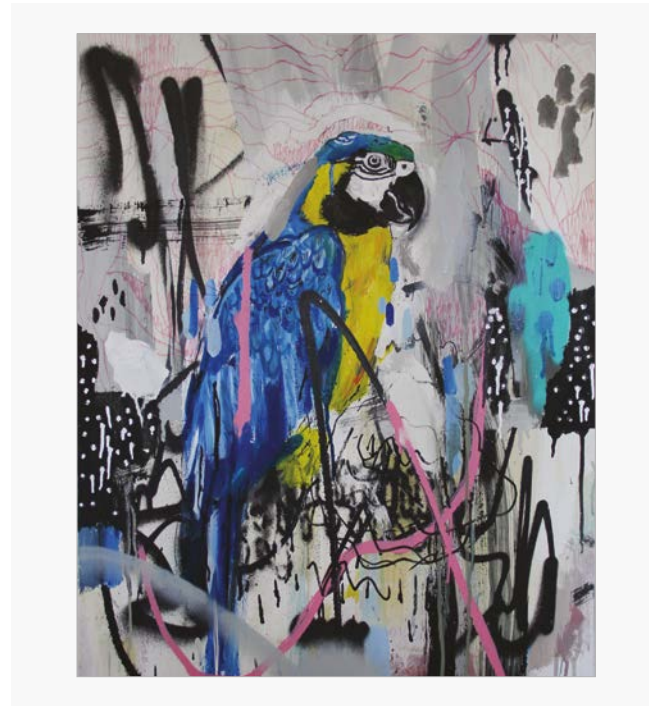

RE-013

Artist: Reve+



RE-014

Artist: Reve+



RE-011

Artist: Reve+

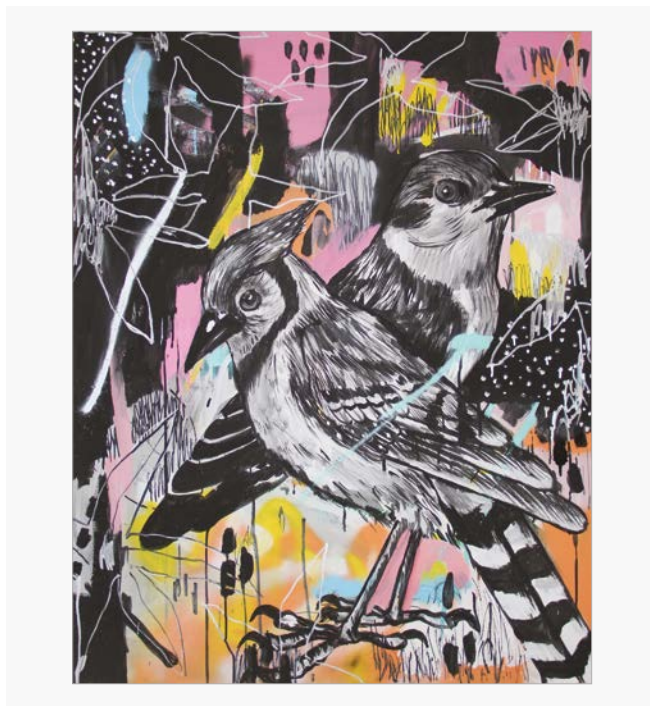

RE-012

Artist: Reve+

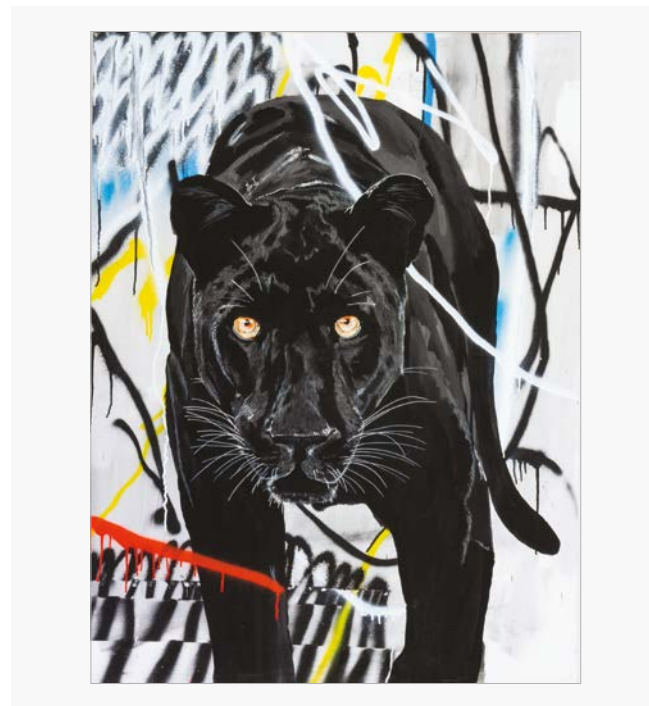

RE-015

Artist: Reve+



RE-016

Artist: Reve+



RE-017

Artist: Reve+

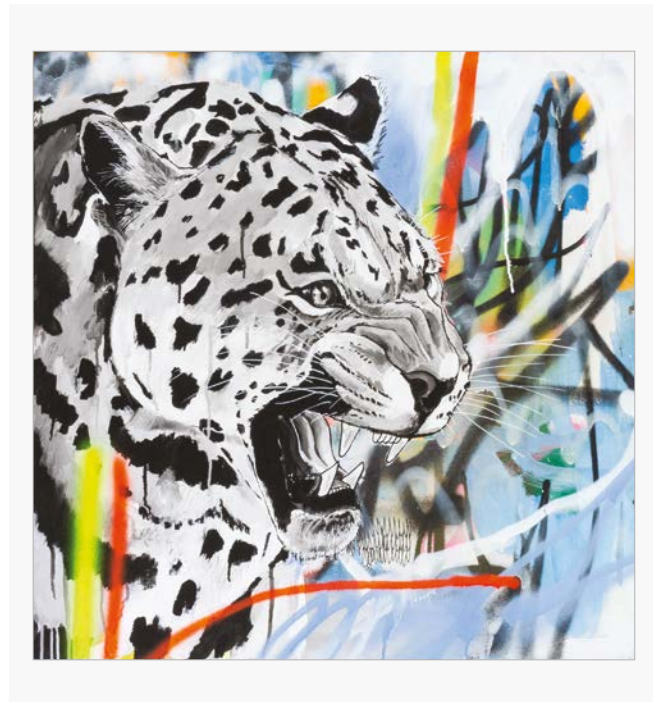

RE-019

Artist: Reve+



RE-018

Artist: Reve+

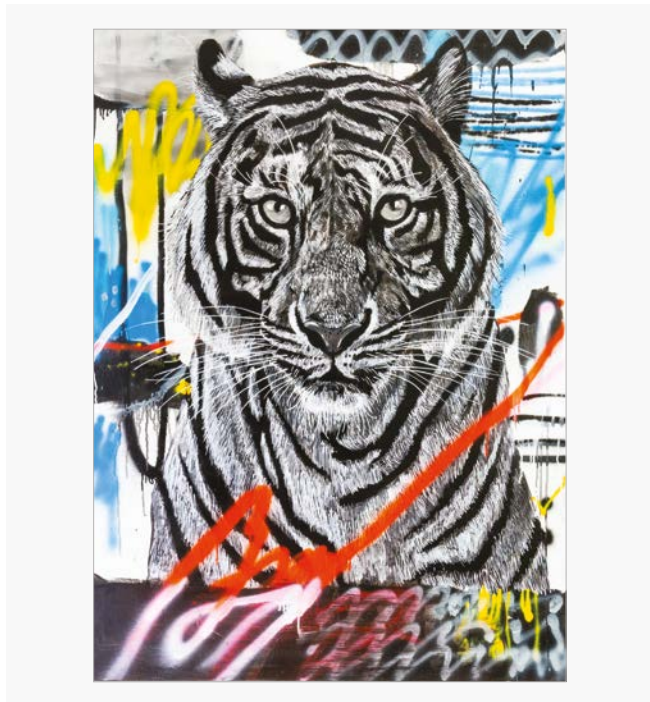

RE-020

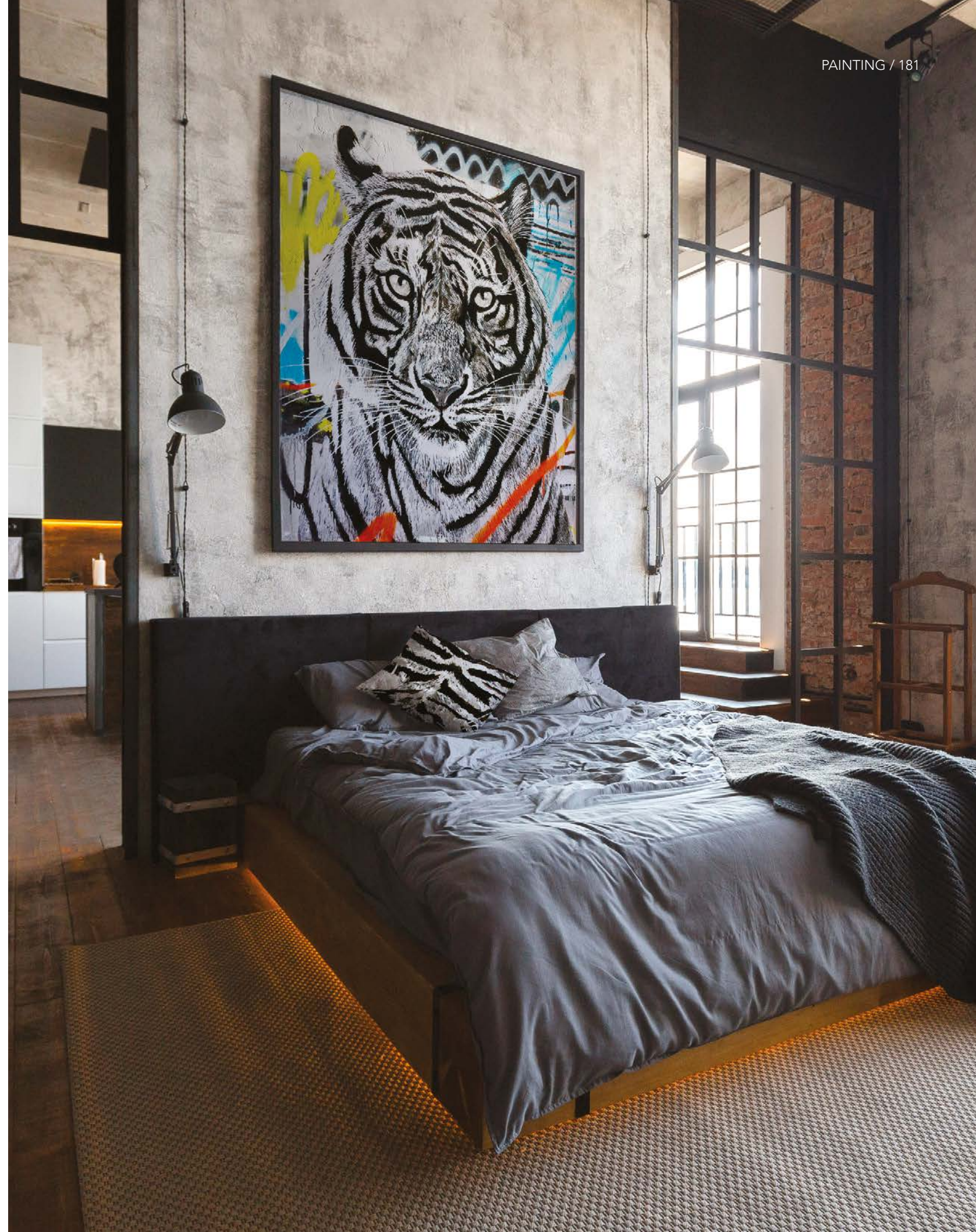

Mr. SADOS

Andrii Sadilov studia fashion design alla National University of Culture and Arts di Kiev. Usa strumenti come: olio, tela, krita e Art Rage. Dal 2005 al 2016 ha lavorato per Karara, occupandosi di marmo, e realizzando sculture e camini intagliati. Dal 2017 ad oggi lavora in Momenti come designer. Dal 2006 al 2009 ha studiato alla Kyiv National University of Culture and Arts, fashion design. Nel 2020 ha preso parte al progetto collettivo "Imunity" presso il Museo d'Arte Contemporanea ucraino di Korsaks.

/ Andrii Sadilov studies fashion design at the National University of Culture and Arts in Kiev. Use tools such as: oil, canvas, krita and Art Rage. From 2005 to 2016 he worked for Karara, dealing with marble, and making sculptures and carved fireplaces. From 2017 to today he works in Momenti as a designer. From 2006 to 2009 he studied fashion design at the Kyiv National University of Culture and Arts. In 2020 he took part in the collective project "Imunity" at the Ukrainian Museum of Contemporary Art in Korsaks.

Artist: Mr. SADOS



SD-002

Artist: Mr. SADOS



SD-003

Artist: Mr. SADOS



SD-004

Artist: Mr. SADOS



SD-005

Artist: Mr. SADOS

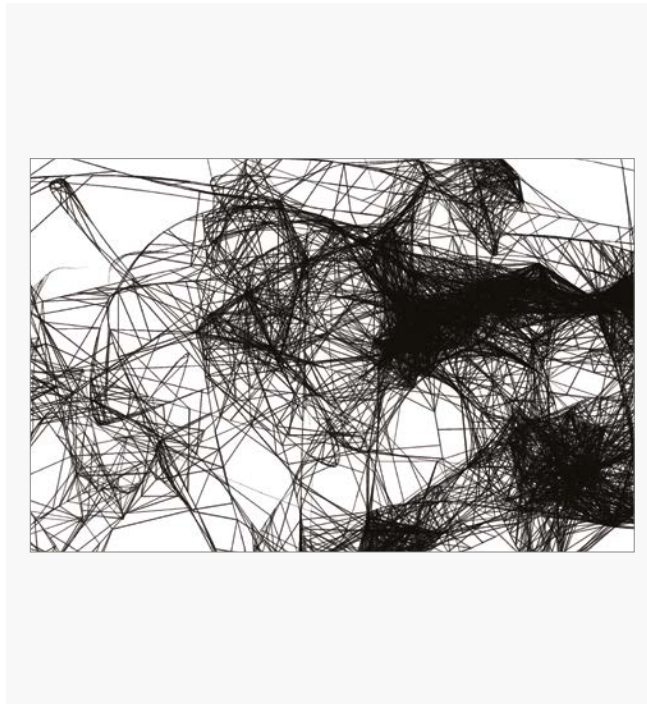

SD-007

Artist: Mr. SADOS

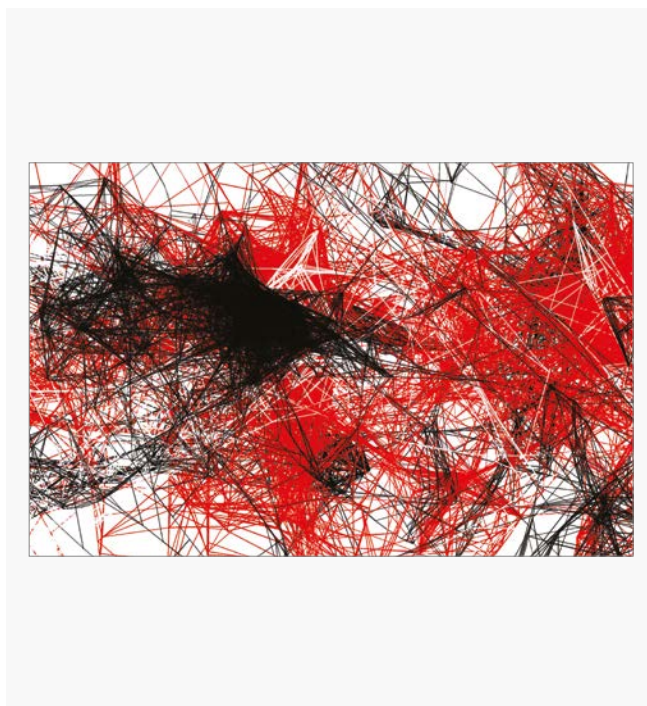

SD-009

Artist: Mr. SADOS

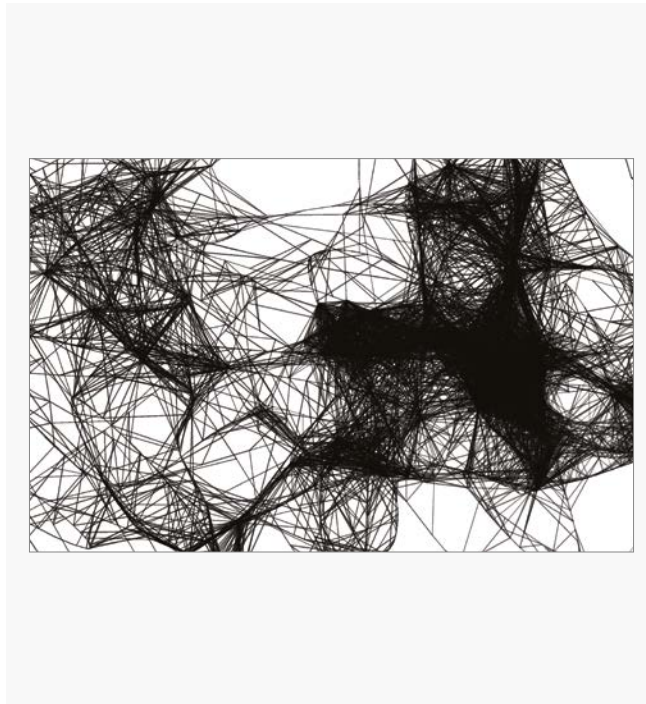

SD-008

Artist: Mr. SADOS



SD-010



SNYDER

L'artista dietro lo pseudonimo "SNYDER" occupa una posizione unica nel mondo dell'arte. I suoi molti anni di lavoro come architetto e la sua passione per la scrittura di stile sono le principali forze trainanti dietro la concettualizzazione di una nuova estetica. Li traduce in motivi che si distinguono per la loro oscillazione tra maestosa armonia e potere cangiante. I suoi motivi mostrano spesso la fragile bellezza delle specie animali in via di estinzione, che conferiscono alla sua arte un momento auratico. SNYDER spiega l'animale come una controparte piena di sentimento strato dopo strato su diversi supporti come carta, tela o superfici murali con la bomboletta spray. Le sfocature create alle frange di colore dei diversi strati conferiscono alla profondità mancante del nostro spazio dell'immagine digitale un momento di autentica natura selvaggia. Allo stesso tempo, in ciascuna delle sue opere SNYDER imita le aberrazioni cromatiche, le cosiddette aberrazioni cromatiche, che hanno trovato la loro strada nel nostro canone visivo tramite processi di imaging analogico e digitale. Le opere di SNYDER ci incoraggiano a reimparare il comportamento percettivo istintivo. Per essere visti, i mondi animali di SNYDER adattano il loro aspetto alla giungla urbana e prendono di mira con attenzione ogni spettatore di passaggio. Sviluppano un effetto trainante a cui è difficile sfuggire come passante.

/ The artist behind the pseudonym "SNYDER" occupies a unique position in the art world. His many years of work as an architect and his passion for style writing are the main driving forces behind the conceptualization of a new aesthetic. He translates these into motifs that stand out for their oscillation between majestic harmony and iridescent power. His motifs often show the fragile beauty of endangered animal species, which lend his art an auratic moment. SNYDER unfolds the animal as a soulful counterpart layer by layer on different media such as paper, canvas or wall surfaces with the spray can. The blurs created at the color fringes of the different layers give the missing depth of our digital image space a moment of authentic wildness. At the same time, in each of his works SNYDER imitates color aberrations, so-called chromatic aberrations, which have found their way into our visual canon via analog and digital imaging processes. SNYDER's works encourage us to relearn instinctive perceptual behavior. In order to be seen, SNYDER's animal worlds adapt their appearance to the urban jungle and attentively target every passing viewer. They develop a pulling effect that is difficult to escape as a passer-by.

Artist: SNYDER

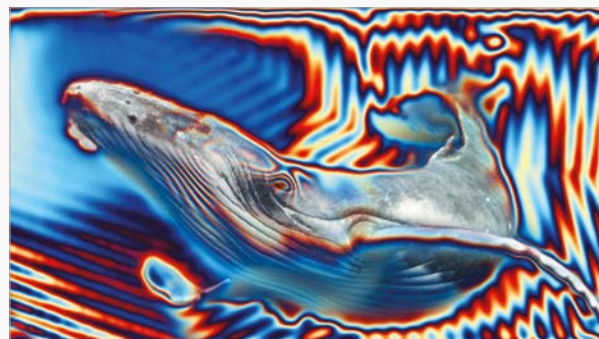

SN-001

Artist: SNYDER



SN-002

Artist: SNYDER



SN-003

Artist: SNYDER



SN-004

Artist: SNYDER



SN-005

Artist: SNYDER



SN-007

Artist: SNYDER

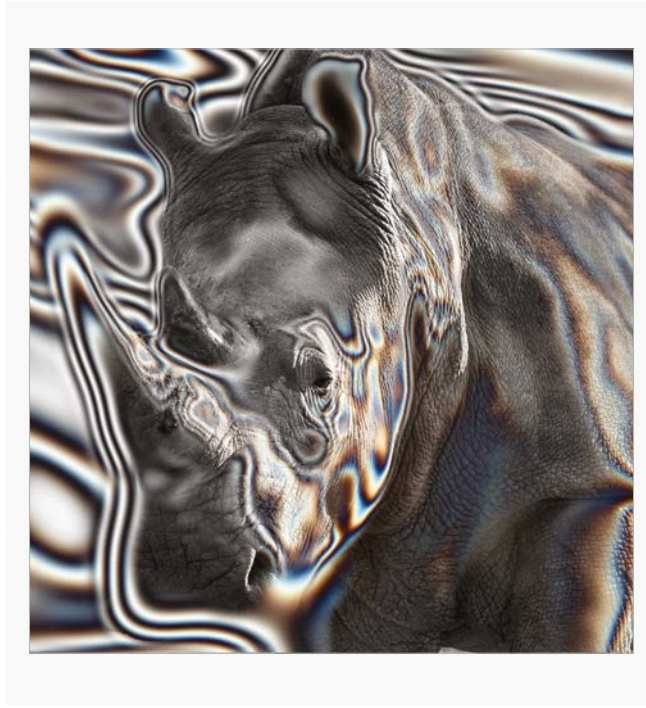

SN-006

Artist: SNYDER



SN-008



Jessica Incerti Telani

Artist: Jessica Incerti Telani

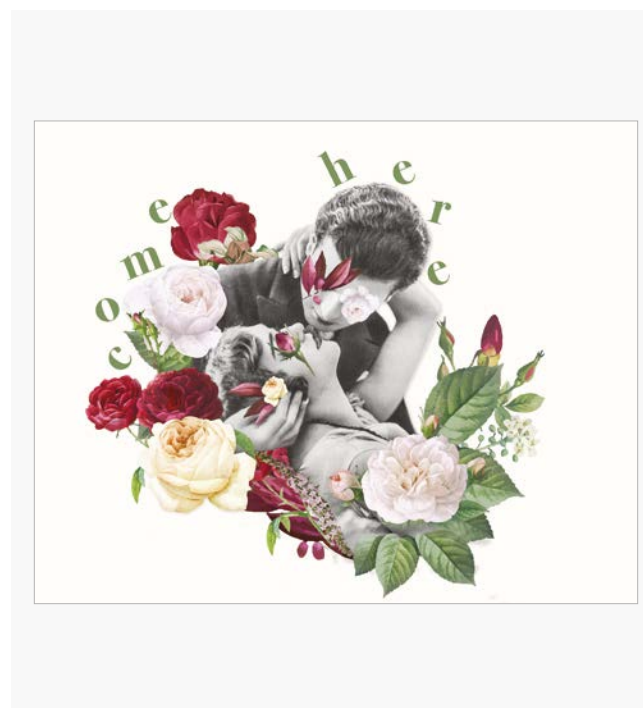

JE-001

Artist: Jessica Incerti Telani

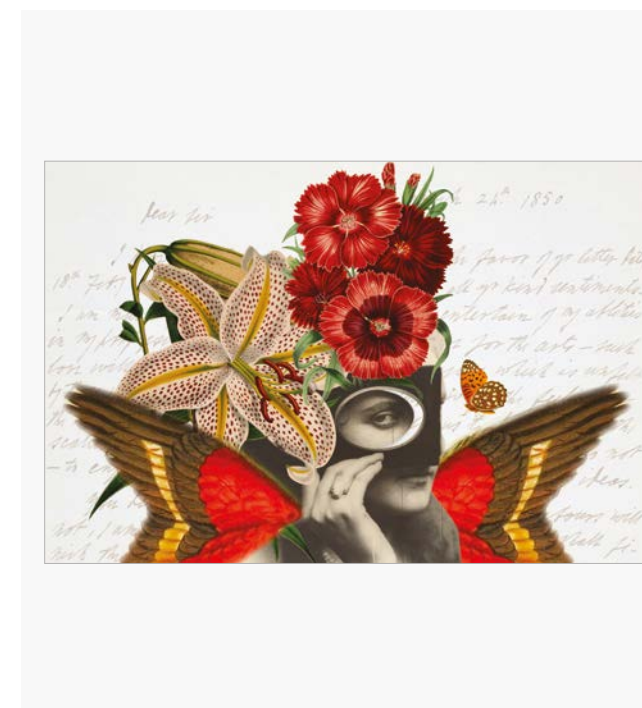

JE-002

Artist: Jessica Incerti Telani



JE-003

Artist: Jessica Incerti Telani

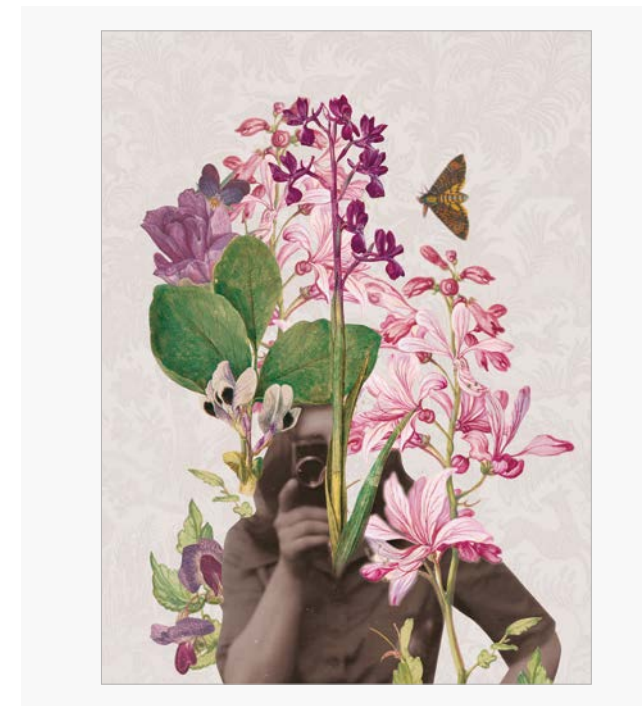

JE-004

83 anno in cui arrivo, numero di cui la somma ha un suono bellissimo: 11; le onde e le nuvole sono il mio ambiente naturale; metto insieme per sperimentare; non credo nell'ordine ma amo il metodo; imparo tanto e lentamente; dialogo coi più piccoli evitando le abitudini; associo per ricordare; viaggio per trasformarmi; vedo cose quando ancora non ci sono; prendo appunti temporanei ma una check-list sarà per sempre; il sud è casa.

/ 83 year in which I arrive, number of which the sum has a beautiful sound: 11; waves and clouds are my natural environment; I put together to experiment; I don't believe in order but I love method; I learn a lot and slowly; dialogue with the little ones avoiding habits; I associate to remember; I travel to transform myself; I see things when they are not there yet; I take temporary notes but a checklist will be forever; the south is home.

Artist: Jessica Incerti Telani

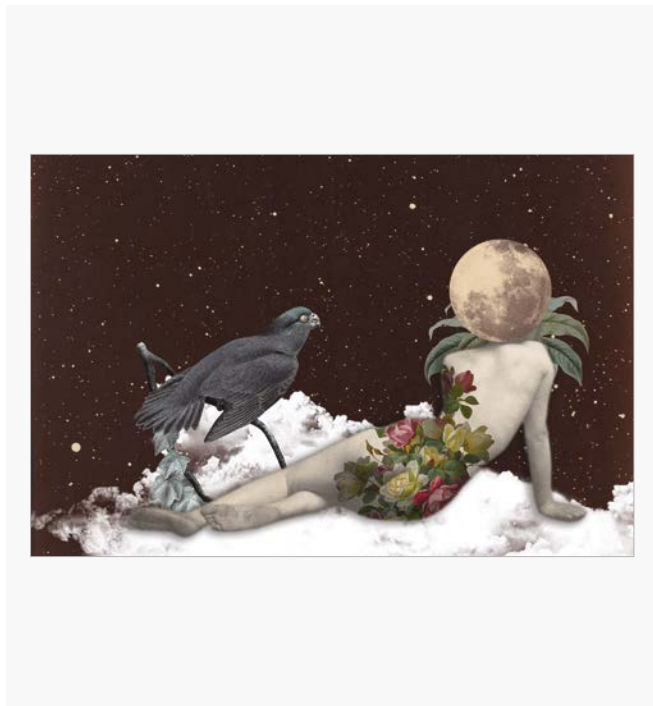

JE-005

Artist: Jessica Incerti Telani

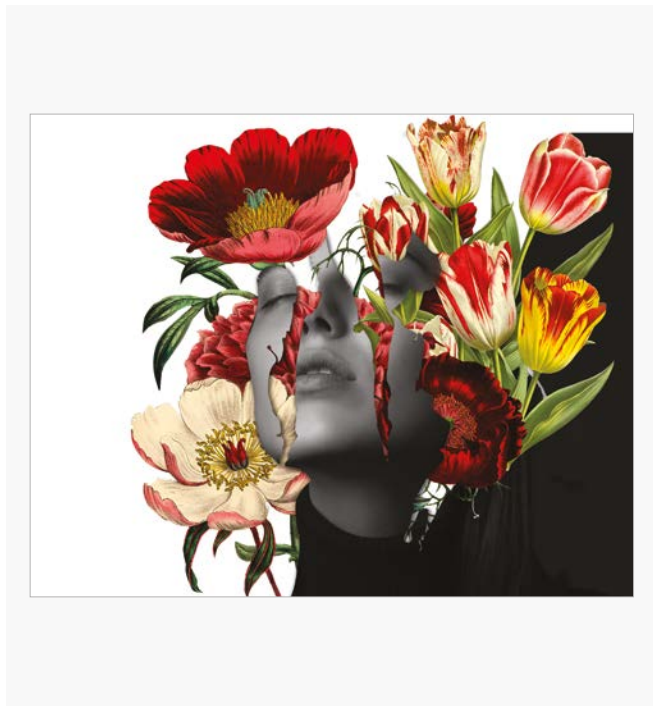

JE-006

Artist: Jessica Incerti Telani

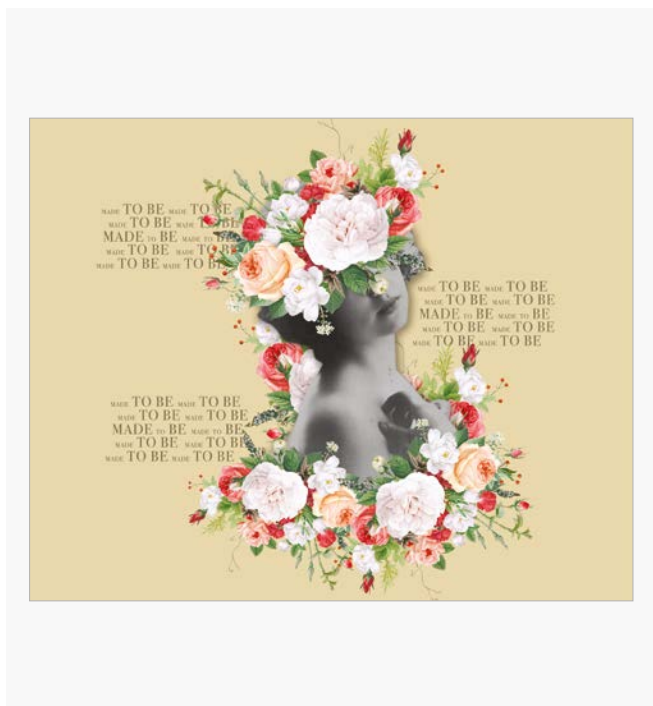

JE-007

Artist: Jessica Incerti Telani

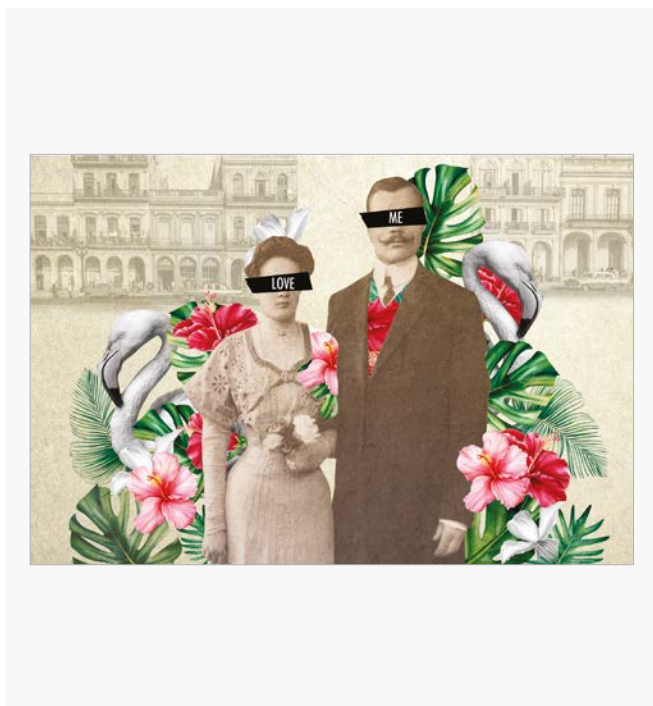

JE-008



Daniela Tzvetkova

Artist: Daniela Tzvetkova

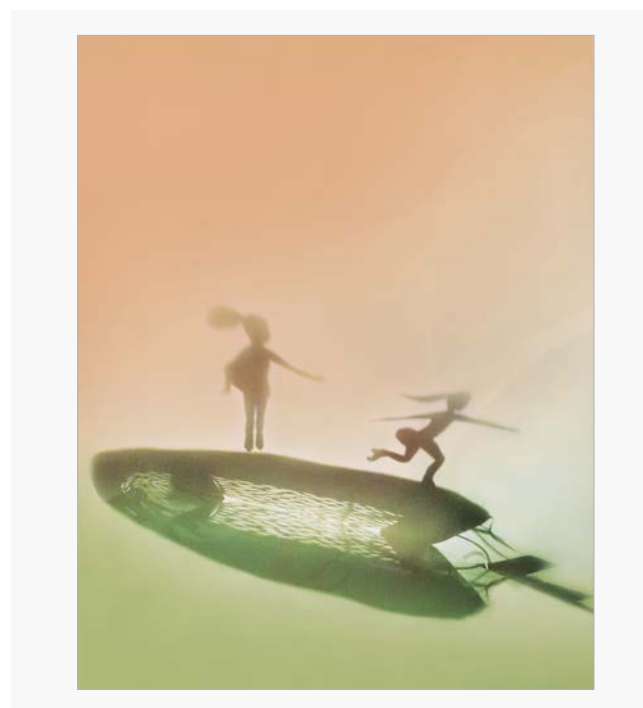

TZ-001

Artist: Daniela Tzvetkova



TZ-002

Artist: Daniela Tzvetkova

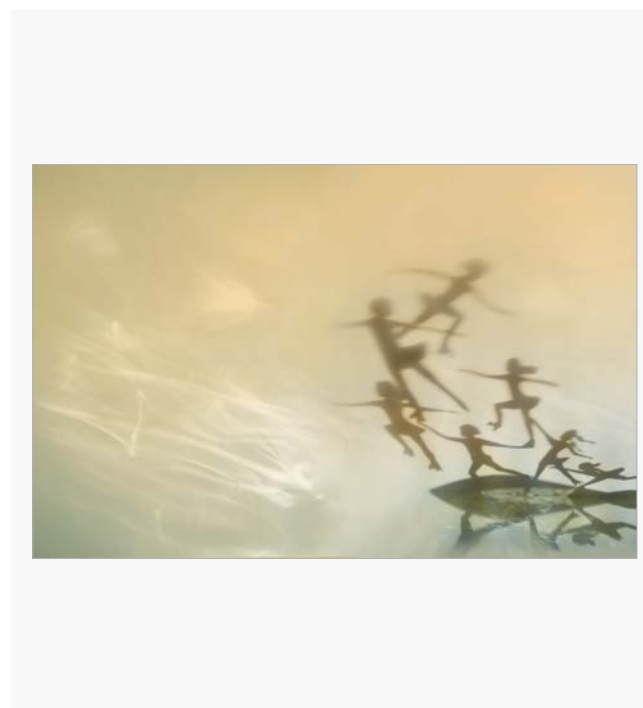

TZ-003

Artist: Daniela Tzvetkova

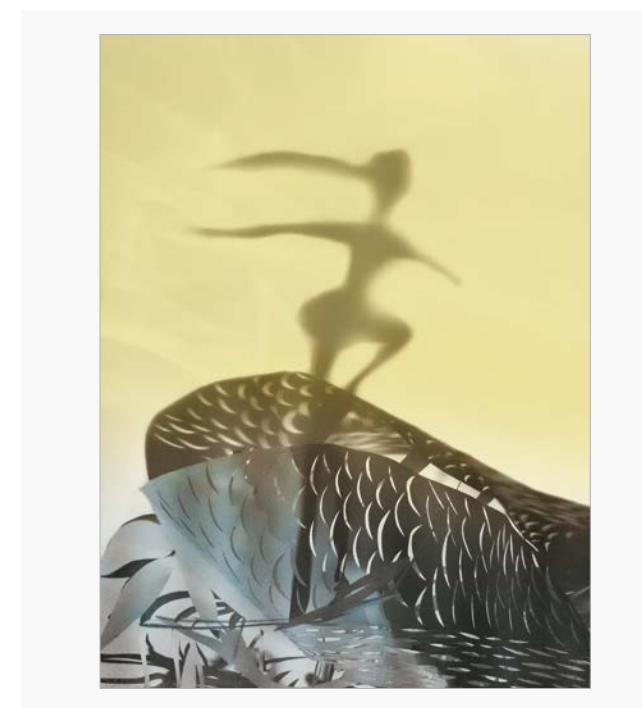

TZ-004

Scenografa e graphic designer di formazione, esplora le potenzialità della carta, trasformandola attraverso tecniche varie. L'artista bulgara e foggiana ha esposto precedentemente opere in carta nell'importante rassegna internazionale TRACARTE, organizzata dalla Banca del Monte e nel 2017 ha presentato le sue ricerche artistiche nel campo della serigrafia con pigmenti naturali (estratti da lei) presso la Galleria dell'Aps CREO (Foggia). Usando prevalentemente il colore blu e quello giallo racconta la magia della sua "lingua scritta" composta da forme, nervature, colori, textures ecc.

/ Trained set designer and graphic designer, she explores the potential of paper, transforming it through various techniques. The Bulgarian and Foggia artist previously exhibited paper works in the important international TRACARTE exhibition, organized by Banca del Monte and in 2017 presented her artistic research in the field of screen printing with natural pigments (extracted from her) at the Galleria dell' Aps CREO (Foggia). Using mainly blue and yellow colors, he tells the magic of his "written language" made up of shapes, ribs, colors, textures, etc.

Artist: Daniela Tzvetkova

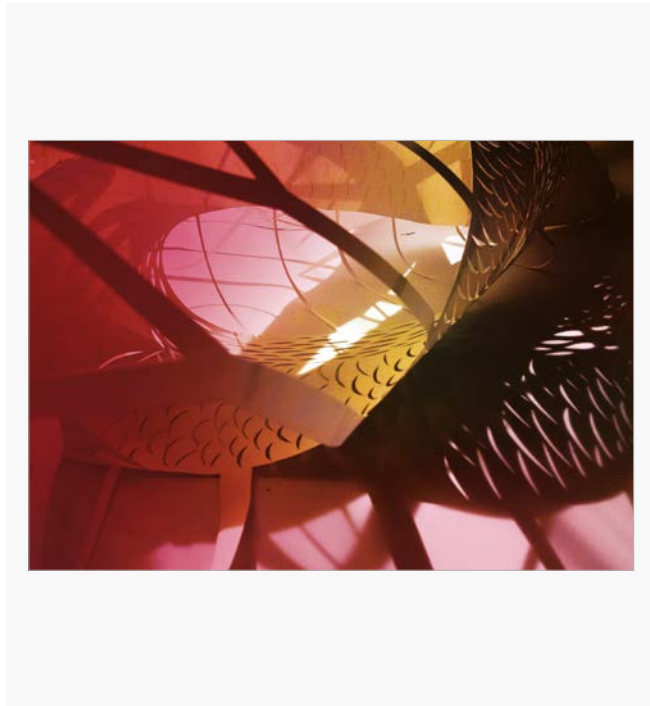

TZ-005

Artist: Daniela Tzvetkova



TZ-007

Artist: Daniela Tzvetkova



TZ-006

Artist: Daniela Tzvetkova

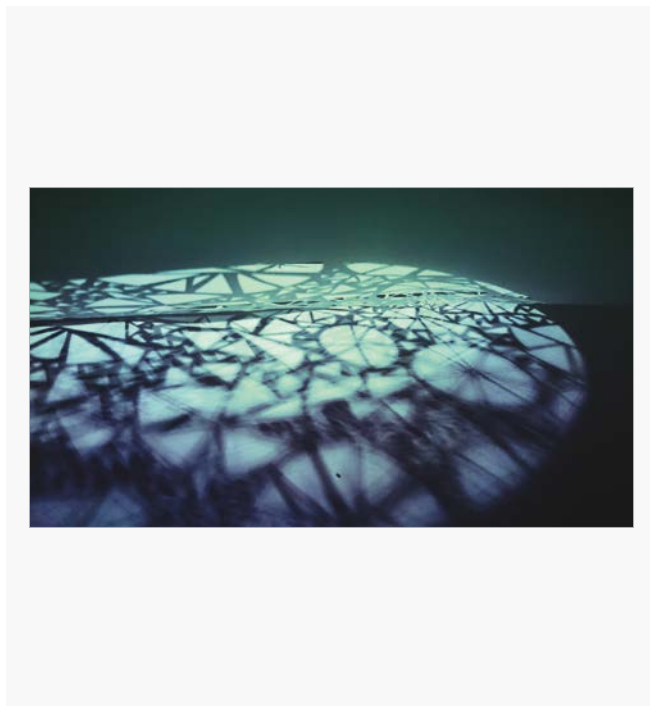

TZ-008



Momenti Lab

Artist: Momenti Lab



001

Artist: Momenti Lab



002

Artist: Momenti Lab

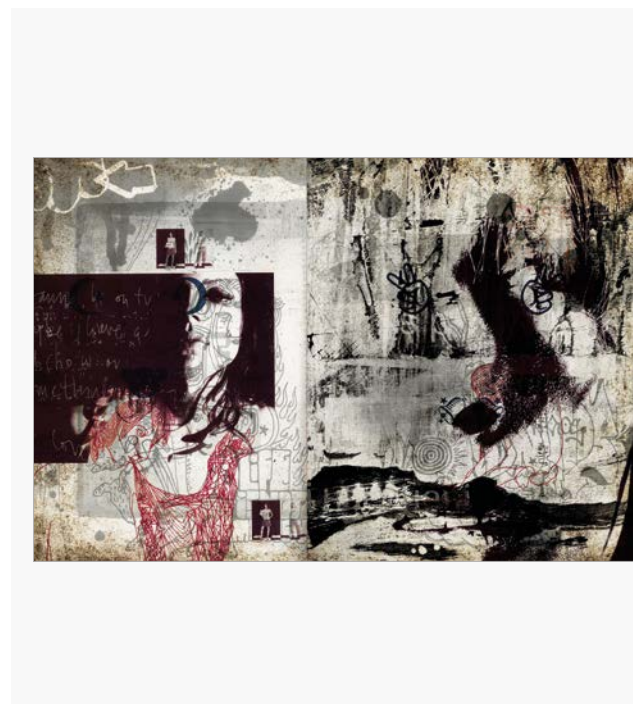

003

Artist: Momenti Lab



004

Il cuore operativo e artistico di MOMENTI. Tra tecnica, creatività, passione e un pizzico di follia, i membri del Laboratorio danno vita alle idee e alle atmosfere che contraddistinguono l'azienda.

/ The operational and artistic heart of MOMENTI. Between technique, creativity, passion and a pinch of madness, the members of the Lab give life to the ideas and atmospheres that distinguish the company.

Artist: Momenti Lab



005

Artist: Momenti Lab



006

Artist: Momenti Lab



009

Artist: Momenti Lab

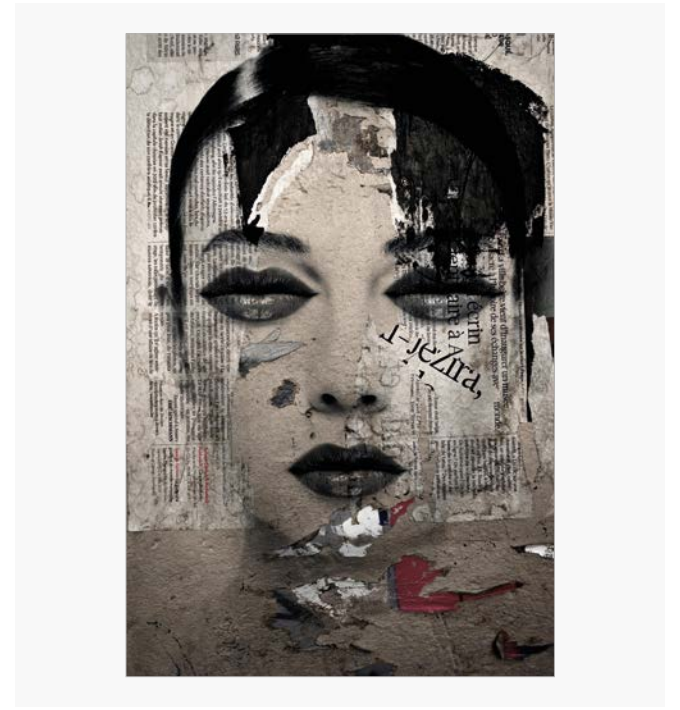

010

Artist: Momenti Lab



007

Artist: Momenti Lab

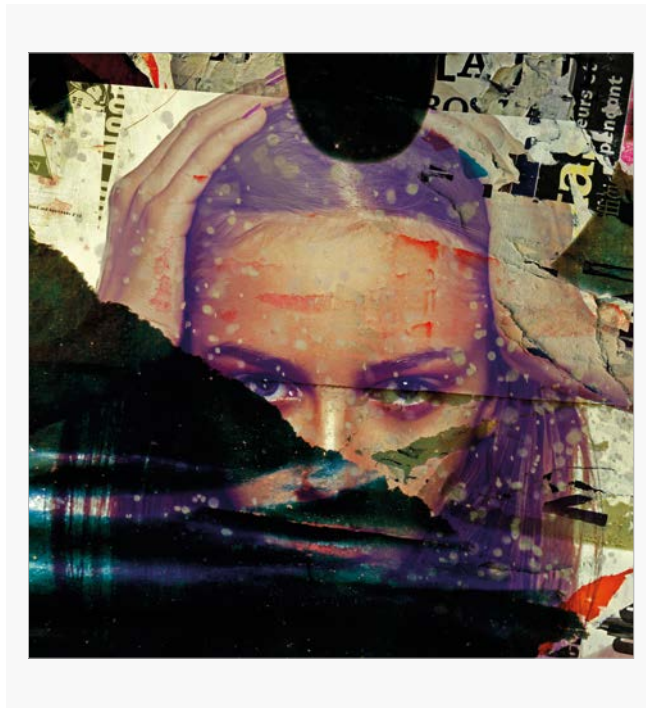

008

Artist: Momenti Lab

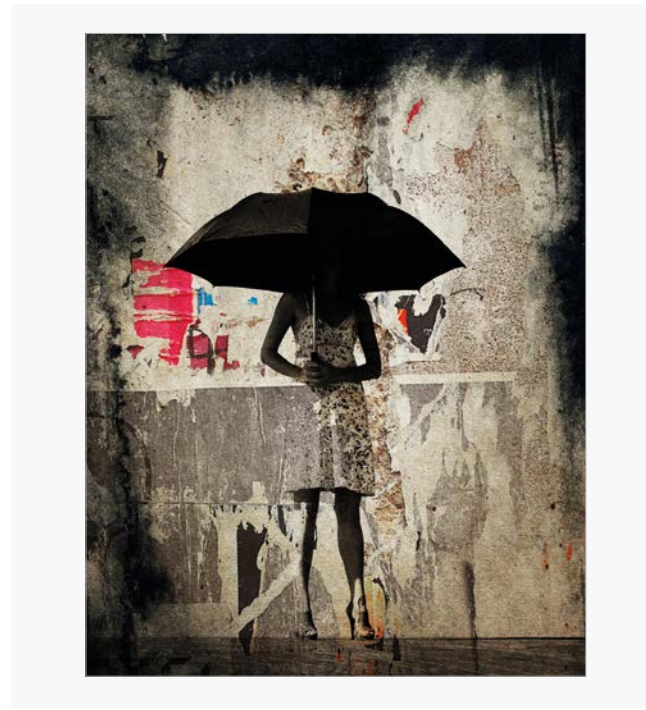

011

Artist: Momenti Lab

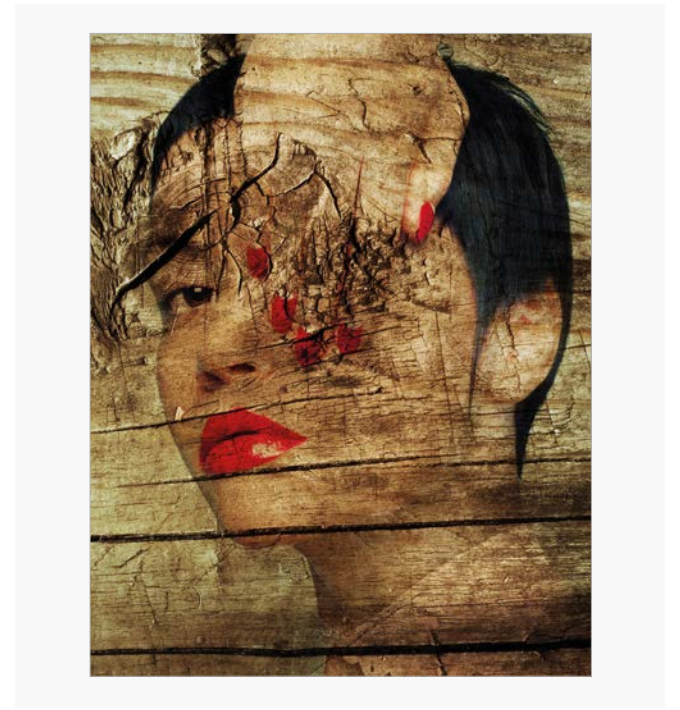

012

Artist: Momenti Lab



013

Artist: Momenti Lab



015

Artist: Momenti Lab



014

Artist: Momenti Lab



016



Artist: Momenti Lab

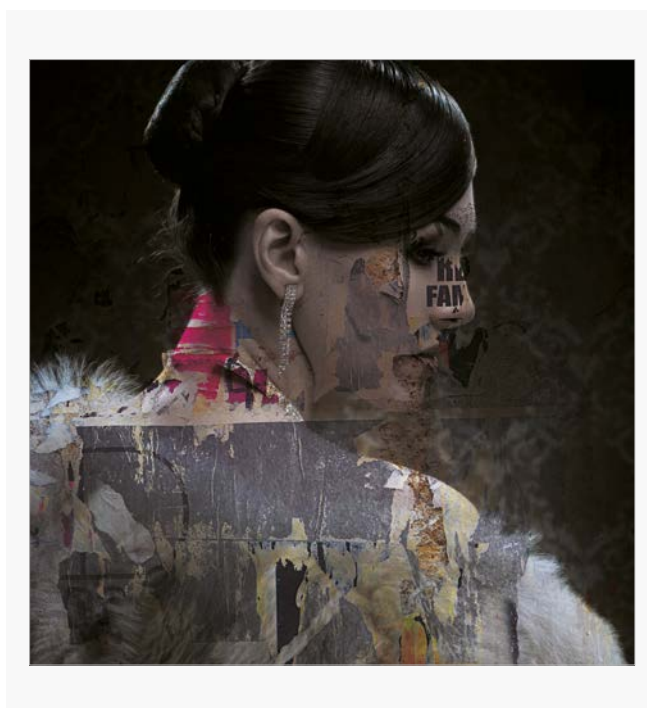

017

Artist: Momenti Lab



018

Artist: Momenti Lab

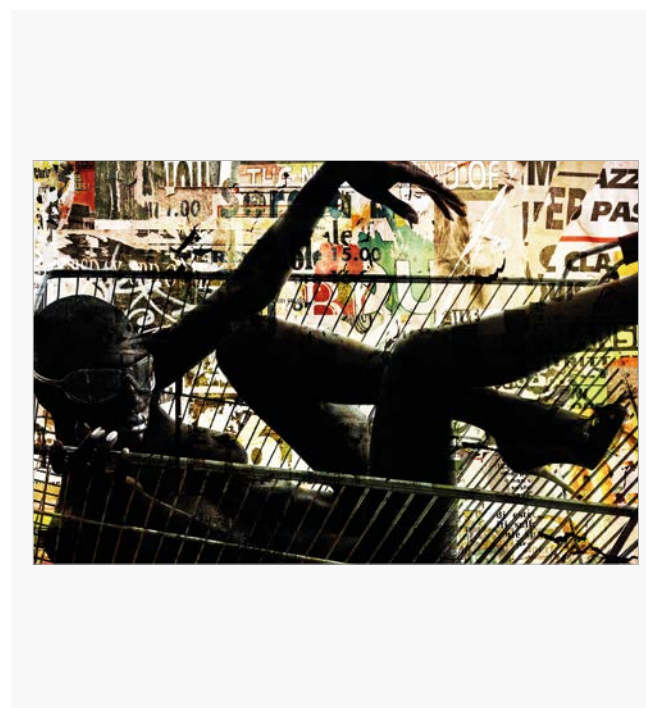

021

Artist: Momenti Lab

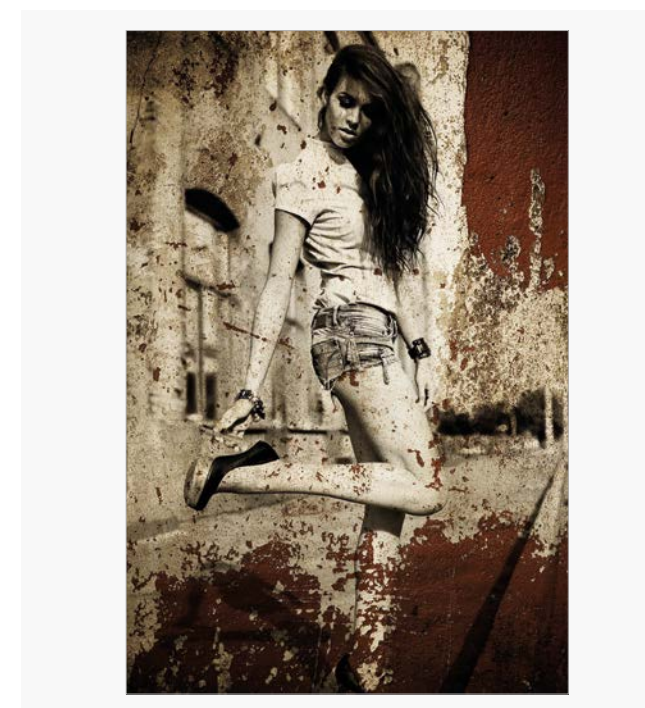

022

Artist: Momenti Lab



019

Artist: Momenti Lab

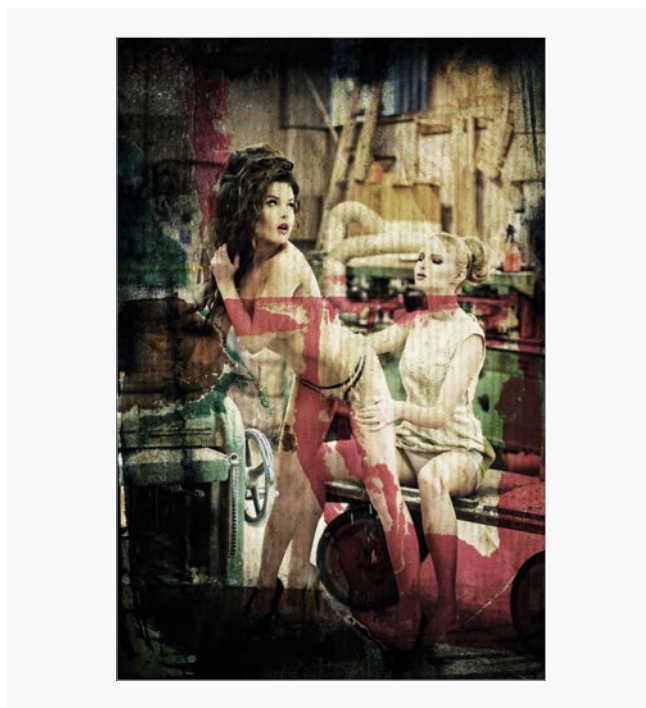

020

Artist: Momenti Lab

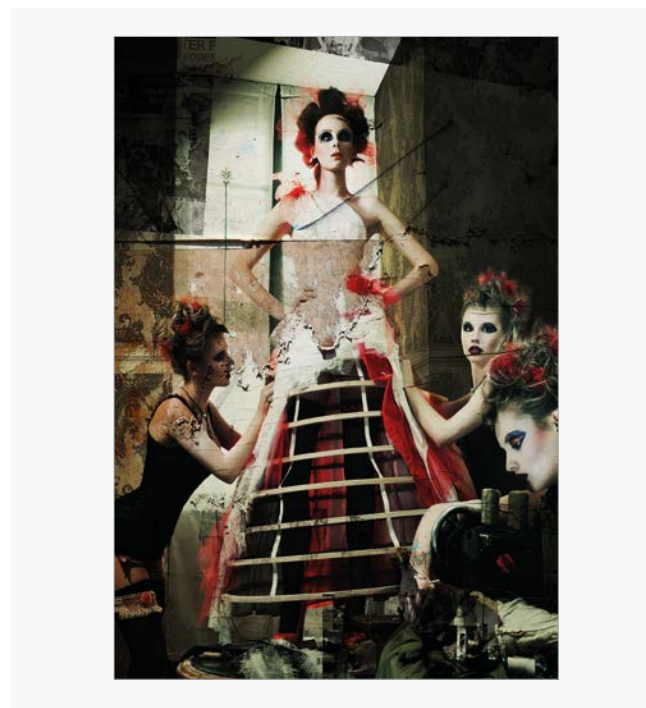

023

Artist: Momenti Lab

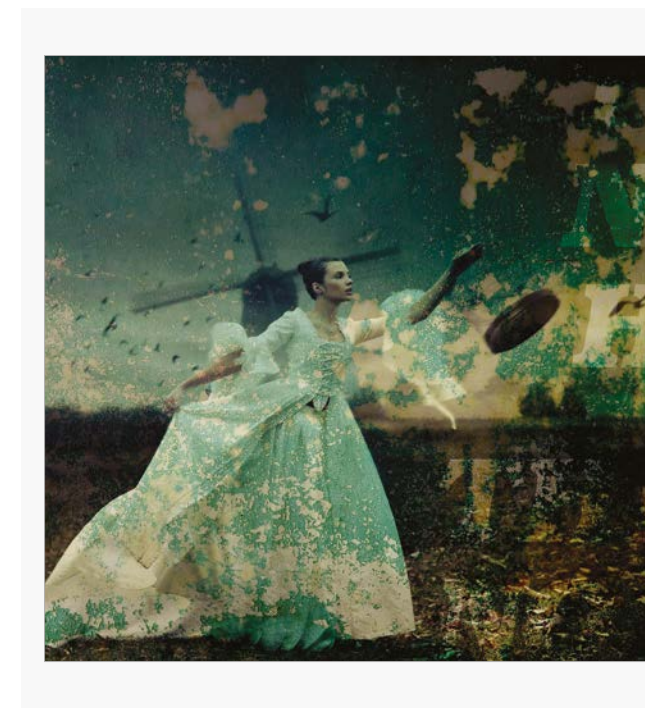

024



Artist: Momenti Lab

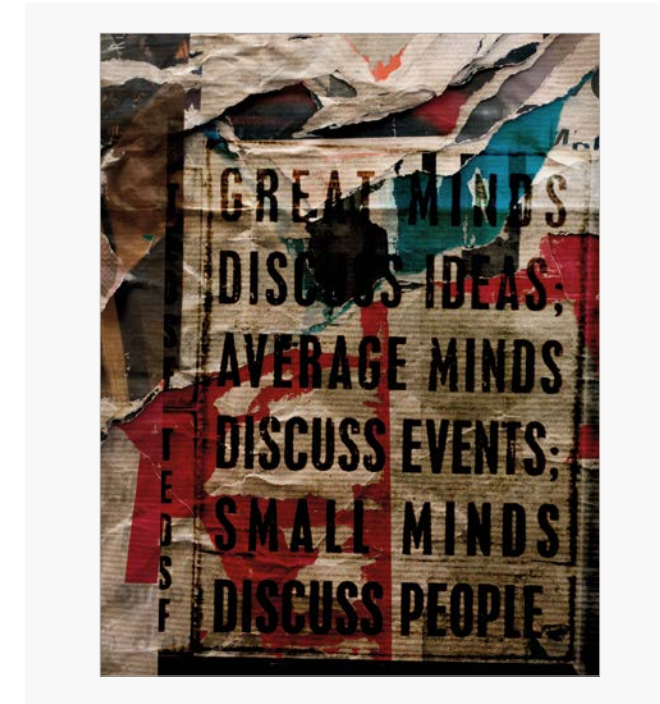

025

Artist: Momenti Lab



026

Artist: Momenti Lab

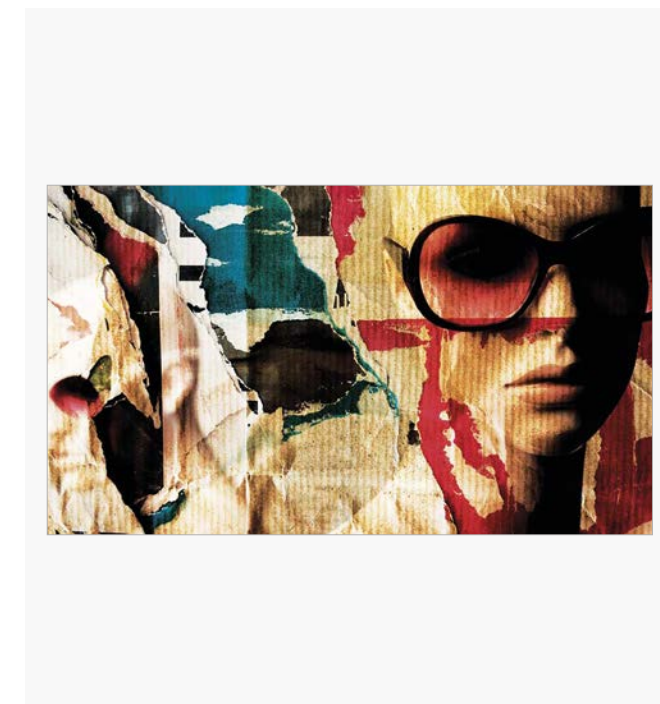

027

Artist: Momenti Lab

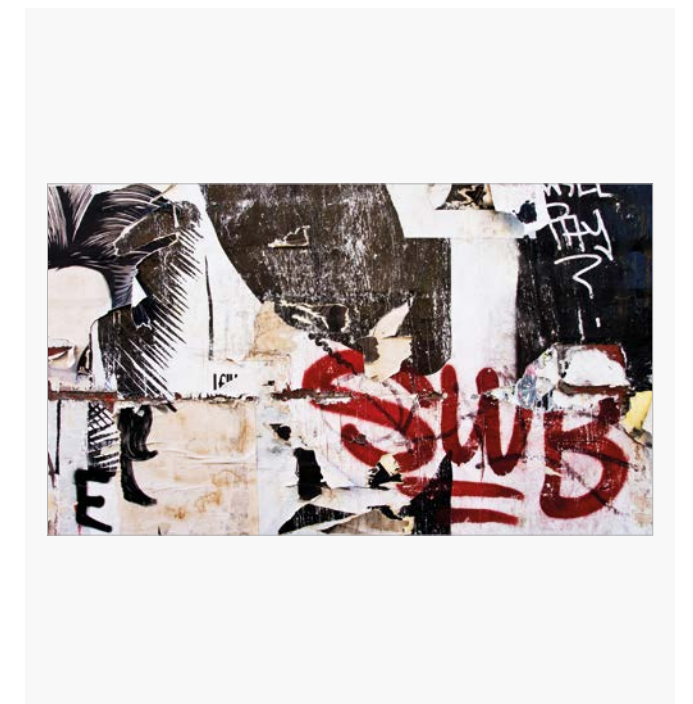

028

Artist: Momenti Lab



029

Artist: Momenti Lab



030

Artist: Momenti Lab



033

Artist: Momenti Lab



034

Artist: Momenti Lab



031

Artist: Momenti Lab

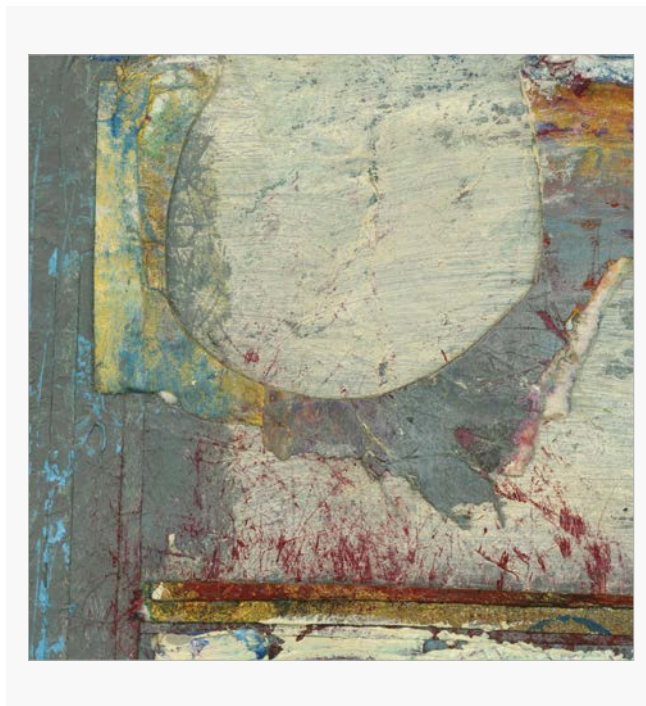

032

Artist: Momenti Lab



035

Artist: Momenti Lab



036

Artist: Momenti Lab



037

Artist: Momenti Lab

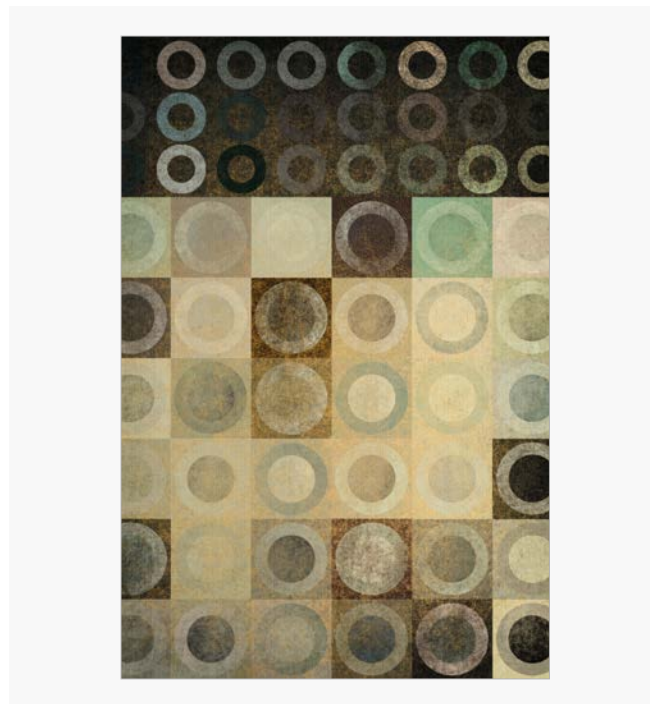

039

Artist: Momenti Lab

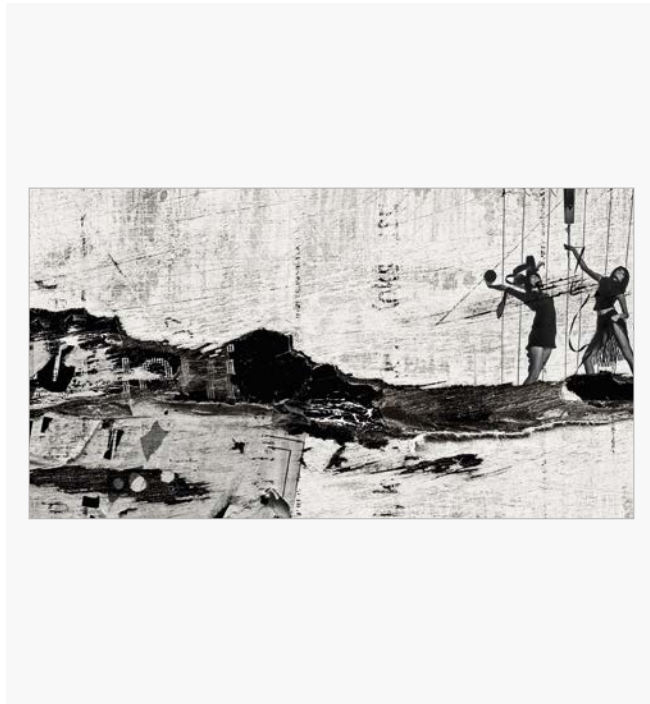

038

Artist: Momenti Lab



040



Artist: Momenti Lab

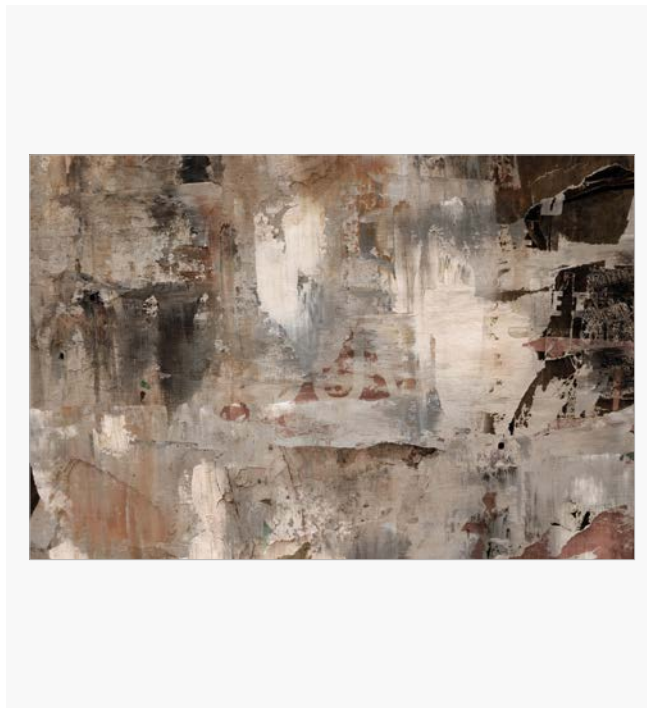

041

Artist: Momenti Lab



042

Artist: Momenti Lab



045

Artist: Momenti Lab

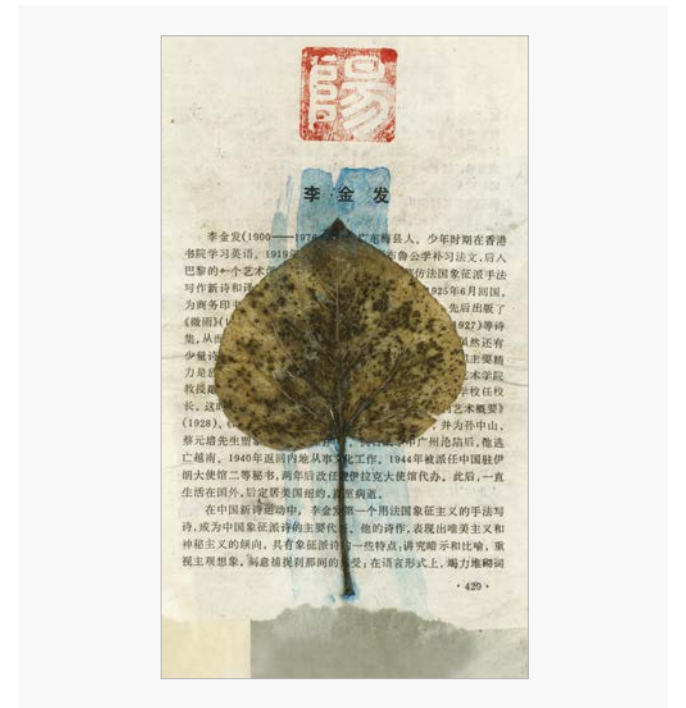

046

Artist: Momenti Lab



043

Artist: Momenti Lab

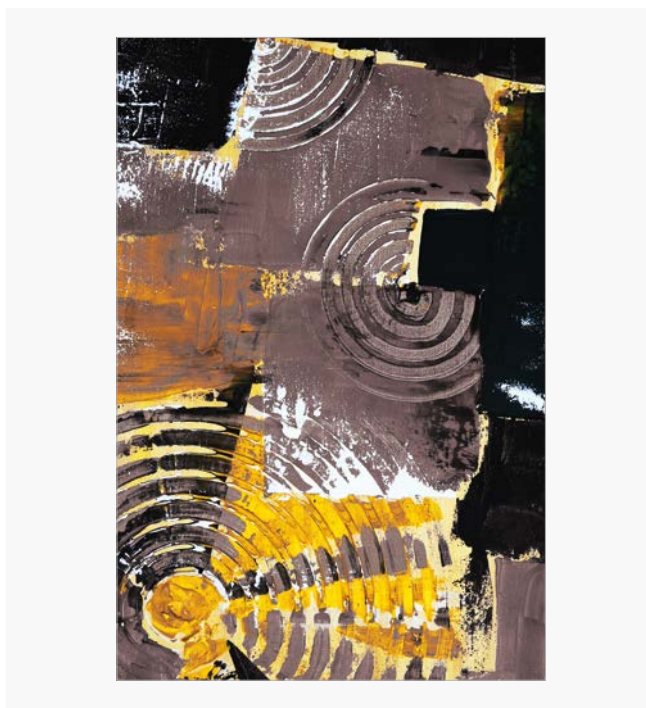

044

Artist: Momenti Lab

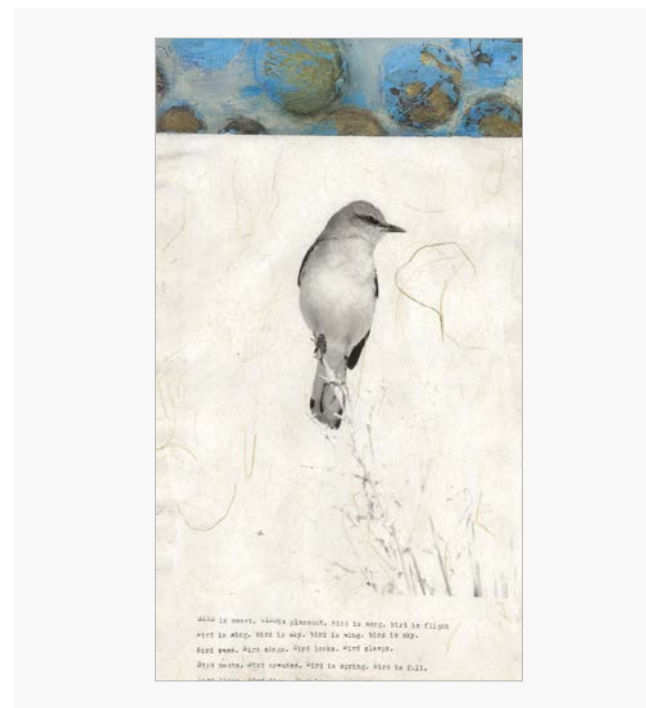

047

Artist: Momenti Lab



048



Artist: Momenti Lab

Artist: Momenti Lab



049

050

Artist: Momenti Lab

Artist: Momenti Lab



051

052



Artist: Momenti Lab



053

Artist: Momenti Lab

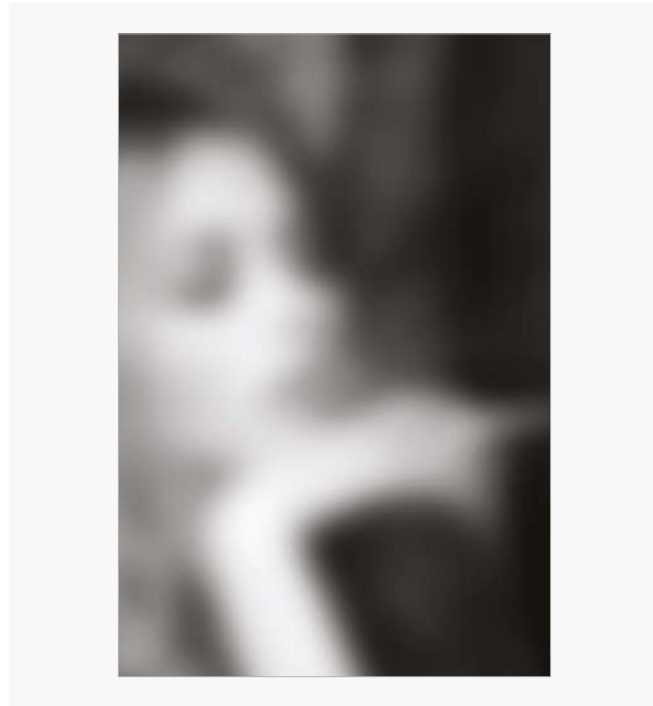

054

Artist: Momenti Lab

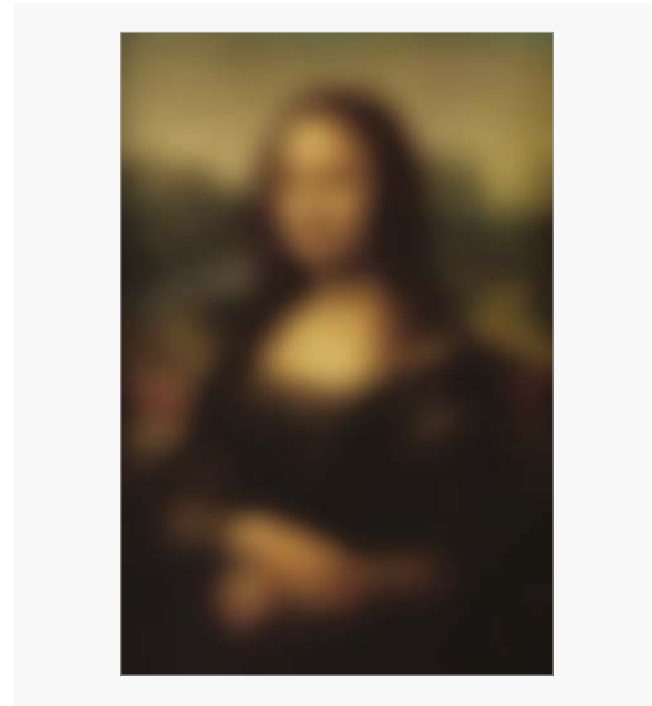

057

Artist: Momenti Lab



058

Artist: Momenti Lab



055

Artist: Momenti Lab



056

Artist: Momenti Lab



059

Artist: Momenti Lab

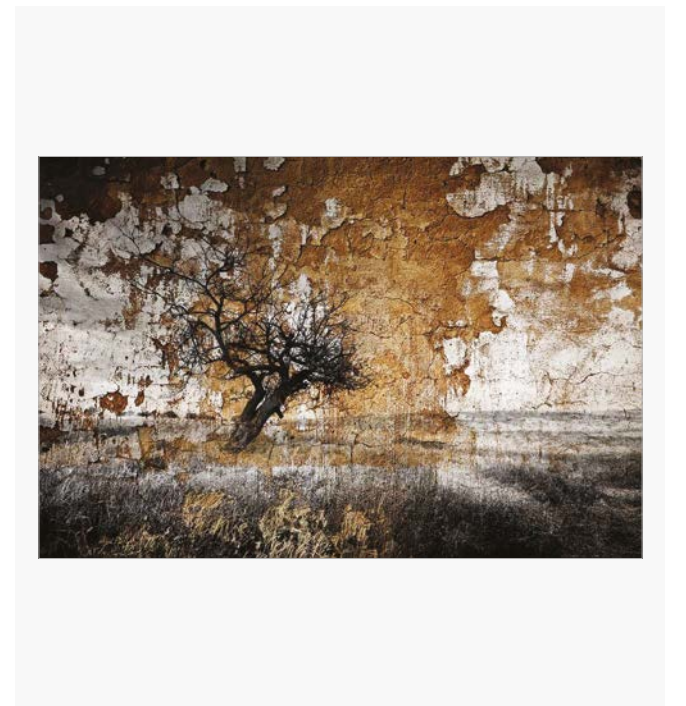

060

Artist: Momenti Lab

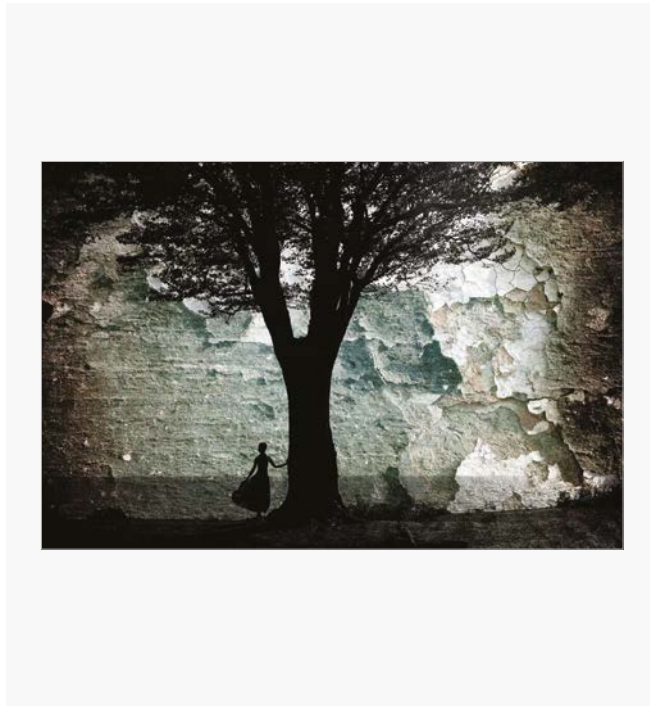

061

Artist: Momenti Lab



062

Artist: Momenti Lab

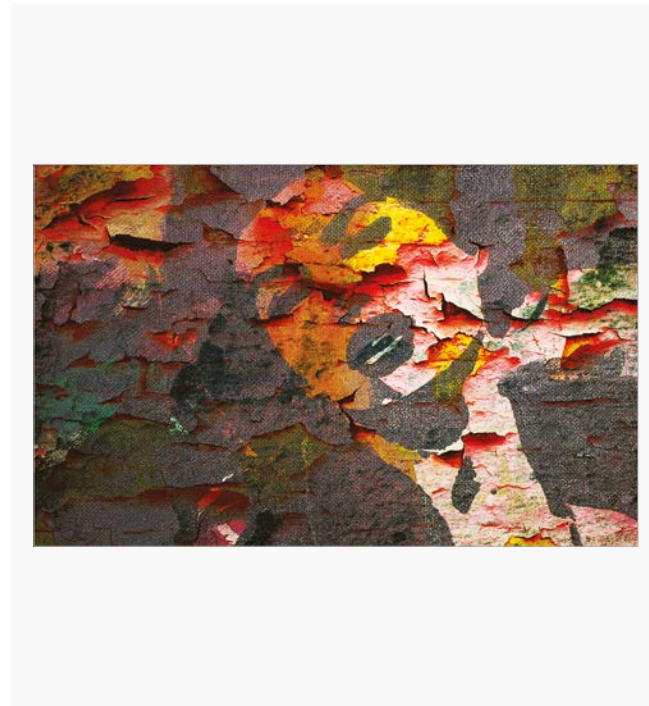

066

Artist: Momenti Lab

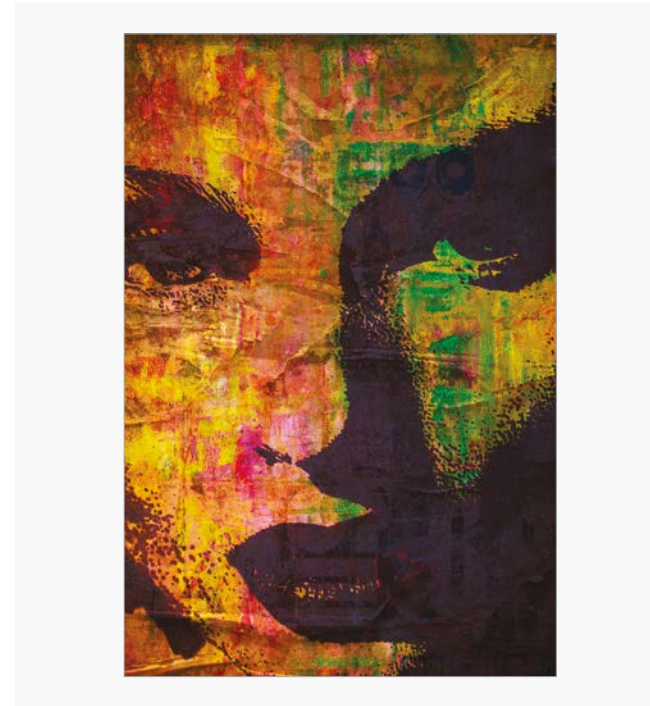

067

Artist: Momenti Lab



063

Artist: Momenti Lab

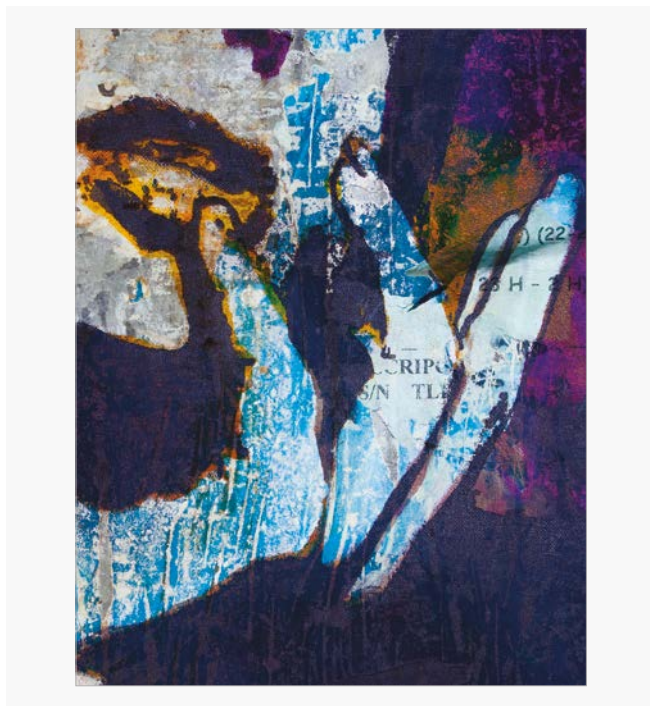

065

Artist: Momenti Lab



068

Artist: Momenti Lab



069

Artist: Momenti Lab



070

Artist: Momenti Lab



071

Artist: Momenti Lab



072

Artist: Momenti Lab



073



Artist: Momenti Lab



074

Artist: Momenti Lab

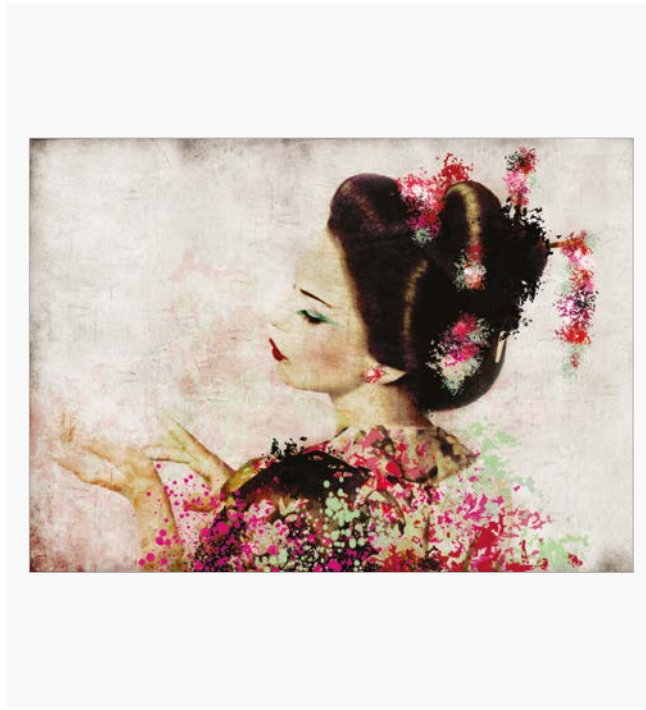

075

Artist: Momenti Lab

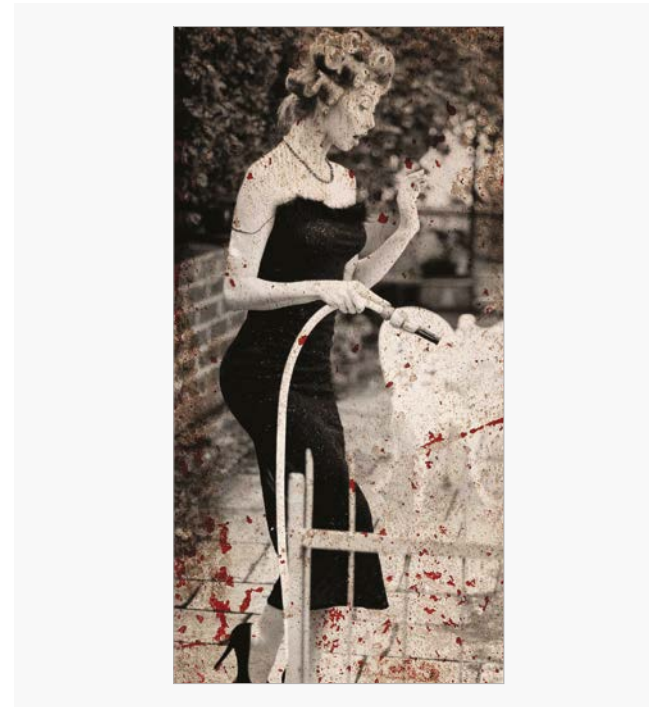

078

Artist: Momenti Lab

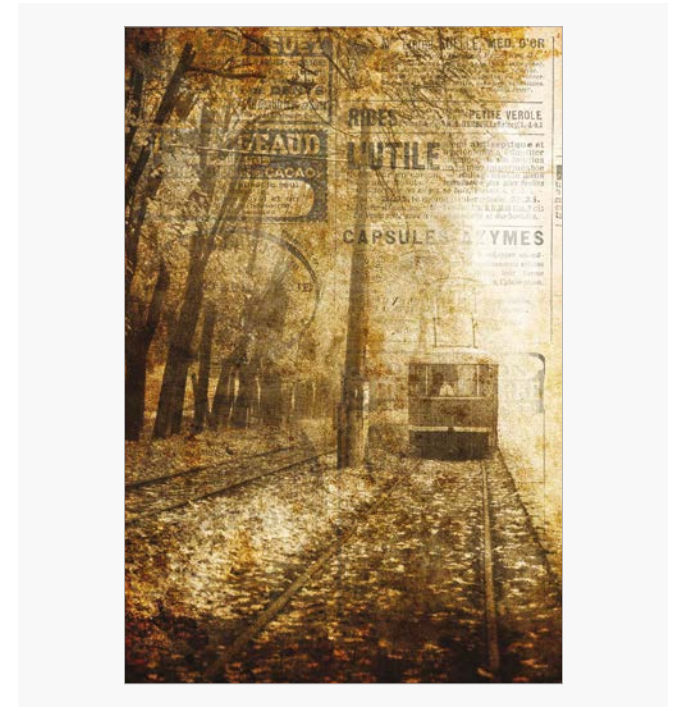

079

Artist: Momenti Lab

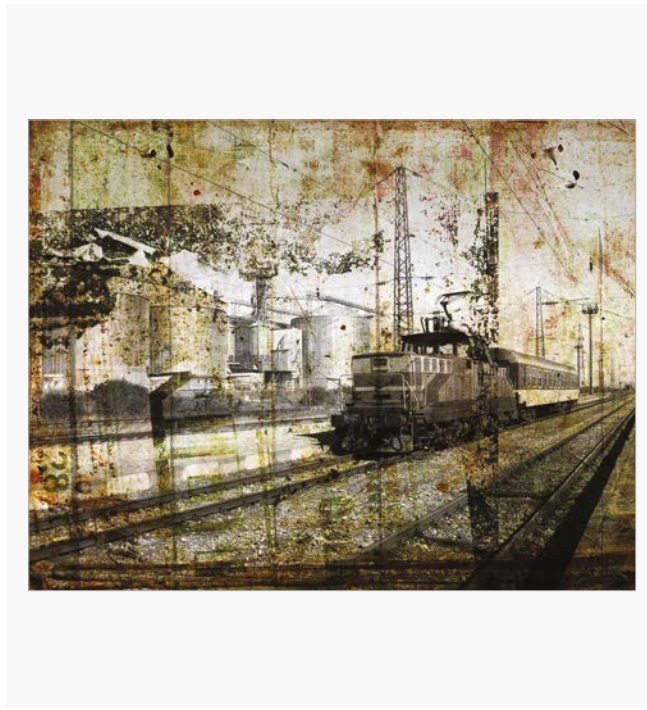

076

Artist: Momenti Lab



077

Artist: Momenti Lab



080

Artist: Momenti Lab



081

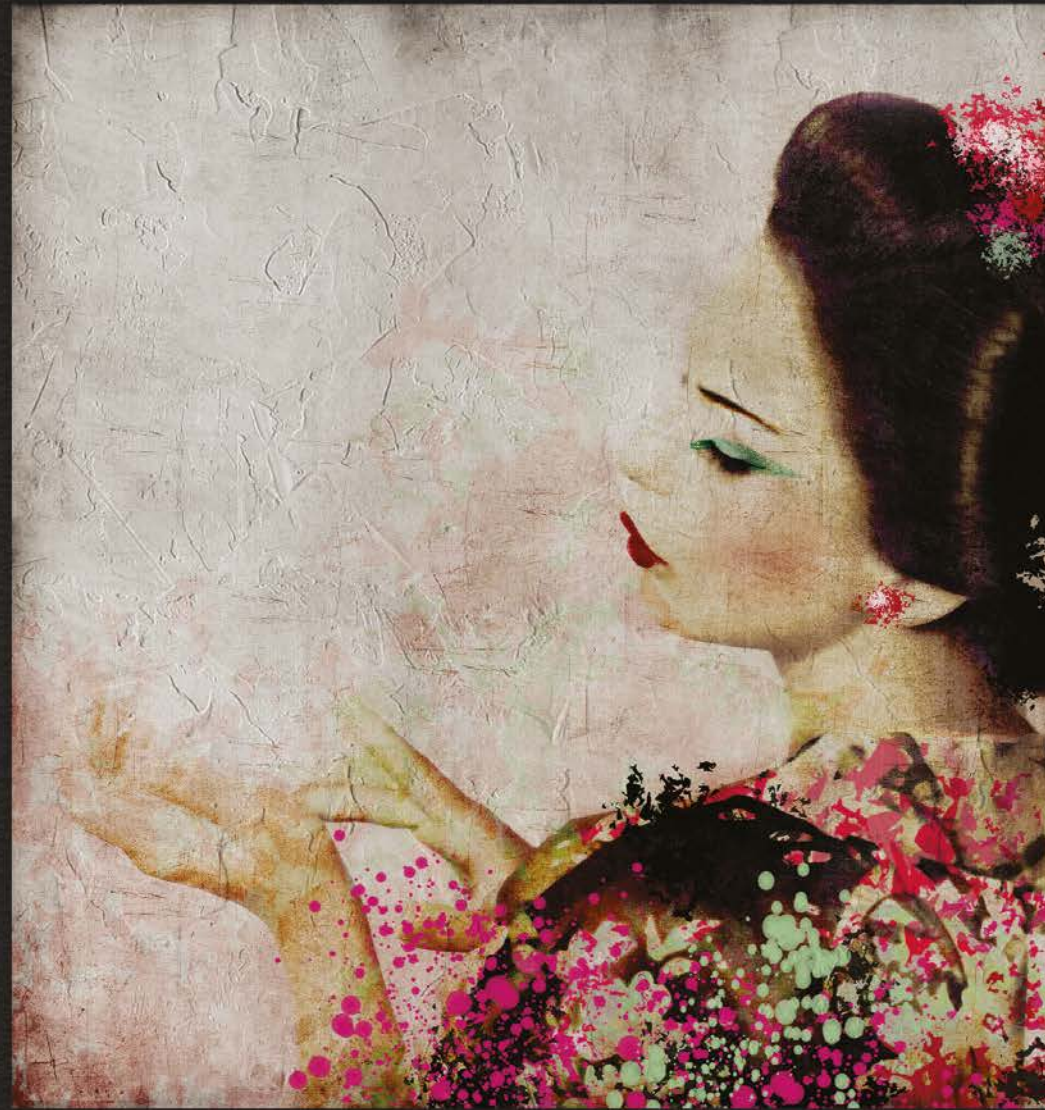

Artist: Momenti Lab

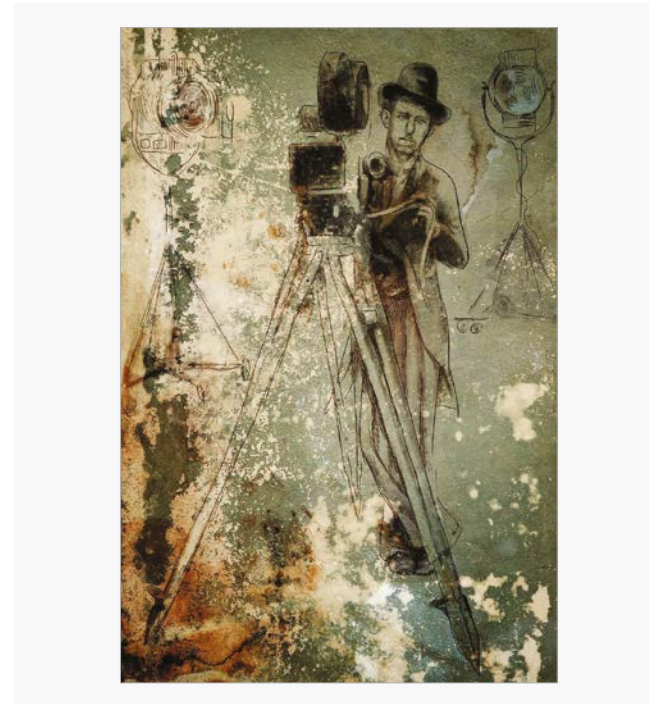

082

Artist: Momenti Lab



084

Artist: Momenti Lab



083

Artist: Momenti Lab



085

Informazioni tecniche
/ Technical info

Greenguard

Certificazione Greenguard



Tutti i prodotti Momenti sono stampati con sistema certificato GREENGUARD. La maggior parte dei composti organici volanti (VOC) dannosi per l'uomo presenti negli ambienti interni proviene da materiali da costruzione, arredi per interni, prodotti per la pulizia, la stampa, le ristrutturazioni interne e via dicendo. I risultati degli studi condotti nell'ambito hanno mostrato che il 96% dei VOC trovati in un edificio per uffici, ad esempio dopo la costruzione, deriva da materiali utilizzati per costruire e arredare quest'ultimo. Il Greenguard Environmental Institute (GEI) si occupa proprio di questo, dirige e amministra il programma di certificazione prodotti GREENGUARD. GEI è una organizzazione indipendente senza scopo di lucro, fondata per creare ambienti interni più sani, migliorando così la salute pubblica e la qualità della vita. Un comitato consultivo, formato da esperti nel campo della qualità dell'aria degli interni, della salute pubblica e di architettura ecosostenibile, sottopongono a revisioni il programma di certificazione GREENGUARD e ne garantiscono l'accettazione. I prodotti vengono misurati per le emissioni chimiche e di particelle, in quanto testati per simulare l'effettivo

utilizzo del prodotto. I livelli di emissione misurati vengono convertiti calcolando le concentrazioni di aria che rappresentano ciò che una persona effettivamente respirerà. Queste concentrazioni sono determinate in base all'uso previsto del prodotto, alla quantità di prodotto, al processo di applicazione e alle condizioni dell'edificio interno, inclusi volume dell'edificio e tasso di cambio dell'aria fresca. I prodotti certificati GREENGUARD devono soddisfare severi requisiti sulle emissioni chimiche, ad esempio essere sottoposti a screening per oltre 10.000 composti organici volatili (VOC). I prodotti sono sottoposti sia alla ricertificazione annuale che ai test trimestrali di monitoraggio della qualità per mantenere queste credenziali. La scienza, i solidi requisiti di certificazione e lo stato di terze parti che sostengono il programma di certificazione GREENGUARD differenziano i prodotti certificati sul mercato. Essere certificato da GREENGUARD significa che il prodotto e l'inchiostro con il quale è stato stampato sono stati testati contro le emissioni inquinanti all'interno degli edifici seguendo appunto, severi metodi di laboratorio come sopra citato.

/ Greenguard

/ Greenguard Certification



/ All products in the Momenti collection are printed with GREENGUARD certified system. The majority of VOCs found in the indoor environments originate from building materials, indoor furnishings, cleaning supplies, printing, cooking, hobbies, cleaning, and interior renovations. Results from studies conducted showed that 96% of the VOCs found in a large office building following construction resulted from the materials used to construct and furnish the building. The Greenguard Environmental Institute (GEI), an independent and non-profit organization founded to create healthier indoor environments, improving public health and life standards, manages and administer the GREENCARD PRODUCT CERTIFICATION PROGRAM. An advisory committee, consisting of experts in the field of indoor air quality, public health and eco-friendly architecture, submits to revision the GREENGUARD Certification Program and ensures its acceptance. The products are measured for chemical and particle emissions, as they are tested to simulate the actual use of the product.. Measured emission levels are converted by calculation to air concentrations representing what a person will actually breathe. These concen-

trations are determined based on expected use of the product, amount of product, application process and the indoor building conditions, including building volume and fresh air exchange rate. GREENGUARD Certified products must meet stringent chemical emissions requirements, such as being screened for more than 10,000 volatile organic compounds (VOCs). Products undergo both annual re-certification and quarterly quality monitoring tests to maintain these credentials. The science, robust certification requirements, and third-party status that back the GREENGUARD Certification program differentiate certified products in the marketplace. Being certified by GREENGUARD means that the product and the ink with which it was printed were both tested against the emission of pollutants inside the buildings following, strict laboratory methods aforementioned.

Painting

Ecopannello alveolare con rivestimento materico / Alveolar ecopanel with material covering

Stampa artistica su ecopannello alveolare, con rivestimento materico superficiale applicato a mano e finitura protettiva opaca atossica

/ Artistic print on alveolar ecopanel, with surface materic cover applied by hand and non-toxic opaque protective finish

Ecopannello in cellulosa 100%, riciclata e riciclabile, con kraft bianco in cellulosa. Questo tipo di supporto è ecologico, riciclato, riciclabile al 100%, leggero ed economico. Sulla superficie è applicato a mano il nostro rivestimento materico superficiale resistente, idrorepellente, atossico, ecologico, privo di odori. Finitura protettiva opaca. Predisposto per aggancio a parete.

/ 100% recycled and recyclable cellulose panel with cellulose white kraft. This type of support is environmentally friendly, recycled, 100% recyclable, light and economical. On the surface, our resistant, water-repellent, non-toxic, environmentally friendly, odor-free materic covering is hand applied. Protective opaque finish. Wall hardware included.



Painting

PMMA
/ PMMA

Stampa artistica su pannello in PMMA
/ Artistic print on PMMA panel

Il polimetilmetacrilato (PMMA) è una materia plastica formata da polimeri del metacrilato di metile. Possiede caratteristiche di comportamento assimilabili alla fibra ottica per qualità e trasparenza ed è, a seconda delle percentuali di composizione, infrangibile. Momenti utilizza esclusivamente PMMA prodotto in Italia, riciclato, riciclabile al 100% e certificato da enti preposti. Predisposto per aggancio a parete.

/ Polymethyl methacrylate (PMMA) is a plastic material formed of methyl methacrylate polymers. It possesses behavioral characteristics similar to optical fiber in terms of quality and transparency and it is unbreakable, according to the percentage of composition. Momenti uses only PMMA produced in Italy, recycled, 100% recyclable and certified by the competent authorities. Wall hardware included.



Painting

Alluminio con rivestimento materico / Aluminium with material covering

Stampa artistica su pannello in alluminio, con rivestimento materico superficiale applicato a mano e finitura protettiva opaca atossica
/ Artistic print on aluminium panel, with surface materic cover applied by hand and non-toxic opaque protective finish

Pannello composto in lega di alluminio, con interposto un core di polietilene, che è il più semplice dei polimeri sintetici e il più presente in natura. Sulla superficie è applicato a mano il nostro rivestimento materico superficiale resistente, idrorepellente, atossico, ecologico e privo di odori. Finitura protettiva lucida atossica. Predisposto per aggancio a parete.

/ Panel made of aluminum alloy, with interposed a core of polyethylene, which is the simplest of synthetic polymers and the most present in nature. On the surface, our resistant, water-repellent, non-toxic, environmentally friendly and odor-free materic covering is hand applied. Non-toxic glossy protective finish. Wall hardware included.



Painting

Telato in alluminio con rivestimento
in tessuto "Tecno Fiber"

/ Aluminium canvas with "Tecno Fiber" fabric covering

Stampa artistica su pannello scatolato in lega di alluminio. Rivestito esternamente a
mano con tessuto tecnico di rivestimento in fibra di vetro Tecno Fiber

/ Artistic print on boxed aluminium panels. Exterior manually covered with
printed technical covering fiberglass fabric Tecno Fiber

Pannello scatolato in lega di alluminio, rivestito
esternamente con tessuto tecnico in fibra di vetro
Tecno Fiber. Finitura protettiva opaca effetto vinta-
ge. Predisposto per aggancio a parete.

Attenzione: i colori potrebbero variare dalla stampa sul
catalogo e/o video al prodotto finito.

/ Boxed panel in aluminium alloy, externally cover-
ed with Tecno Fiber technical covering fiberglass
fabric. Vintage effect opaque protective finish. Wall
hardware included.

Attention: the colors may change from the printing on
this catalog and/or video to the finished product.

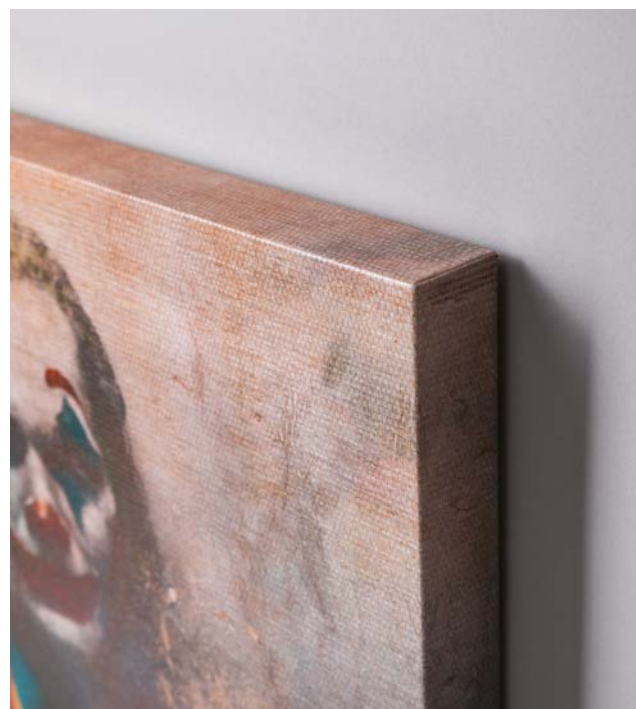

Painting

Fonoassorbente con polietilene e poliestere acustico con stampa artistica

/ Sound absorbing with acoustic polyethylene and polyester with art print

Stampa artistica su pannello fonoassorbente con struttura perimetrale e interna in legno massello, con rivestimento interno in polietilene acustico "Strato Isolant". Rivestimento superficiale, perimetrale e retro in poliestere acustico "Acoustic Fiber" realizzato con stampa artistica

/ Artistic print on sound absorbent panel with perimeter and internal structure in solid wood, with internal covering in acoustic polyethylene "Strato Isolant". Surface, perimeter and back coating in "Acoustic Fiber" acoustic polyester made with artistic print

Pannello scatolato con struttura in mdf, rivestito esternamente con poliestere acustico. Rivestimento interno in materiale fonoassorbente denominato Strato Isolant da 4 cm.

/ Boxed panel with mdf structure, coated externally with acoustic polyester. Internal coating in sound absorbing material called Strato Isolant 4 cm.



Painting

Fonoassorbente in lana di vetro con stampa artistica / Sound absorbing glass wool with artistic print

Pannello "solo-rectangle ecophon" in lana di vetro ad alta densità con struttura totalmente porosa di spessore 40 mm con stampa eco-digitale
/ "Solo-rectangle ecophon" panel in high density glass wool with a totally porous structure of 40 mm thickness with eco-digital print

Pannello fonoassorbente, composto da un'anima in lana di vetro ad alta densità, incapsulato in una pellicola (pittura acustica) levigata ad alte prestazioni di colore bianco con stampa artistica ecologica e digitale.

La finitura del telaio è in massello di legno verniciato a poro aperto opaco con colore Bianco Ral 9010 o Nero Ral 9005.

Possibilità a richiesta di stampare il pannello in lana di vetro su entrambi i lati, con la possibilità di cambiare immagine al quadro.

/ Sound-absorbing panel, composed of a high-density glass wool core, encapsulated in a high-performance, white-colored smoothed film (acoustic paint) with ecological and digital art print. The frame finish is in solid wood with matt open pore varnish in White Ral 9010 or Black Ral 9005. Possibility on request to print the glass wool panel on both sides, with the possibility of changing the image of the picture.



Painting

Aggancio a parete / Wall Mounting



Ecopannello Alveolare
/ Alveolar Ecopanel

Pannello in PMMA
/ PMMA Panel

Pannello in Alluminio
/ Aluminium Panel



Pannello Telato
/ Canvas Panel

Pannello Fonoassorbente
con poliestere acustico
/ Sound absorbing Panel
with acoustic polyester

Pannello Fonoassorbente
in lana di vetro
/ Sound absorbing
in wool glass Panel

Painting

Aggancio a parete / Wall Mounting

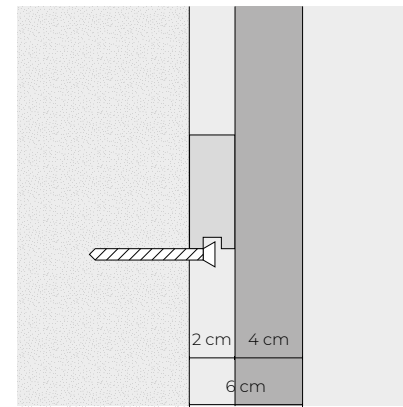

Ecopannello Alveolare
/ Alveolar Ecopanel

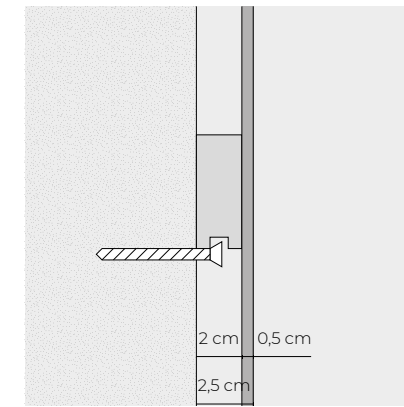

Pannello in PMMA
/ PMMA Panel

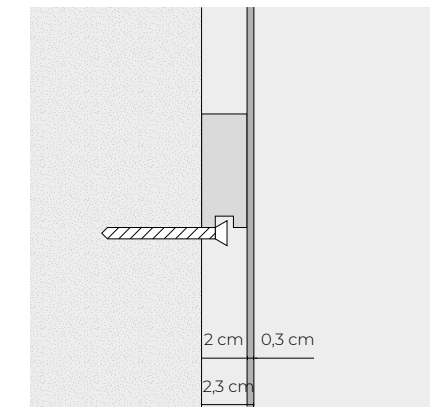

Pannello in Alluminio
/ Aluminium Panel

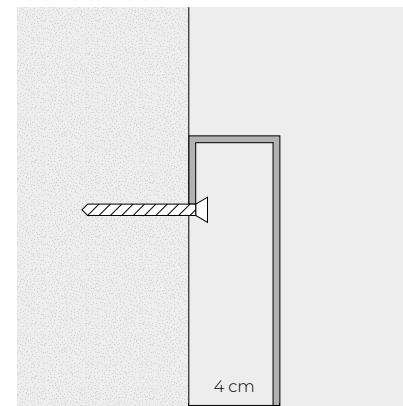

Pannello Telato
/ Canvas Panel

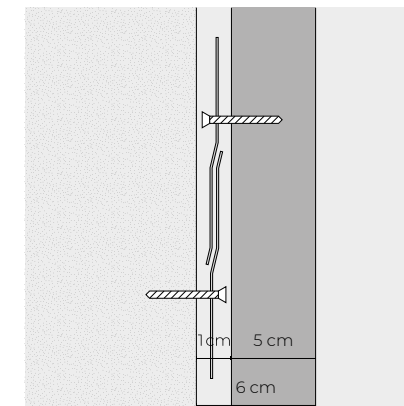

Pannello Fonoassorbente
con poliestere acustico
/ Sound absorbing Panel
with acoustic polyester

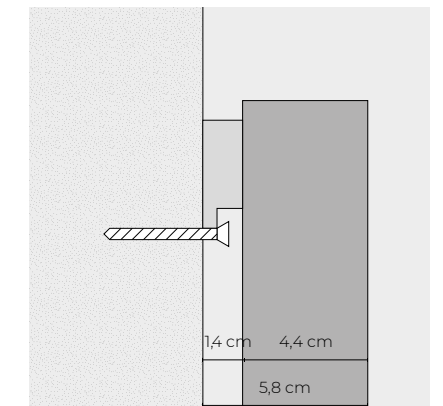

Pannello Fonoassorbente
in lana di vetro
/ Sound absorbing
in wool glass Panel

Personalizzazione grafica / Graphic customization

Le tonalità cromatiche delle immagini/grafiche, visualizzate su monitor, sito internet, brochure e/o sul presente catalogo, potrebbero differire dalle immagini stampate sul prodotto finito, poiché la stampa fornisce diversi risultati a seconda del prodotto e della materia prima di supporto.

Di conseguenza il Committente, confermando l'ordine, accetta tali tolleranze e tali caratteristiche, che non potranno quindi essere oggetto di contestazione alcuna.

Creazione di grafica personalizzata

Tutte le grafiche possono essere ordinate nella loro versione standard, come visibili sul presente catalogo, oppure riadattate alle esigenze del cliente tramite personalizzazione.

Le grafiche possono anche essere realizzate utilizzando una o più immagini fornite dal cliente, oppure elaborate dal nostro Momenti Lab seguendo le esigenze dell'acquirente.

Per poter realizzare la personalizzazione della grafica l'immagine deve essere inviata con una risoluzione superiore a 300 dpi e di dimensione possibilmente superiore a 3000 pixel al lato maggiore.

L'utilizzo di una immagine personalizzata può essere ad uso privato o commerciale, in entrambi i casi dovrà tutelare l'azienda Momenti da copyright e/o manleva da responsabilità civili o penali. Si consiglia di contattare l'azienda per qualsiasi tipo di informazione.

/ The chromatic tones of the images / graphics, displayed on the monitor, website, brochure and / or in this catalog, differ from the images printed on the finished product, since the printing provides different results depending on the product and the supporting raw material.

Consequently, the Customer, by confirming the order, accepts these tolerances and these characteristics, which cannot therefore be the subject of any dispute.

Customized graphic design creation

All graphics can be purchased in their standard version as viewed on this catalogue, or adapted to the customer's needs through customization.

Graphics can also be created using one or more images provided by the customer, or processed by our Momenti Lab following the needs of the purchaser.

In order to customize the graphics, the image must be sent with a resolution higher than 300 dpi and possibly with a dimension higher than 3000 pixels on the larger side.

The use of a personalized image can be for private or commercial use, in both cases it must protect the Momenti company from copyright and/or release from civil or criminal liability. It is advisable to contact the company for any type of information.



*Esempio di immagine cliente in formato vettoriale
/ Example of customer image in vector format*



*Esempio di fotografia cliente in formato verticale
/ Example of customer photograph in vertical format*



*Esempio di immagine cliente in formato vettoriale
/ Example of customer image in vector format*



*Esempio di fotografia cliente in formato orizzontale
/ Example of customer photograph in landscape format*

Designers

Marco Anconelli

Archivio Spadacini

Laurent Baheux

Mateo Bories

Matteo Bosi

Tommaso "iomso" Cavallini

Alessandro Corina

Rosso Emerald Crimson (Rosso Artist)

Enrico De Luigi

Shirin Donia

Ivana Dostalova

Claudio Fabbri Ferrini

Rie Froehlich

Michela Gioachin

Marco Grassi

Honet

Darren Hopes

Michelino Iorizzo

Giulio Iurissevich

Ashima Kumar

Samuele "Man-Zú" Manzoni

Luis Martin

Riccardo Morvillo

Peeter Must

Riccardo Raul Papavero

Michele Pau

Ludmilla Radchenko

Carlo Ravaioli

Reve+ (Beltrami Matteo)

Mr. Sados

SNYDER

Jessica Incerti Telani

Daniela Tzvetkova

Momenti Lab



Alexander e Matteo Bagnai
Founders, Italy



MOMENTI Lab
Graphic designers, Italy



Alessandro Corina
Designer, Italy



Rosso Artist
Interior designer, Italy



Enrico De Luigi
Photographer, Italy



Marco Anconelli
Photographer, Italy



Archivio Spadacini
Designers, Italy



Laurent Baheux
Photographer, France



Shirin Donia
Painter, Germany



Ivana Dostalova
Photographer, Czech Republic



Claudio Fabbri Ferrini
Graphic designer, Italy



Mateo Bories
Graffiti artist, Canada



Matteo Bosi
Photographer & designer, Italy



Tommaso Cavallini
Interior designer, Italy



Rie Froehlich
Painter, USA



Michela Gioachin
Painter, Italy



Marco Grassi
Painter, Italy



HONET
Graffiti artist, France



Darren Hopes
Illustrator, UK



Michelino Iorizzo
Painter, Italy



Riccardo Raul Papavero
Painter, Italy



Michele Pau
Painter, Italy



Ludmilla Radchenko
Artist, Italy



Giulio Iurissevich
Illustrator, Italy



Ashima Kumar
Illustrator, India



Samuele "Manzù" Manzoni
Photographer, Italy



Carlo Ravaioli
Painter, Italy



Reve +
Graffiti artist, Italy



Mr. Sados
Graphic designer, Ukraine



Luis Martin
Art Engineer, United States



Riccardo Morvillo
Digital artist, Italy



Peeter Must
Painter, Estonia



SNYDER
Designer and Architect, Germany



Jessica Incerti Telani
Digital artist, Italy



Daniela Tzvetkova
Illustrator, Italy

