

Lavamani Handbasins



Indice

Summary

04	Overview lavamani Handbasins overview
06	<u>P'tit</u>
16	<u>Mignon</u>
26	<u>Box</u>
36	<u>Unico</u>
56	Informazioni tecniche Technical informations
58	<u>Le caratteristiche del Corian® Corian® characteristics</u>

Uno degli argomenti sfidanti della progettazione è creare elementi che si inseriscano perfettamente nello spazio rispondendo a criteri di flessibilità e di funzionalità. Un bisogno che diventa addirittura cruciale quando si parla degli ambienti più piccoli della casa.

Dalla comprensione di questa necessità nasce una gamma completa di lavamani frutto della preziosa collaborazione tra Rexa e Monica Graffeo.

Oggetti che, nonostante le loro dimensioni ridotte, sono stati progettati per soddisfare le esigenze estetiche e funzionali degli spazi bagno più compatti, grazie alle linee raffinate ed essenziali e al mondo di accessori correlati.

Creating elements that fit perfectly into the space meeting the needs of flexibility and functionality is one of the challenges of design. A requirement that becomes even crucial when we talk about the smallest rooms of the house. A complete range of washbasins resulting from the valuable collaboration between Rexa and Monica Graffeo was born from a deep understanding of this necessity. Objects that, despite their small sizes, have been designed to satisfy the aesthetic and functional needs of the most compact bathrooms, thanks to the elegant and essential lines and world of related accessories.

L'un des sujets de défi de la conception est de créer des éléments qui s'intègrent parfaitement dans l'espace en répondant à des critères de flexibilité et de fonctionnalité. Un besoin qui devient même crucial quand on parle des environnements les plus petits de la maison. De la compréhension de ce besoin naît une gamme complète de lave-mains fruit de la précieuse collaboration entre Rexa et Monica Graffeo. Des objets qui, malgré leurs petites dimensions, ont été conçus pour répondre aux exigences esthétiques et fonctionnelles des espaces de salle de bains plus compacts, grâce aux lignes épurées et essentielles et au monde des accessoires associés.

Eines der schwierigsten Themen des Designs ist es, Elemente zu schaffen, die sich perfekt in den Raum einfügen und erfüllen die Kriterien an die Flexibilität und Funktionalität. Ein Bedürfnis, das zum entscheidend, wenn es um die kleinsten Räume des Hauses geht. Aus dem Verständnis für dieses Bedürfnis erwächst ein Palette von Handwaschbecken, das Ergebnis der Zusammenarbeit zwischen Rexa und Monica Graffeo. Objekte die, trotz ihrer geringen Größe, konzipiert sind, so dass sie den ästhetischen und funktionalen Anforderungen der kompaktesten Badezimmer dank ihrer raffinierten und wesentlichen Linien und der Welt des verwandten Zubehörs befriedigen.

Uno de los temas desafiantes del diseño es crear elementos que encajen perfectamente en el espacio cumpliendo con los criterios de flexibilidad y funcionalidad. Una necesidad que se vuelve incluso crucial cuando se habla de los ambientes más pequeños de la casa. De la comprensión de esta necesidad nace una gama

completa de lavamanos fruto de la valiosa colaboración entre Rexa y Monica Graffeo. Objetos que, a pesar de su pequeño tamaño, han sido diseñados para satisfacer las exigencias estéticas y funcionales de los espacios de baño más compactos, gracias a las líneas refinadas y esenciales y al mundo de los accesorios relacionados.

Overview



P'tit
P 06



Mignon
P 16



Box
P 26



Unico
P 36

P'tit

design by Monica Graffeo

Lavamani P'tit 45x22x28h cm in Korakril™ Grigio Scuro. Miscelatore Mae a parete in Black Luxury. Appendino in Faggio Naturale. Specchiera Hammam Ø40 cm in Corian® Deep Nocturne. Lampada Circle nera a parete.

P'tit hand basin 45x22x28h cm in Korakril™ Grigio Scuro. Mae wall mounted mixer in Black Luxury. Hanger in Natural Beech. Hammam mirror Ø40 cm in Corian® Deep Nocturne. Circle black wall lamp.

Lave-mains P'tit 45x22x28h cm en Korakril™ Grigio Scuro. Mitigeur Mae mural en Black Luxury. Crochet en bois naturel. Miroir Hammam 40 cm en Corian® Deep Nocturne. Lampe Circle noire sur le mur.

P'tit Handwaschbecken 45x22x28h cm in Korakril™ Grigio Scuro. Mae Wandarmatur aus Black Luxury. Haken aus Buche Natur. Hammam Spiegel Ø40 cm aus Corian® Deep Nocturne. Schwarze Circle Wandleuchte.

Lavamano P'tit 45x22x28h cm en Korakril™ Grigio Scuro. Mezclador Mae de pared en Black Luxury. Percha en Haya Natural. Espejo Hammam Ø40 cm en Corian® Deep Nocturne. Lámpara Circle negra en la pared.

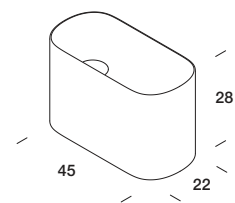

P'tit

design by Monica Graffeo

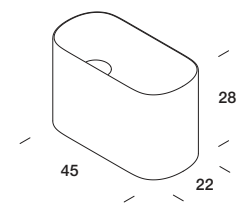

Lavamani

P'tit

8



9

P'tit

Handbasins



Lavamani P'tit in Korakril™ Blend 45x22x28h cm. Misceatore Virgola in acciaio Aisi 316l satinato. Mensola e appendino in faggio naturale. Specchiera Filolucido 48x60h cm. Lampada Bool a sospensione.

P'tit hand basin in Korakril™ Blend 45x22x28h cm. Virgola mixer in satin-finish AISI 316l steel. Shelf and hanger in Natural Beech. Filolucido mirror 48x60h cm. Bool suspension lamp.

Lave-mains P'tit 45x22x28h cm en Korakril™ Blend 45x22x28h cm. Mitigeur Virgola en acier AISI 316l satiné. Étagère et crochet en bois naturele. Miroir Filolucido 48x60h cm. Lampe Bool à suspension.

P'tit Handwaschbecken aus Korakril™ Blend 45x22x28h cm. Virgola-Mischer aus gebürsteter Edelstahl AISI 316l Regal und Haken aus Buche Natur. Filolucido-Spiegel 48x60h cm. Bool Pendelleuchte.

Lavamano P'tit en Korakril™ Blend 45x22x28h cm. Mezclador Virgola de acero AISI 316l satinado. Estante y percha en Haya Natural. Espejo Filolucido 48x60h cm. Lámpara Bool a suspensión.



Mensola
Shelf



Mensola
Shelf



Appendino
Hook

P'tit



P'tit

Overview

P'tit



L 45 P 22 H 28

Finiture | Finishes

Korakril™ Blend (Lavabo | Washbasin)



Ice
White

Korakril™ (Lavabo | Washbasin)



Grigio
Scuro

Grigio

Sabbia

Tortora

Miscelatori abbinabili | Combinable mixers

Mae



Mae Contract



Drop



Dot



Virgola



Mignon

design by Monica Graffeo

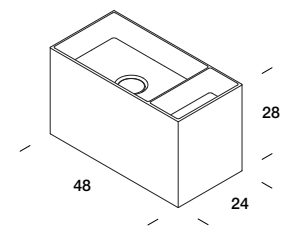



Lavamani Mignon con vaschetta laterale in Korakril™ Blend Ice White 48x24x28h cm. Portasalviette in lamiera bianca opaca 24x10x8h cm. Miscelatore Mae a parete in Acciaio AISI 316I Satinato. Specchiera Filolucido rotonda Ø40 cm e lampada Circle bianca a parete.

Mignon handbasin with side tray in Korakril™ Blend Ice White 48x24x28h cm. Towel rail in metal lacquered white matt 24x10x8h cm. Mae wall-mounted mixer in satin-finish AISI 316I stainless steel. Filolucido round mirror Ø40 cm and Circle white wall lamp.

Lave-mains Mignon avec bac latéral en Korakril™ Blend Ice White 48x24x28h cm. Porte-serviettes en métal blanc mat 24x10x8h cm. Mitigeur Mae mural en acier AISI 316I satiné. Miroir Filolucido ronde diam. 40 cm et lampe Circle blanc au mur.

Mignon Handwaschbecken mit Seitenregal aus Korakril™ Blend Ice White 48x24x28h cm. Handtuchhalter aus Blech Weiß Matt lackierte 24x10x8h cm. Mae Wandarmatur aus gebürsteter Edelstahl AISI 316I. Filolucido runder Spiegel Ø40 cm und weiße Circle Wandleuchte.

Lavamano Mignon con bandeja lateral en Korakril™ Blend Ice White 48x24x28h cm. Toallero en chapa blanca mate 24x10x8h cm. Mezclador Mae de pared en Acero AISI 316I satinado. Espejo Filolucido redondo Ø40 cm y lámpara Circle blanca de pared.

Mignon

design by Monica Graffeo

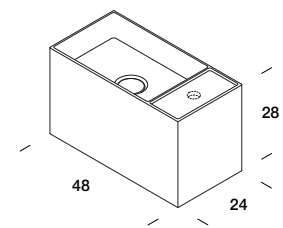

Lavamani

Mignon

20



21

Mignon

Handbasins

Lavamani Mignon con mensola laterale in Korakril™ Grigio Scuro 48x24x28h cm. Portasalviette e mensola ctenitiva in lamiera nera opaca 24x10x8h cm. Rubinetto da piano monoacqua Virgola in Black Luxury.

Mignon handbasin with side shelf in Korakril™ Grigio Scuro 48x24x28h cm. Towel rail and storage shelf in metal matt lacquer 24x10x8h cm. Virgola single-water countertop faucet in Black Luxury.

Lave-mains Mignon avec étagère latérale en Korakril™. Grigio Scuro 48x24x28h cm. Porte-serviettes et étagère de rangement en métal noir mat 24x10x8h cm. Robinet mono-eau Virgola en finition Black Luxury.

Mignon Handwaschbecken mit Seitenregal aus Korakril™ Grigio Scuro 48x24x28h cm. Handtuchhalter und Regal aus Blech Schwarz matt lackierte 24x10x8h cm. Virgola Wasserhahn Mono-wasser auf Deck aus Black Luxury.

Lavamano Mignon con estante lateral en Korakril™ Grigio Scuro 48x24x28h cm. Toallero y estante en chapa negra mate 24x10x8h cm. Grifo de plano mono-agua Virgola en Black Luxury



Mignon



Con mensola laterale
With lateral shelf



Con vaschetta laterale
With side tray

Overview

sospeso
wall hung

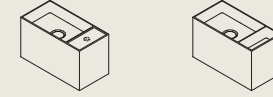

L 48 P 24 H 28

Finiture | Finishes

Korakril™ Blend (Lavabo | Washbasin)



Ice
White

Korakril™ (Lavabo | Washbasin)



Grigio
Scuro

Grigio

Sabbia

Tortora

Miscelatori abbinabili | Combinable mixers

Mae



Mae Contract



Drop



Dot



Virgola



Box

design by Monica Graffeo

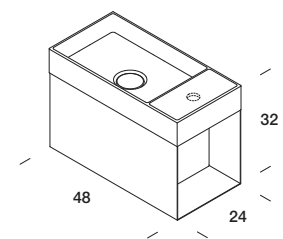

Lavamani

Box

26



27

Box

Handbasins



Lavamani Box 48x24x32h cm con lavabo e mensola laterale in Korakril™ Grigio e base con vano a giorno in lamiera verniciata nera opaca. Miscelatore Mae a parete in Acciaio Aisi 316l Satinato. Portasalviette e mensola contenitiva a parete in lamiera verniciata nera opaca 24x10x8h cm. Specchiera Filolucido e lampada Spin.

Box hand basin 48x24x32h cm with washbasin and side shelf in Korakril™ Grigio and base with open unit in matt black. Mae wall-mounted mixer in satin-finish AISI 316l steel. Towel rail and storage shelf wall-mounted in matt black painted sheet 24x10x8h cm. Filolucido mirror and Spin lamp.

Lave-mains Box 48x24x32h cm avec lavabo et étagère latérale en Korakril™ Grigio et élément ouvert en métal peinte noire mat. Mitigeur mural Mae en acier AISI 316l satiné. Porte-serviettes et étagère de rangement murale en métal peinte noire mat 24x10x8h cm. Miroir Filolucido et lampe Spin.

Box Handwaschbecken 48x24x32h cm mit Waschbecken und Seitenregal aus Korakril™ Grigio und Unterschrank mit offenem Fach aus mattschwarz lackiertem Blech. Mae Wandarmatur aus gebürsteter Stahl AISI 316l. Handtuchhalter und Wandhalterung aus Blech schwarz lackiert 24x10x8h cm. Filolucido Spiegel und Spin Lampe.

Lavamano Box 48x24x32h cm con lavabo y estante lateral en Korakril™ Grigio y base con elemento abierto en chapa pintada negro mate. Mezclador Mae de pared en Acero AISI 316l satinado. Toallero y estante de pared de chapa pintada negro mate 24x10x8h cm. Espejo Filolucido y lámpara Spin.

Box

design by Monica Graffeo

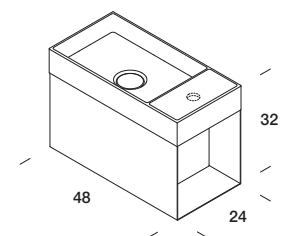

Lavamani

Box

30



Lavamani Box 48x24x32h cm con top e mensola laterale in Korakriil™ Blend Ice White e base con vano a giorno in lamiera verniciata nera opaca. Rubinetto da piano monoacqua Virgola in Black Luxury. Mensola contenitiva a parete in lamiera verniciata nera opaca 24x10x8h cm.

Box hand basin 48x24x32h cm with top and side shelf in Korakriil™ Blend Ice White and base with open unit in matt black varnished sheet metal. Virgola single-water countertop faucet in Black Luxury. Wall-mounted storage shelf in matt black varnished sheet metal 24x10x8h cm.

Lave-mains Box 48x24x32h cm avec plan et étagère latérale en Korakriil Blend Ice White et base avec élément ouvert en métal peinte noire mat. Mitigeur mono-eau Virgola en Black Luxury. Étagère de rangement murale en métal peinte noir mat 24x10x8h cm.

Box Handwaschbecken 48x24x32h cm mit Korakriil™ Blend Ice White mit Unterschrank mit Offenes Element. Virgola Wasserhahn Mono-wasser auf Deck aus Black Luxury Wandablage aus Blech Schwarz Matt lackiertes Blech 24x10x8h cm.

Lavamano Box 48x24x32h cm con encimera y estante lateral en Korakriil™ Blend Ice White y base con elemento abierto de chapa pintada negro mate. Grifo de piso monoagua Virgola en Black Luxury. Estante de pared de chapa pintada negro mate 24x10x8h cm.



Box



Con mensola e vano a giorno laterale
With lateral shelf and open element

Overview

sospeso
wall hung

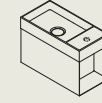

L 48 P 24 H 32

Finiture | Finishes

Korakril™ Blend (Lavabo | Washbasin)



Ice
White

Korakril™ (Lavabo | Washbasin)



Grigio
Scuro



Grigio



Sabbia



Tortora

Lamiera verniciata opaca | Matt painted metal (Base | Unit)



Bianco



Nero

+
Laccati Rexa Design |
Rexa Design lacquered

Miscelatori abbinabili | Combinable mixers

Mae



Mae Contract



Drop



Dot



Virgola



Unico

design by Rexa Design studio

Lavamani Unico in Corian®
Carbon Aggregate 150x24x16h cm.
Doppio rubinetto da piano
monoacqua Virgola in Black Luxury.
Lampade Circle nere a parete.

Unico handbasin in Corian®
Carbon Aggregate 150x24x16h cm.
Virgola double single-water
countertop faucet in Black Luxury.
Circle black wall lamps.

Lave-mains Unico en Corian®
Carbon Aggregate 150x24x16h cm.
Double mitigeur mono-eau Virgola
en Black Luxury. Lampes Circle
noires au mur.

Unico Handwaschbecken aus
Corian® Carbon Aggregate
150x24x16h cm. Virgola
Wasserhahn Mono-wasser auf
Deck aus Black Luxury. Schwarze
Circle Wandlampen.

Lavamano Unico en Corian®
Carbon Aggregate 150x24x16h cm.
Doble grifo de piso monoagua
Virgola en Black Luxury. Lámparas
Circle negras en la pared.

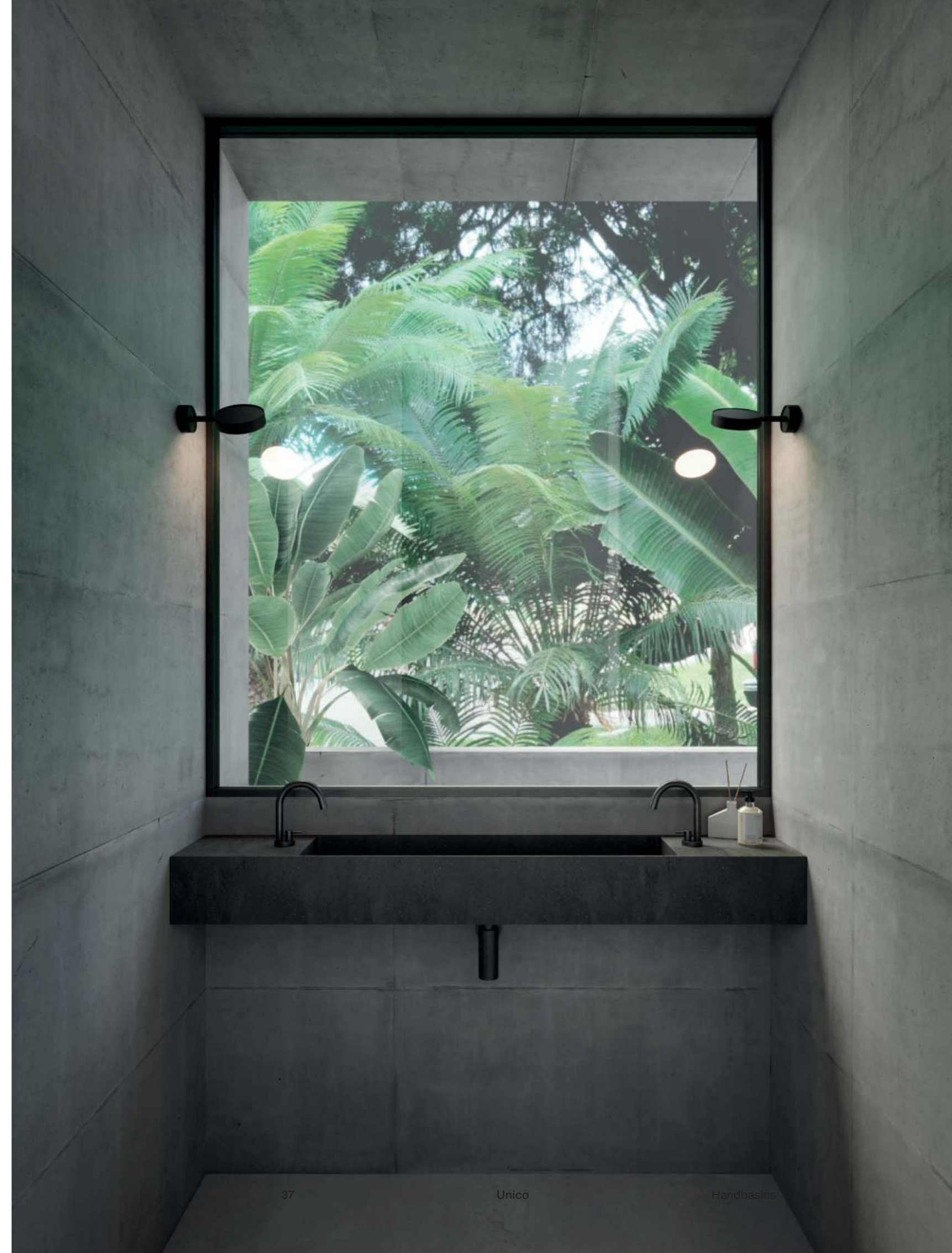
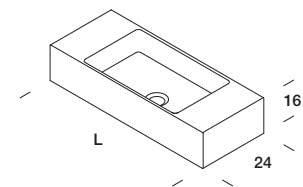



Unico

design by Rexa Design studio

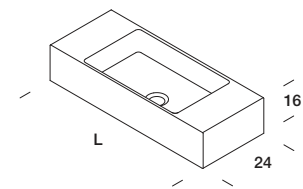

Lavamani

Unico

40



Unico

Handbasins



Lavamani Unico in Corian® Glacier White 100x24x16h cm. Miselatore Mae da piano in Acciaio Aisi 316I Satinato. Lampada Arm.2 in vetro bianco. Specchiera Filolucido 100x48h cm.

Unico handbasin in Corian® Glacier White 100x24x16h cm. Mae countertop mixer in satin-finish AISI 316I steel. Arm.2 lamp in white glass. Filolucido mirror 100x48h cm.

Lave-mains Unico en Corian® Glacier White 100x24x16h cm. Mitigeur Mae en acier AISI 316I satiné. Lampe Arm.2 en verre blanc. Miroir Filolucido 100x48h cm.

Unico Handwaschbecken aus Corian® Glacier White 100x24x16h cm. Mae Mischer auf Deck aus gebürsteter Edelstahl AISI 316I. Arm.2 Lampe in weißem Glas. Filolucido Spiegel 100x48h cm.

Lavamani Unico en Corian® Glacier White 100x24x16h cm. Mezclador Mae de encimera en Acero AISI 316I satinado. Lámpara Arm.2 en vidrio blanco. Espejo Filolucido 100x48h cm.

Unico

design by Rexa Design studio

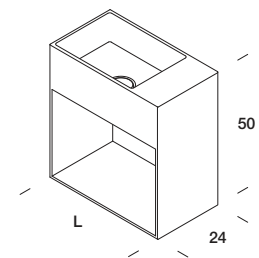

Lavamani

Unico

44

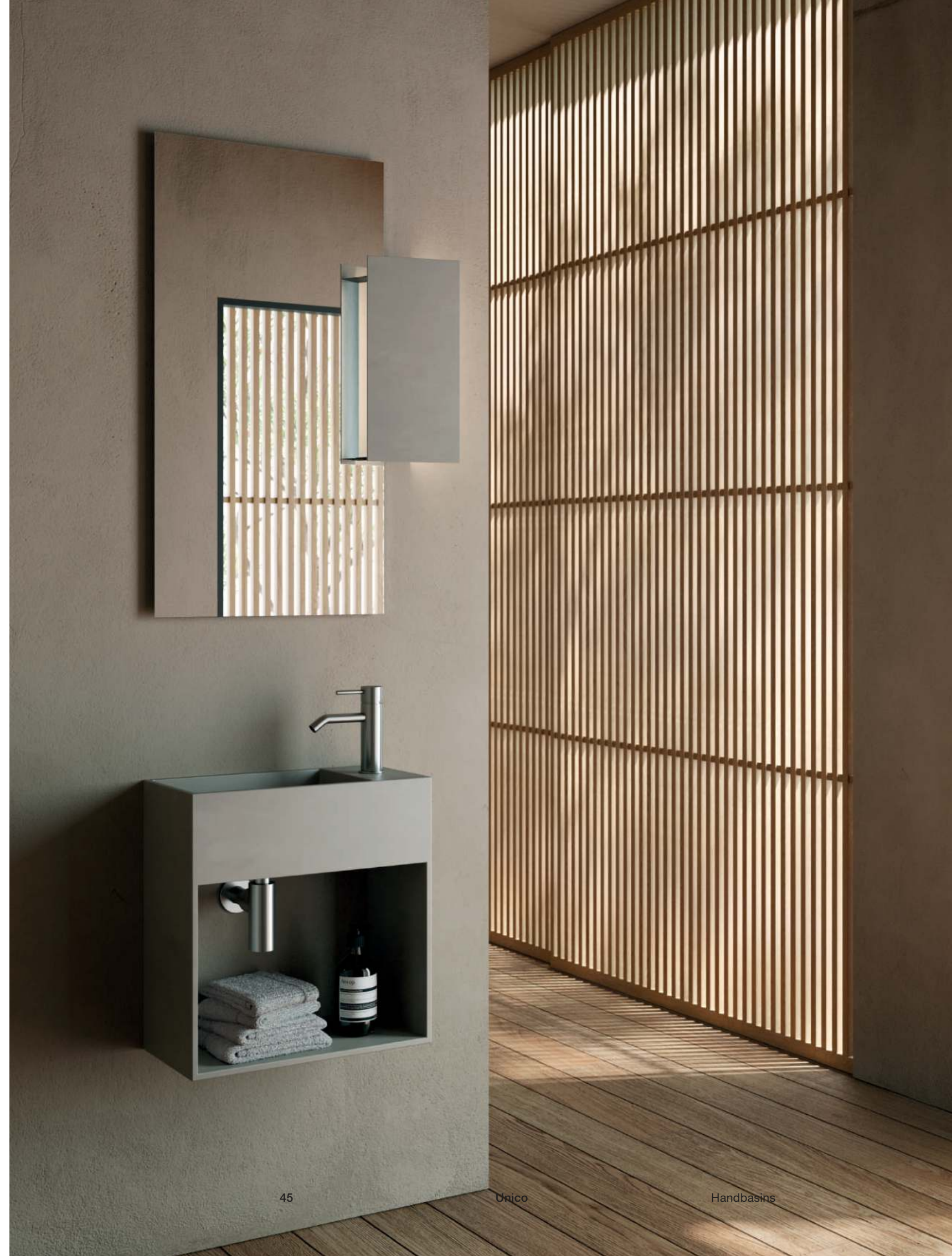

45

Unico

Handbasins



Lavamani Unico con vano a giorno
48x24x50 cm in Corian® Neutral
Concrete. Miscelatore Mae da
piano in Acciaio Aisi 316l Satinato.
Specchiera Filolucido 48x70h cm.
Lampada Spin 20x40h cm in
Corian® Neutral Concrete.

Unico hand basin with open unit
48x24x50 cm in Corian® Neutral
Concrete. Mae countertop mixer
in satin-finish AISI 316l steel.
Filolucido mirror 48x70h cm.
Spin lamp 20x40h cm in Corian®
Neutral Concrete.

Lave-mains Unico avec élément
ouvert 48x24x50 cm en Corian®
Neutral Concrete. Mitigeur Mae
sur plan en acier AISI 316l satiné.
Miroir Filolucido 48x70h cm.
Lampe Spin 20x40h cm en Corian®
Neutral Concrete.

Unico Handwaschbecken mit
offenem Fach 48x24x50 cm aus
Corian® Neutral Concrete.
Mae Mischer auf Deck aus
gebürsteter Stahl AISI 316l.
Filolucido Spiegel 48x70h cm.
Spin Lampe 20x40h cm aus Corian®
Neutral Concrete.

Lavamano Unico con elemento
abierto 48x24x50 cm en Corian®
Neutral Concrete. Mezclador
Mae de encimera en Acero
AISI 316l satinado.
Espejo Filolucido 48x70h cm.
Lámpara Spin 20x40h cm in Corian®
Neutral Concrete.

Unico

design by Rexa Design studio

Lavamani Unico con ante
60x24x50h cm in Corian® Dune
Prima. Miscelatore Dot in Acciaio
Aisi 316l Satinato. Appendini Moon
in Corian® Deep Nocturne Ø4 cm.

Unico hand basin with doors
60x24x50h cm in Corian® Dune
Prima. Dot mixer in satin-finish
Steel AISI 316l. Moon hooks in
Corian® Deep Nocturne Ø4 cm.

Lave-mains Unico avec portes
60x24x50h cm en Corian® Dune
Prima. Mitigeur Dot en Acier AISI
316l satiné. Crochet Moon en
Corian® Deep Nocturne diam. 4 cm.

Unico Handwaschbecken mit
Türen 60x24x50h cm aus Corian®
Dune Prima. Dot Mischer aus
gebürsteter Edelstahl AISI 316l.
Moon Haken aus Corian® Deep
Nocturne Ø4 cm.

Lavamano Unico con puertas
batientes 60x24x50h cm en
Corian® Dune Prima. Mezclador
Dot en Acero AISI 316l satinado.
Perchas Moon Corian® Deep
Nocturne Ø4 cm.

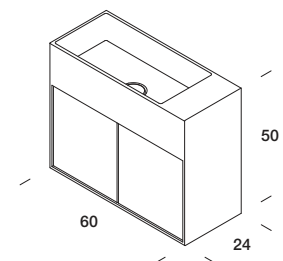



A. Lavamani Unico in Corian® Glacier White con anta in Rovere.
 B. Lavamani Unico in Corian® Glacier White con anta in Noce Canaletto.
 C. Lavamani in Corian® Glacier White con anta in Eucalipto.

A. Unico handbasin in Corian® Glacier White with Oak door.
 B. Unico hand basin in Corian® Glacier White with door in Canaletto Walnut.
 C. Handbasin in Corian® Glacier White with door in Eucalyptus.

A. Lave-mains Unico en Corian® Glacier White avec porte en Rovere.
 B. Lave-mains Unique en Corian® Glacier White avec porte en noyer Canaletto.
 C. Lave-mains en Corian® Glacier White avec porte en Eucalyptus.

A. Unico Handwaschbecken aus Corian® Glacier White mit Tür aus Eiche.
 B. Unico Handwaschbecken aus Corian® Glacier White mit Tür aus Canaletto-Nussbaum.
 C. Handwaschbecken aus Corian® Glacier White mit Tür aus Eukalyptus.

A. Lavamano Unico en Corian® Glacier White con puerta de roble.
 B. Lavamano Unico en Corian® Glacier White con puerta de Nogal Canaletto.
 C. Lavamano en Corian® Glacier White con puerta de Eucalipto.



Unico



Unico



Unico con vano
Unico with open element



Unico con ante
Unico with doors

Overview

Unico

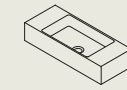

L 60-70-80-90-100-150 P 24 H 16

Unico con vano / ante | Unico with open element / doors

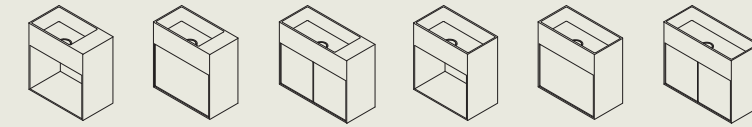

L 48-60 P 24 H 50

Finiture | Finishes

Corian® (Unico)



Abbinamenti | Combinations (Unico con ante | Unico with doors)



Miscelatori abbinabili | Combinable mixers

Mae



Mae Contract



Drop



Dot



Virgola





Portasalviette in lamiera
Metal towelrail



Portasalviette in Corian®
Corian® towelrail



Mensola in lamiera
Metal shelf

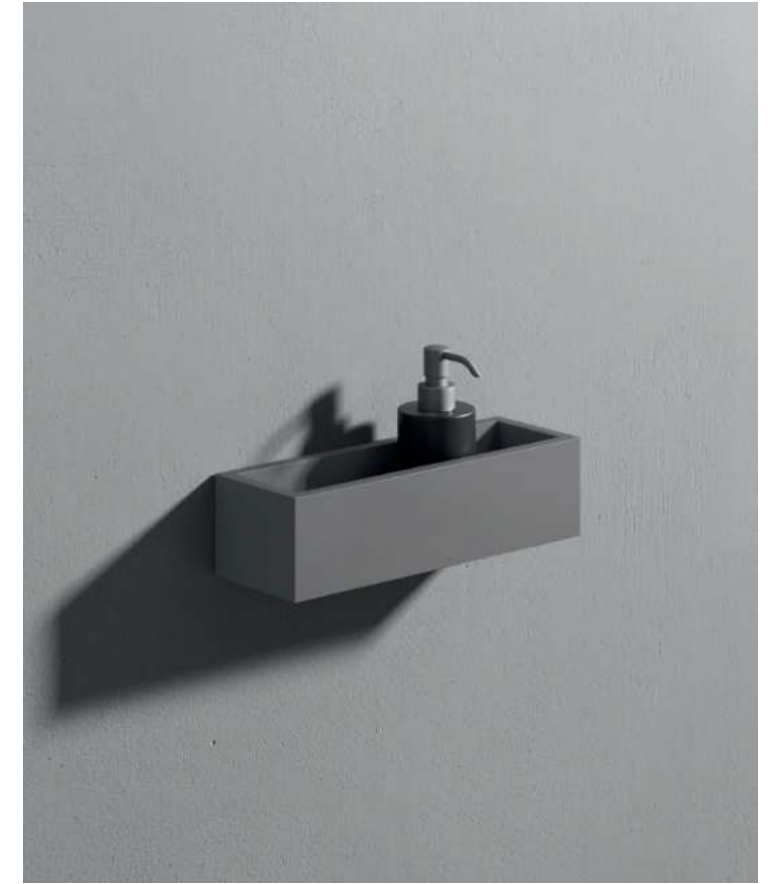

Mensola in Corian®
Corian® shelf

Informazioni tecniche

Technical informations | Informations techniques | Technische Informationen | Información técnica

Caratteristiche del Corian®

Characteristics of Corian® | Caractéristiques du Corian® | Corian® Eigenschaften | Características del Corian®

Esterno e interno lastra | Inside and outside of the plate

Ⓐ Lato superiore
Upper side

Ⓑ Lato inferiore
Lower side

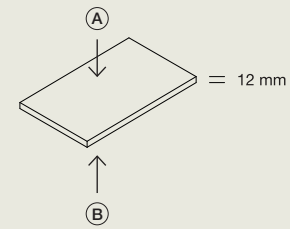

I Corian® sotto riportati presentano delle differenze e discontinuità di venature e texture anche tra il fronte e il retro della lastra.

The Corian® below have differences and discontinuities of veins and textures even between the front and the back of the sheet.

Les Corian® ci-dessous, présentent des différences et des discontinuités de veines et textures également entre le devant et le dos de la plaque.

Die unten aufgeführten Corian® haben Unterschiede und Diskontinuitäten in dem Adern und Texturen auch zwischen der Vorder- und Rückseite des Blattes.

Los Corian® siguientes presentan diferencias y discontinuidades de vetas y texturas también entre el frente y la parte posterior de el panel.

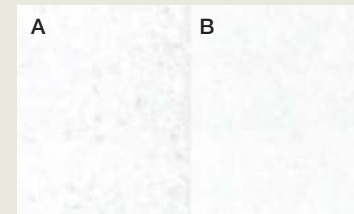
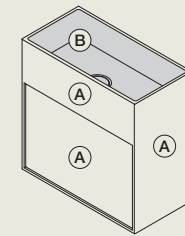
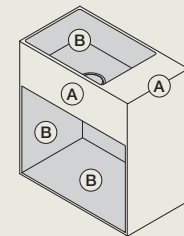
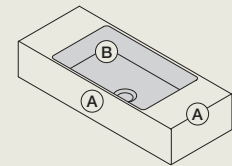

Antarctica

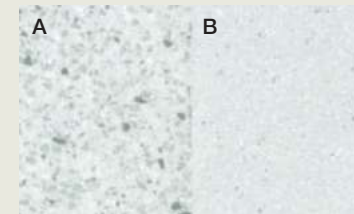

Silver Birch



Artista Canvas

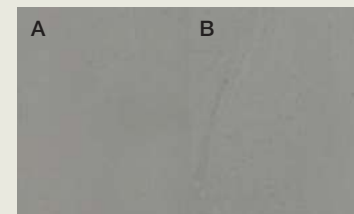

Neutral Concrete

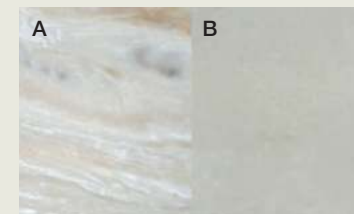

Dune Prima

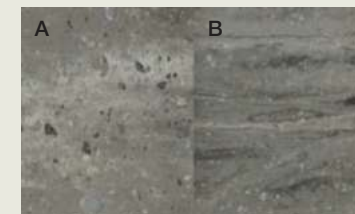

Ash Aggregate

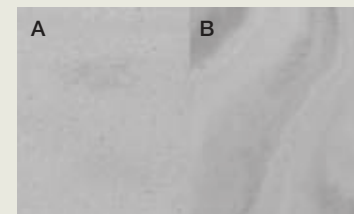

Artista Gray

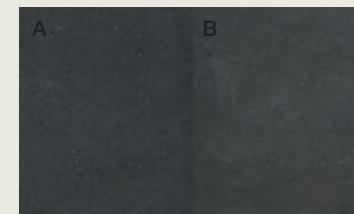

Carbon Concrete

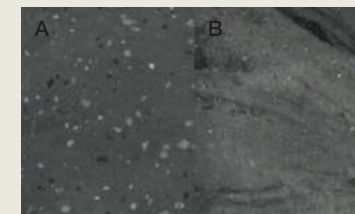

Carbon Aggregate

Raggiatura | Radius

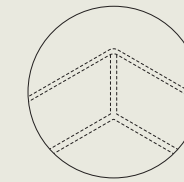

Per la creazione di determinate forme di lavabo viene creata una raggiatura sugli spigoli inserendo un sottile listello di Corian® che verrà successivamente levigato. Sempre a causa della difficile ripetizione precisa di texture e venature spesso si possono notare alcune differenze tra superfici.

For the creation of certain washbasin shapes a radius is created on the edges by inserting a thin strip of Corian® which then will be sanded. Because of the difficult precise repetition of textures and veins, it is often possible to notice some differences between the surfaces.

Pour la création de certaines formes de lavabo est créé un rayonnage sur les arêtes en insérant une petite bande de Corian® qui sera ensuite poncée. En raison de la difficile répétition précise des textures et des veines, sont souvent marquées des différences entre les surfaces.

Für die Schaffung von bestimmten Waschtischformen wird einen Radius an den Kanten erstellt durch Einfügen eines dünnen Streifens aus Corian®, der dann abgeschliffen wird. Wegen der schwierigen präzise Wiederholung von Texturen und Adern sind oft einige Unterschiede zwischen den Oberflächen zu erkennen.

Para la creación de ciertas formas de lavabo, se crea un radiado en las esquinas mediante la inserción de un delgado listón de Corian® que luego se lijará. Debido a la difícil repetición precisa de texturas y vetas, a menudo se pueden notar algunas diferencias entre las superficies.



Antarctica, Silver Birch, Artista Canvas, Neutral Concrete, Dune Prima, Ash Aggregate, Artista Gray, Carbon Concrete, Carbon Aggregate

Dimensioni | Dimensions

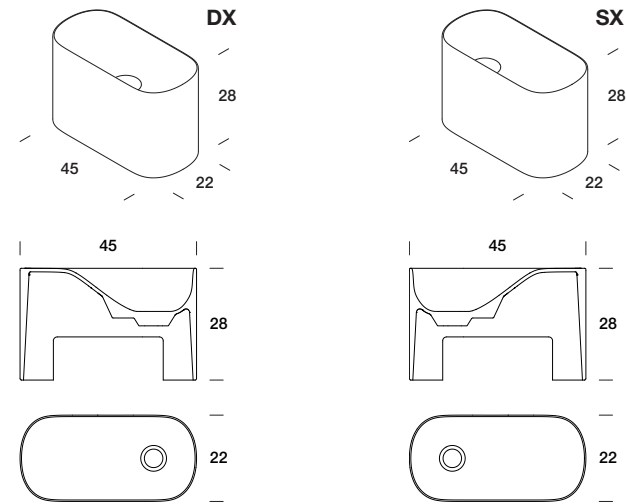

Fissaggi e piletta scarico libero a filo inclusa, sifone escluso | Fixings and free flow drain included; siphon excluded | Fixations et bonde à écoulement libre à fil inclus, siphon non compris | Befestigung und freier Ablauf inklusiv; Siphon ausgeschlossen | Accesorios y desagüe libre incluidos, sifón excluido

Installazione | Installation

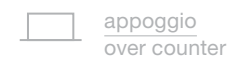

appoggio
over counter

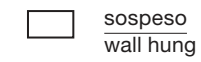

sospeso
wall hung

Rubinetteria | Faucet



a parete
on wall

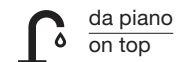

da piano
on top

Scarico | Drain

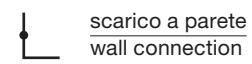

scarico a parete
wall connection

Pesi e volumi | Weight and volume

Kg	Kg	M ³
10,3	15,3	0,07

Korakril™ Blend



Ice White
K31

Korakril™



Grigio Scuro
K05

Grigio
K04

Sabbia
K02

Tortora
K03

P'tit accessories | P'tit accessoires | P'tit Zubehören | P'tit accesorios

Mensola | Shelf

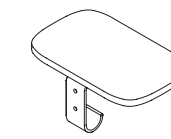

L 18
P 11
H 1,2

Appendino | Hook



L 3
P 5,5
H 6

Korakril™ Blend



Ice White
K31

Legno | Wood (mensola, appendino | shelf, hook)



Faggio naturale

Mignon con mensola laterale

Mignon with lateral shelf | Mignon avec étagère latérale | Mignon mit Seitenregal | Mignon con estante lateral

Dimensioni | Dimensions

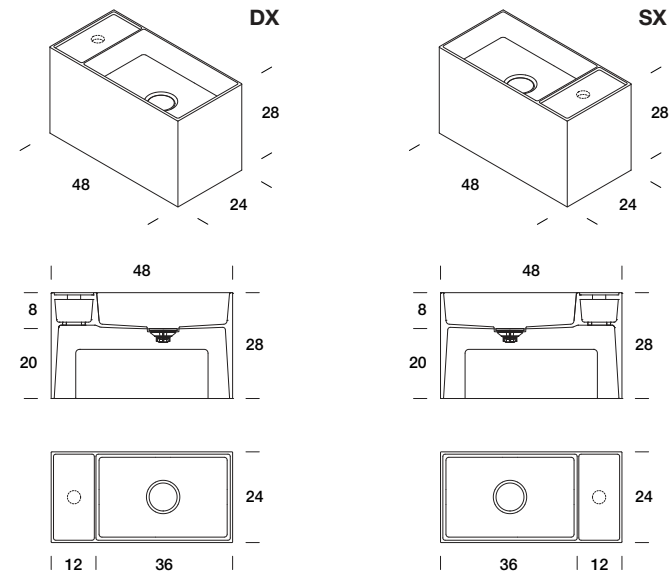



Fissaggi e piletta scarico libero a filo inclusa, sifone escluso | Fixings and free flow drain included; siphon excluded | Fixations et bonde à écoulement libre à fil inclus, siphon non compris | Befestigung und freier Ablauf inklusiv; Siphon ausgeschlossen | Accesorios y desagüe libre incluidos, sifón excluido

Foro rubinetto | Tap hole

COD	MISCELATORE REXA / REXA FAUCET	ALTRO MISCELATORE / OTHER FAUCET
91020101	0	109

Installazione | Installation

 appoggio over counter

 sospeso wall hung

Rubineria | Faucet

 a parete on wall

 da piano on top

Scarico | Drain

 scarico a parete wall connection

Pesi e volumi | Weight and volume

Kg	Kg	M³
12	17	0,09

Korakril™ Blend (lavamani | handbasin)



Ice White K31

Korakril™ (lavamani | handbasin)



Grigio Scuro K05

Grigio K04

Sabbia K02

Tortora K03

Mignon con vaschetta laterale

Mignon with side tray | Mignon avec bac latérale | Mignon mit Seitentablette | Mignon con bandeja lateral

Dimensioni | Dimensions

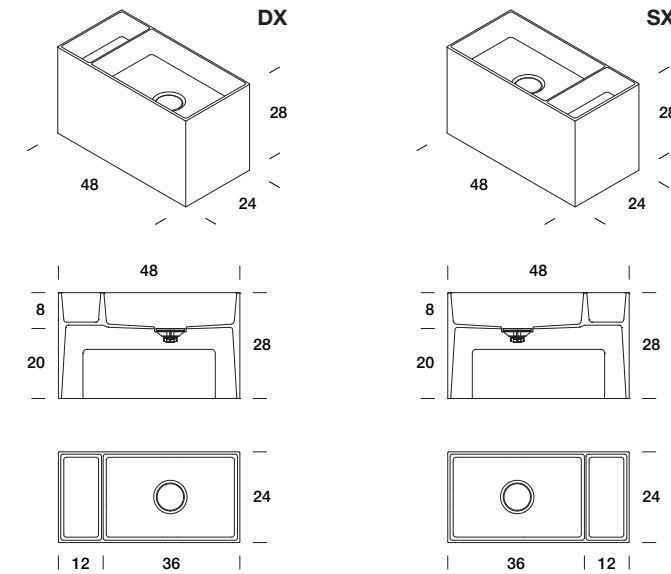



Fissaggi e piletta scarico libero a filo inclusa, sifone escluso | Fixings and free flow drain included; siphon excluded | Fixations et bonde à écoulement libre à fil inclus, siphon non compris | Befestigung und freier Ablauf inklusiv; Siphon ausgeschlossen | Accesorios y desagüe libre incluidos, sifón excluido

Foro rubinetto | Tap hole

COD	MISCELATORE REXA / REXA FAUCET	ALTRO MISCELATORE / OTHER FAUCET
91020101	0	109

Installazione | Installation

 appoggio over counter

 sospeso wall hung

Rubineria | Faucet

 a parete on wall

 da piano on top

Scarico | Drain

 scarico a parete wall connection

Pesi e volumi | Weight and volume

Kg	Kg	M³
12	17	0,09

Korakril™ Blend (lavamani | handbasin)



Ice White K31

Korakril™ (lavamani | handbasin)



Grigio Scuro K05

Grigio K04

Sabbia K02

Tortora K03

Box con mensola e vano a giorno laterale

Box with lateral shelf and open element | Box avec étagère et élément ouvert latéral | Box mit Seiten Regal und Offenes Element | Box con estante y elemento abierto

Dimensioni | Dimensions

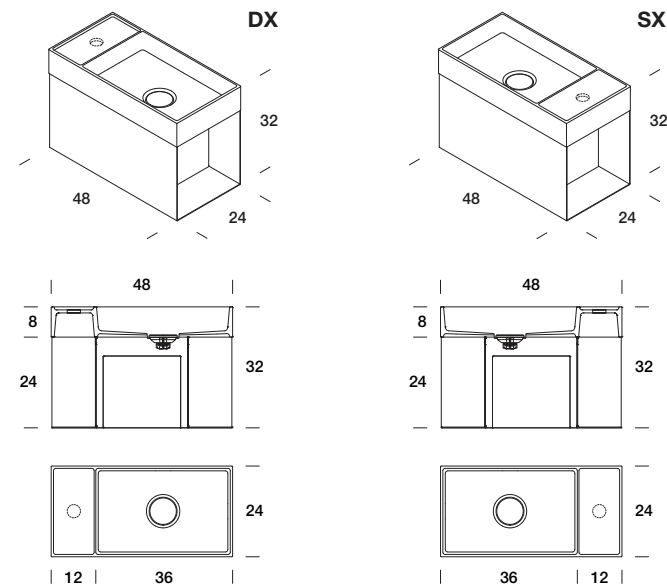

Fissaggi e piletta scarico libero a filo inclusa, sifone escluso | Fixings and free flow drain included; siphon excluded | Fixations et bonde à écoulement libre à fil inclus, siphon non compris | Befestigung und freier Ablauf inklusiv; Siphon ausgeschlossen | Accesorios y desagüe libre incluidos, sifón excluido

Foro rubinetto | Tap hole

COD	MISCELATORE REXA / REXA FAUCET	ALTRO MISCELATORE / OTHER FAUCET
91020101	0	109

Installazione | Installation



Rubineria | Faucet

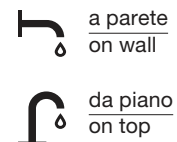

Scarico | Drain

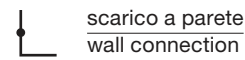

Pesi e volumi | Weight and volume

Kg	Kg	M³
10	15	0,09

Abbinabilità Rexa | Rexa combinations

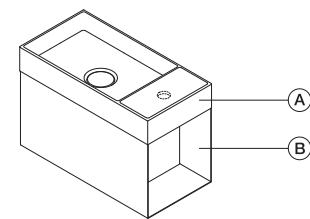

A = lavamani | handbasin
Korakril™ (5 colori | colors)

B = base | unit
Lamiera verniciata opaca |
Matt painted metal
(20 colori | colors)

Korakril™ Blend (lavamani | handbasin)



Ice White
K31

Korakril™ (lavamani | handbasin)



Grigio Scuro
K05



Grigio
K04



Sabbia
K02



Tortora
K03

Lamiera verniciata opaca | Matt painted metal (di serie | di serie)



Bianco
LR1



Nero
LR2

Lamiera verniciata opaca | Matt painted metal (colori su ordinazione | colors on demand)

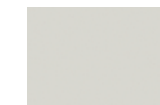

Beige Fresco
LR40



Beige
LR42



Zenzero
LR47



Grigio Luce
LR39



Grafite
LR32

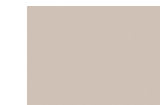

Sabbia
LR33



Fango Luce
LR35



Fango
LR31



Tortora
LR04



Rosa Polvere
LR48



Rosso Cupo
LR37



Rosa Fumo
LR36



Melanzana
LR38



Grigio Muschio
LR45



Grigio Foresta
LR49



Verde Pino
LR46



Azzurro
LR43



Blu Desaturato
LR44

RAL a richiesta +20% | RAL upon request +20% | RAL sur demande +20% | RAL auf Anfrage +20% | RAL a pregunta +20%

Unico

Dimensioni | Dimensions

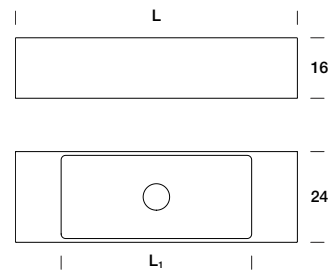
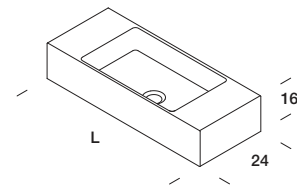

Fissaggi e piletta scarico libero a filo inclusa, sifone escluso | Fixings and free flow drain included; siphon excluded | Fixations et bonde à écoulement libre à fil inclus, siphon non compris | Befestigung und freier Ablauf inklusiv; Siphon ausgeschlossen | Accesorios y desagüe libre incluidos, sifón excluido



Foro rubinetto | Tap hole

COD	MISCELATORE REXA / REXA FAUCET	ALTRO MISCELATORE / OTHER FAUCET
91020101	0	109

Installazione | Installation

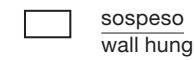
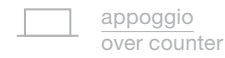

Rubinetteria | Faucet

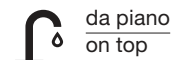

Scarico | Drain

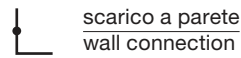

Corian®

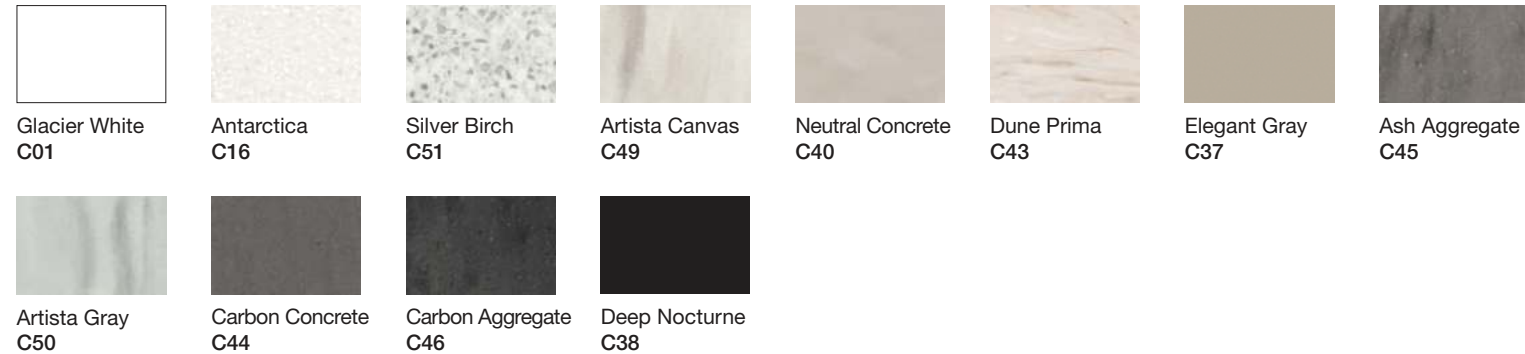

Unico con mensola e vano a giorno

Unico with lateral shelf and open element | Unico avec étagère et élément ouvert | Unico mit Regal und offenes element | Unico con estante y elemento abierto

Dimensioni | Dimensions

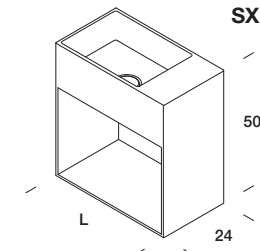
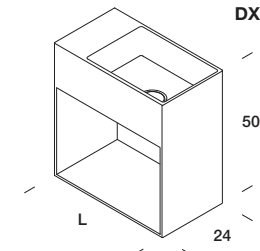

Fissaggi e piletta scarico libero a filo inclusa, sifone escluso | Fixings and free flow drain included; siphon excluded | Fixations et bonde à écoulement libre à fil inclus, siphon non compris | Befestigung und freier Ablauf inklusiv; Siphon ausgeschlossen | Accesorios y desagüe libre incluidos, sifón excluido

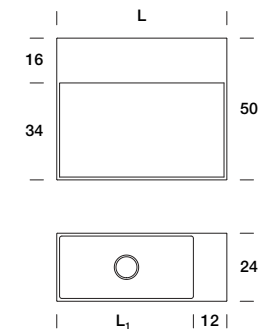
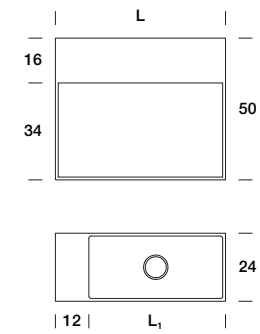

Foro rubinetto | Tap hole

COD	MISCELATORE REXA / REXA FAUCET	ALTRO MISCELATORE / OTHER FAUCET
91020101	0	109

Installazione | Installation

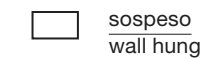
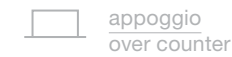

Rubinetteria | Faucet



Scarico | Drain

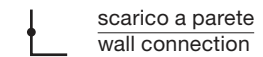

Pesi e volumi | Weight and volume

Kg	Kg	M ³
17	22	0,14

Corian®

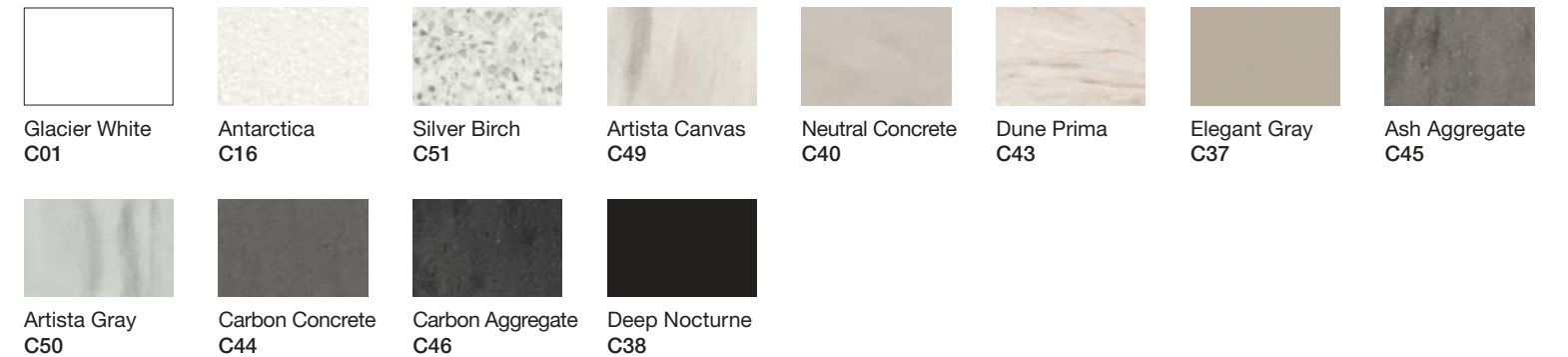

Unico con mensola e anta

Unico with shelf and door | Unico avec étagère et porte | Unico mit Regal und Tür | Unico con estante y puerta

Dimensioni | Dimensions

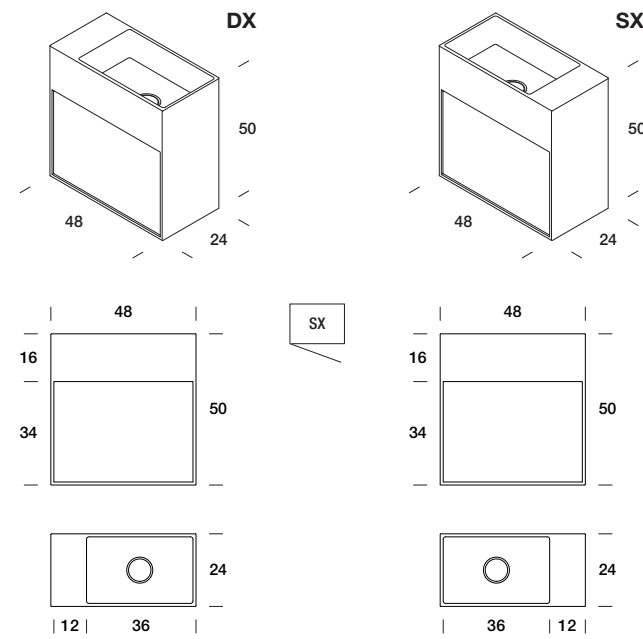

Fissaggi e piletta scarico libero a filo inclusa, sifone escluso | Fixings and free flow drain included; siphon excluded | Fixations et bonde à écoulement libre à fil inclus, siphon non compris | Befestigung und freier Ablauf inklusiv; Siphon ausgeschlossen | Accesorios y desagüe libre incluidos, sifón excluido

Installazione | Installation



Scarico | Drain

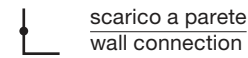

Foro rubinetto | Tap hole

COD	MISCELATORE REXA / REXA FAUCET	ALTRO MISCELATORE / OTHER FAUCET
91020101	0	109

Rubinerteria | Faucet

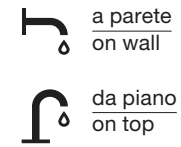

Pesi e volumi | Weight and volume

Kg	Kg	M³
18,5	23,5	0,12

Abbinabilità Rexa | Rexa combinations

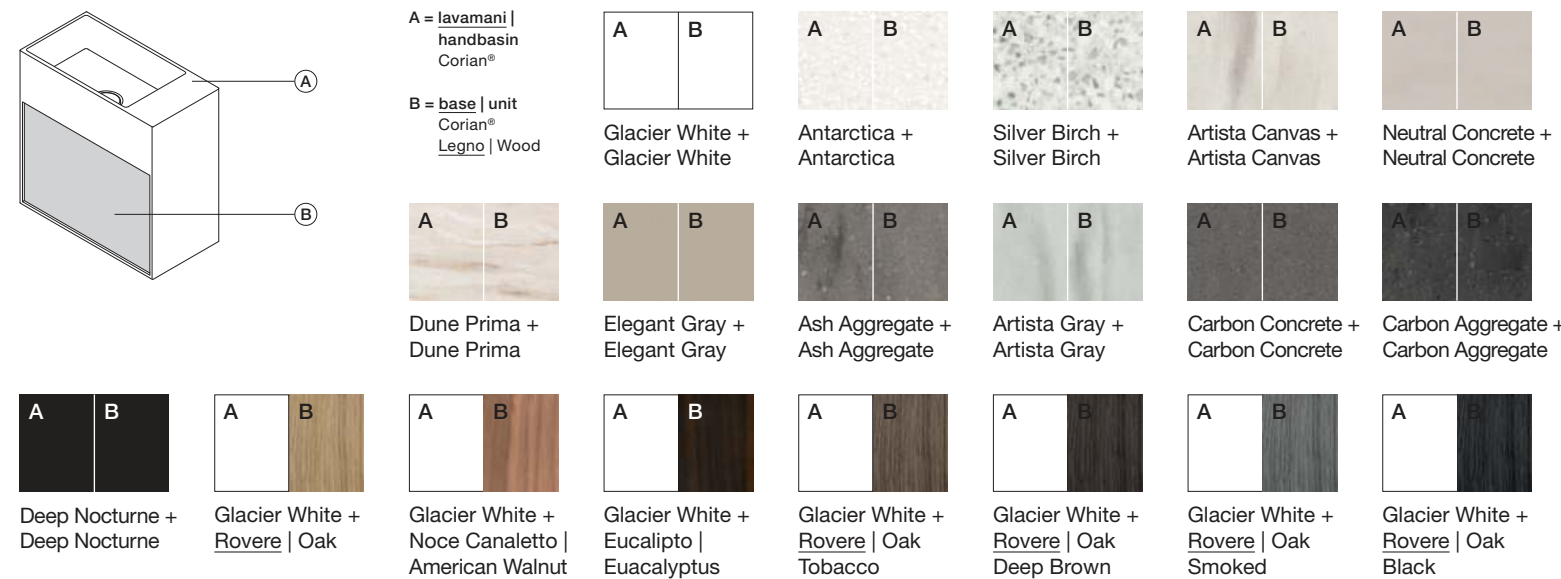

Unico con mensola e doppia anta

Unico with shelf and double door | Unico avec étagère et double porte | Unico mit Regal und Doppeltür | Unico con estante y doble puerta

Dimensioni | Dimensions

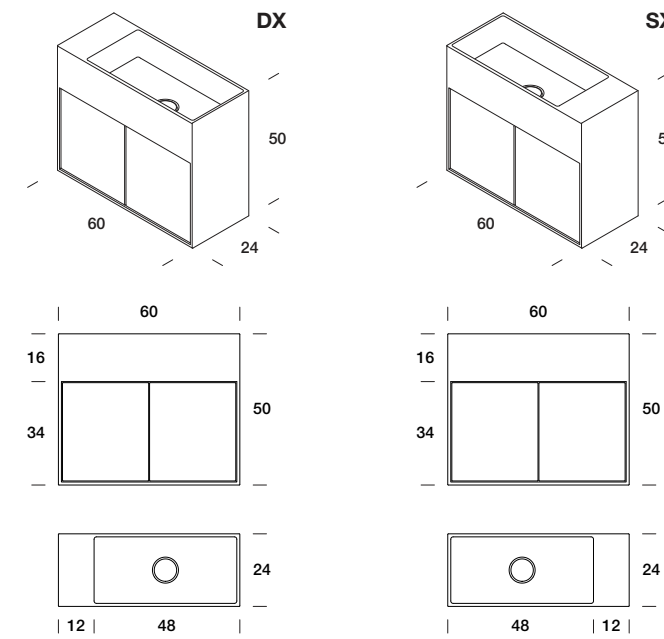

Fissaggi e piletta scarico libero a filo inclusa, sifone escluso | Fixings and free flow drain included; siphon excluded | Fixations et bonde à écoulement libre à fil inclus, siphon non compris | Befestigung und freier Ablauf inklusiv; Siphon ausgeschlossen | Accesorios y desagüe libre incluidos, sifón excluido

Installazione | Installation



Scarico | Drain

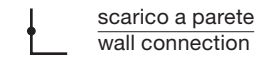

Foro rubinetto | Tap hole

COD	MISCELATORE REXA / REXA FAUCET	ALTRO MISCELATORE / OTHER FAUCET
91020101	0	109

Rubinerteria | Faucet

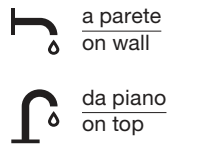

Pesi e volumi | Weight and volume

Kg	Kg	M³
22	27	0,14

Abbinabilità Rexa | Rexa combinations

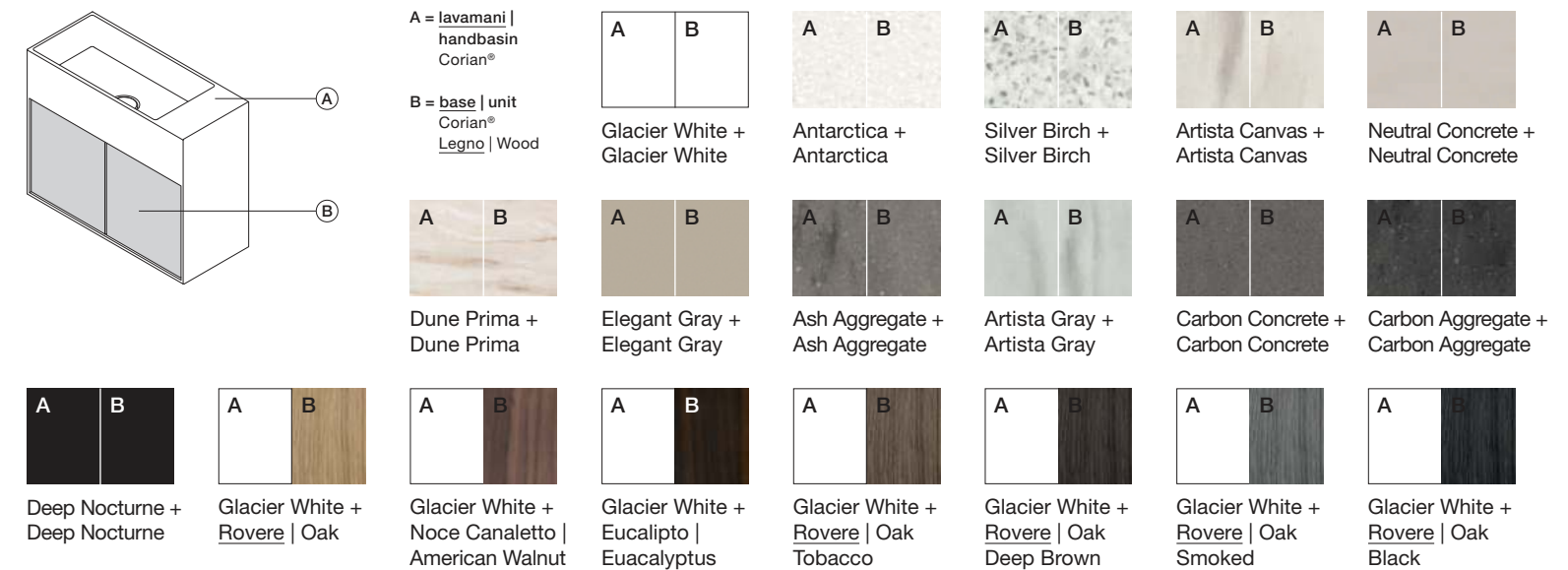

Unico con vano a giorno

Unico with open element | Unico avec élément ouvert | Unico mit Offenes Element | Unico con elemento abierto

Dimensioni | Dimensions

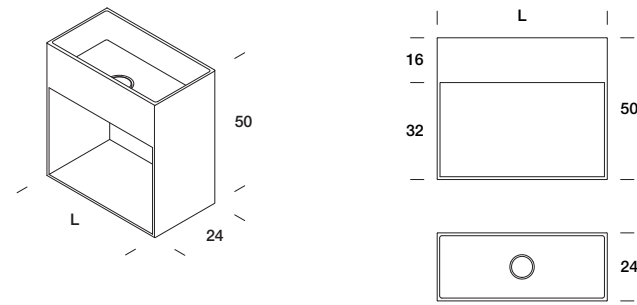

Fissaggi e piletta scarico libero a filo inclusa, sifone escluso | Fixings and free flow drain included; siphon excluded | Fixations et bonde à écoulement libre à fil inclus, siphon non compris | Befestigung und freier Ablauf inklusiv; Siphon ausgeschlossen | Accesorios y desagüe libre incluidos, sifón excluido

Foro rubinetto | Tap hole

COD	MISCELATORE REXA / REXA FAUCET	ALTRO MISCELATORE / OTHER FAUCET
91020101	0	109

Installazione | Installation



Rubinetteria | Faucet



Scarico | Drain

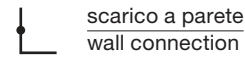

Pesi e volumi | Weight and volume

Kg	Kg	M³
16,5	21,5	0,14

Corian®

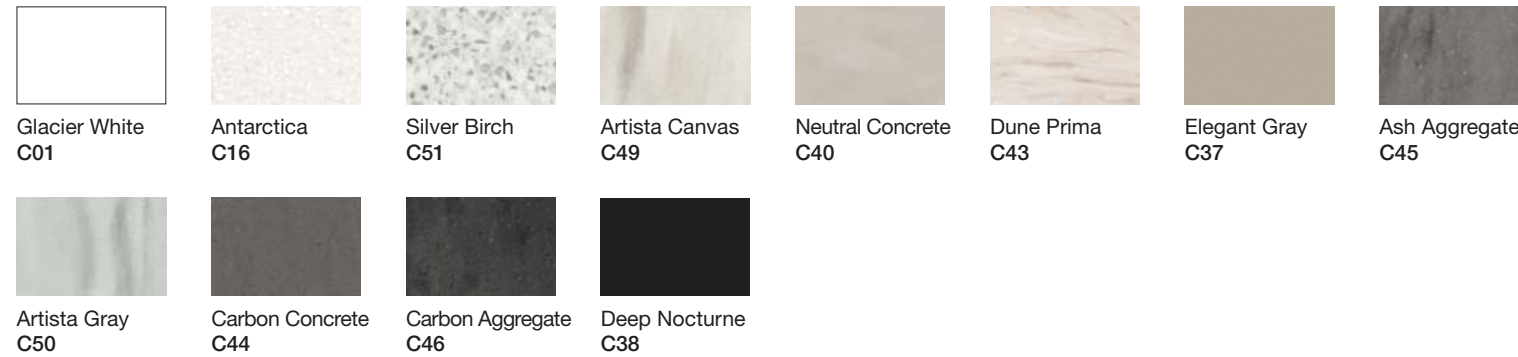

Unico con anta

Unico with door | Unico avec porte | Unico mit Tür | Unico con puerta

Dimensioni | Dimensions

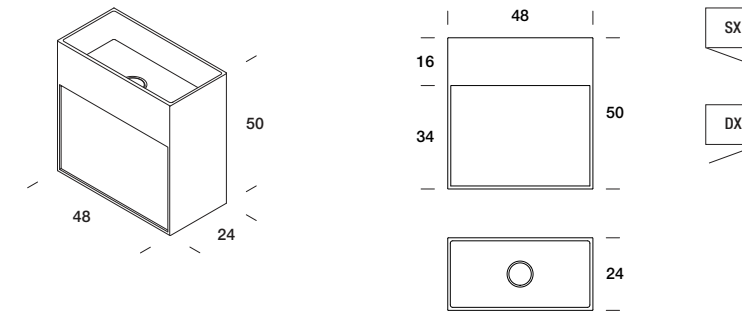

Fissaggi e piletta scarico libero a filo inclusa, sifone escluso | Fixings and free flow drain included; siphon excluded | Fixations et bonde à écoulement libre à fil inclus, siphon non compris | Befestigung und freier Ablauf inklusiv; Siphon ausgeschlossen | Accesorios y desagüe libre incluidos, sifón excluido

Foro rubinetto | Tap hole

COD	MISCELATORE REXA / REXA FAUCET	ALTRO MISCELATORE / OTHER FAUCET
91020101	0	109

Installazione | Installation



Rubinetteria | Faucet



Scarico | Drain

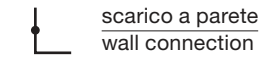

Pesi e volumi | Weight and volume

Kg	Kg	M³
17,5	22,5	0,12

Abbinabilità Rexa | Rexa combinations

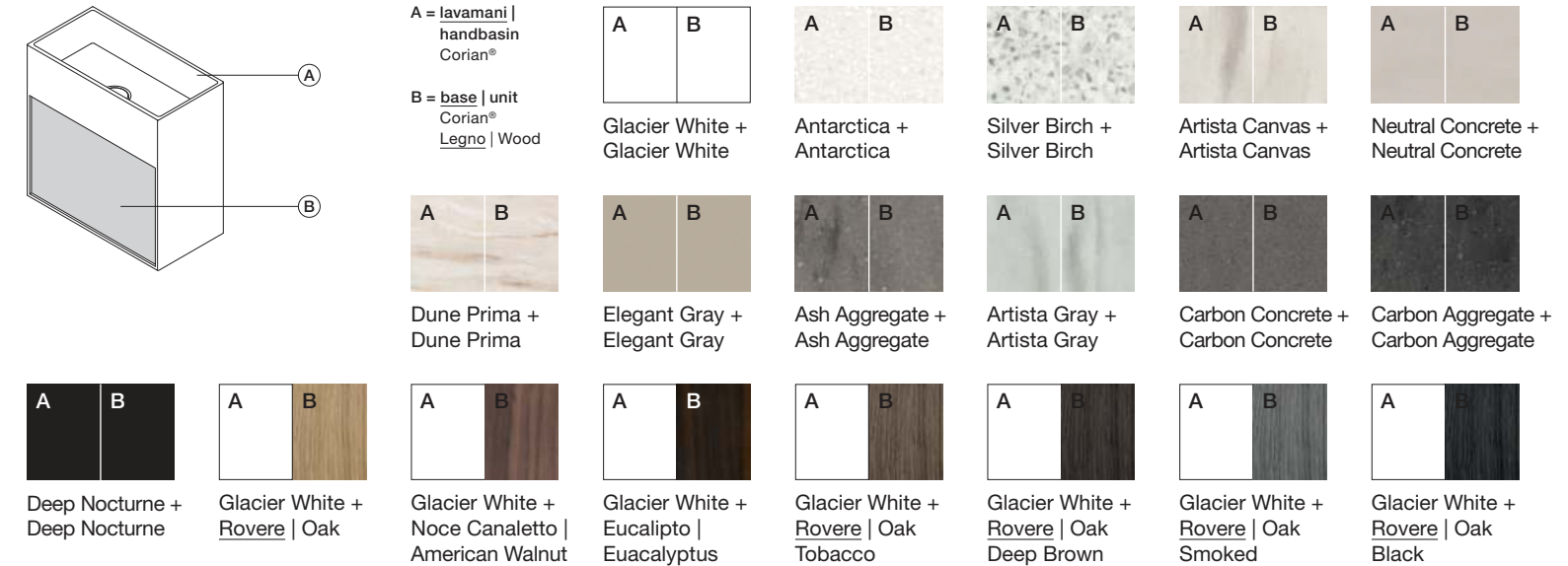

Unico con doppia anta

Unico with double door | Unico avec double porte | Unico mit Doppeltür | Unico con doble puerta

Dimensioni | Dimensions

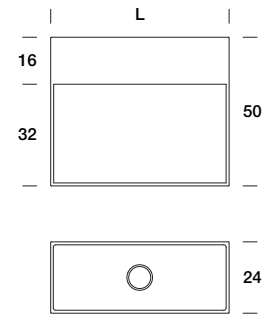
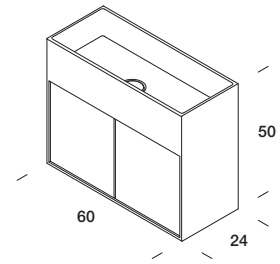

Fissaggi e piletta scarico libero a filo inclusa, sifone escluso | Fixings and free flow drain included; siphon excluded | Fixations et bonde à écoulement libre à fil inclus, siphon non compris | Befestigung und freier Ablauf inklusiv; Siphon ausgeschlossen | Accesorios y desagüe libre incluidos, sifón excluido

Foro rubinetto | Tap hole

COD	MISCELATORE REXA / REXA FAUCET	ALTRO MISCELATORE / OTHER FAUCET
91020101	0	109

Installazione | Installation



Rubineria | Faucet



Scarico | Drain

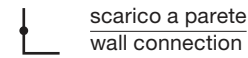

Pesi e volumi | Weight and volume

Kg	Kg	M³
20,5	25,5	0,14

Abbinabilità Rexa | Rexa combinations

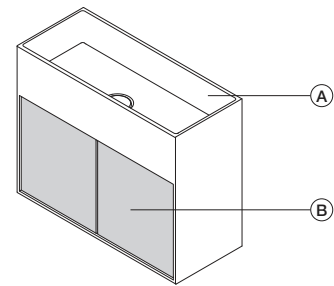

A = lavamani | handbasin
Corian®
B = base | unit
Corian®
Legno | Wood

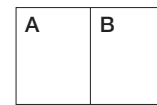

Glacier White + Glacier White

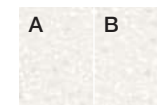

Antarctica + Antarctica

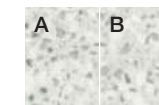

Silver Birch + Silver Birch

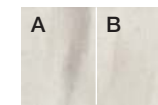

Artista Canvas + Artista Canvas

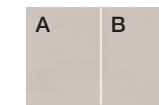

Neutral Concrete + Neutral Concrete



Dune Prima + Dune Prima



Elegant Gray + Elegant Gray

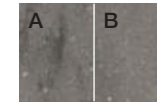

Ash Aggregate + Ash Aggregate

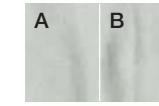

Artista Gray + Artista Gray

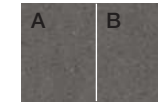

Carbon Concrete + Carbon Concrete

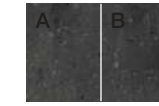

Carbon Aggregate + Carbon Aggregate



Deep Nocturne + Deep Nocturne

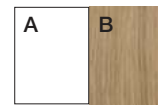

Glacier White + Rovere | Oak

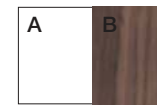

Glacier White + Noce Canaletto | American Walnut

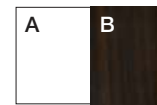

Glacier White + Eucalipto | Euacalyptus

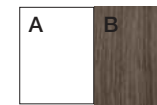

Glacier White + Rovere | Oak Tobacco

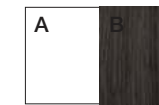

Glacier White + Rovere | Oak Deep Brown

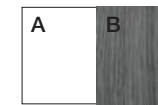

Glacier White + Rovere | Oak Smoked

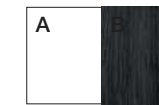

Glacier White + Rovere | Oak Black

Accessori Mignon, Box e Unico

Mignon, Box and Unico accessories | Mignon, Box et Unico accessoires | Mignon, Box und Unico Zubehören | Mignon, Box y Unico accesorios

Mensola contenitiva a parete in Corian® | Corian® wall holder shelf | Bac murale en Corian® | Wandregal aus Corian® | Estante a pared en Corian®

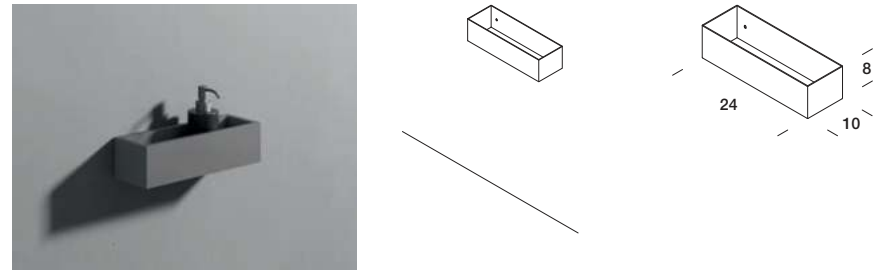

Portasalvietta per lavabo in Corian® | Corian® towel rail for basin | Porte-serviette en Corian® pour lavabo | Hantuchhalter aus Corian® für Waschbecken | Toallero en Corian® para lavabo

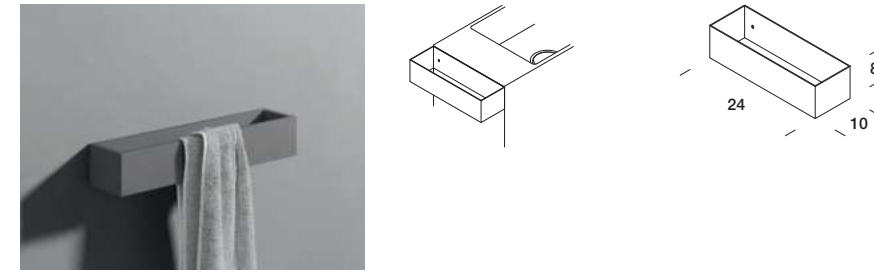

Mensola contenitiva per lavabo in Corian®

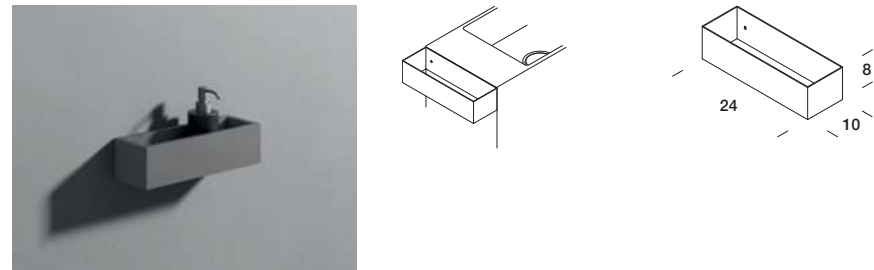

Corian®

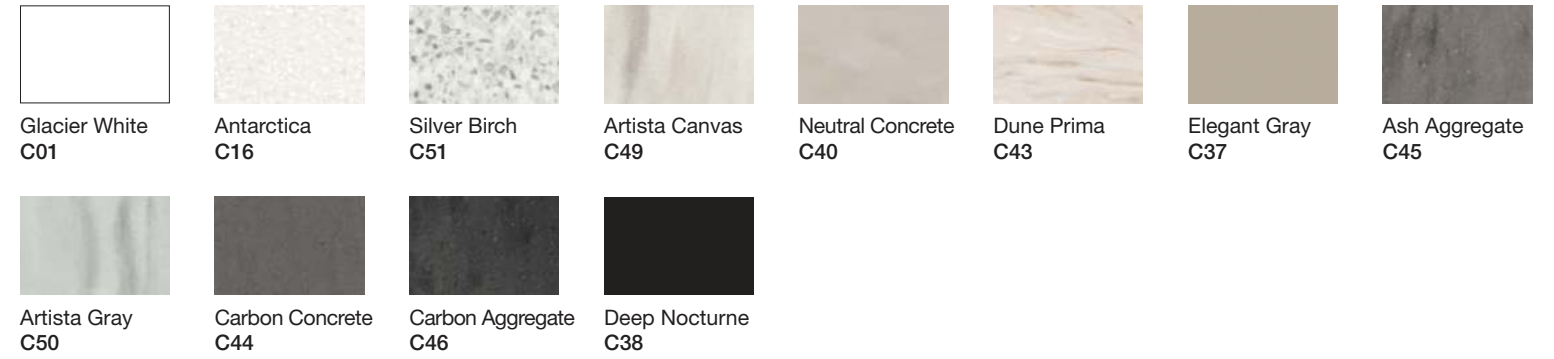

Portasalvietta a parete in Corian® | Wall mounted Corian® towel rail | Porte serviette mural en Corian® | Hantuchhalter aus Corian® an Wand | Toallero en Corian® a pared

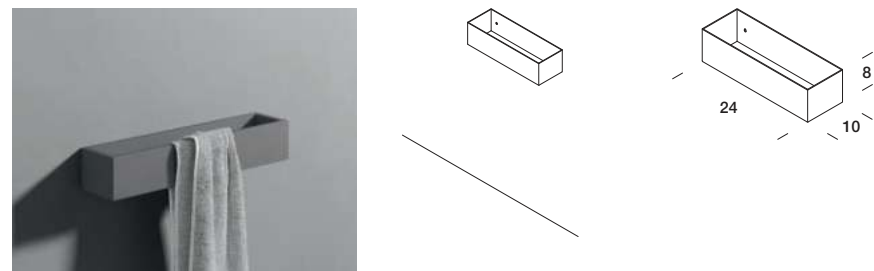

Accessori Mignon, Box e Unico

Mignon, Box and Unico accessories | Mignon, Box et Unico accessoires | Mignon, Box und Unico Zubehören | Mignon, Box y Unico accesorios

Mensola contenitiva a parete in Lamiera | Metal wall holder shelf | Étagère murale en métal | Metall Wandhalter Regal | Estante de pared metal

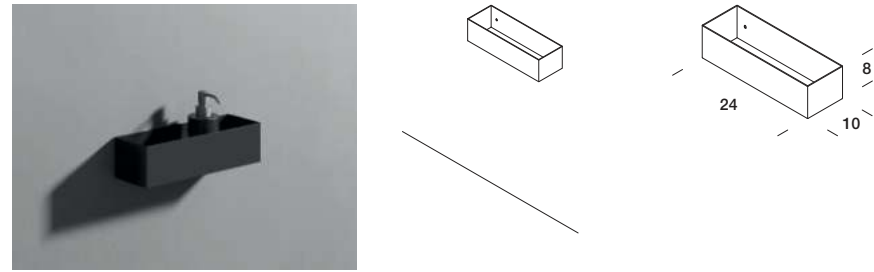



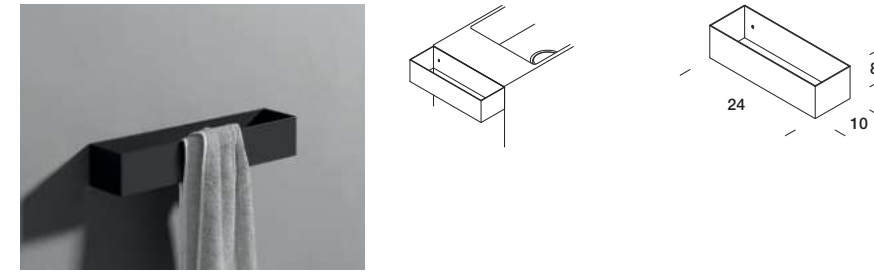



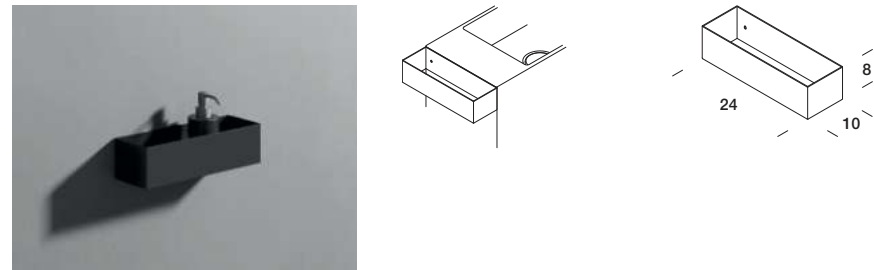









Portasalviette per lavabo in Lamiera | Metal towel rail for basin | Porte serviette en métal pour lavabo | Hantuchhalter aus Metall für Waschbecken | Toallero en metal para lavabo



Mensola contenitiva per lavabo in Lamiera



Lamiera verniciata opaca | Matt painted metal (base | unit)

								
Bianco LR1	Beige Fresco LR40	Beige LR42	Zenzero LR47	Grigio Luce LR39	Grafite LR32	Nero LR2		
								
Sabbia LR33	Fango Luce LR35	Fango LR31	Tortora LR04	Rosa Polvere LR48	Rosso Cupo LR37	Rosa Fumo LR36	Melanzana LR38	
								
Grigio Muschio LR45	Grigio Foresta LR49	Verde Pino LR46	Azzurro LR43	Blu Desaturo LR44				

Portasalviette a parete in Lamiera | Wall mounted metal towel rail | Porte-serviette mural en métal | Hantuchhalter aus Metall an Wand | Toallero en metal a pared

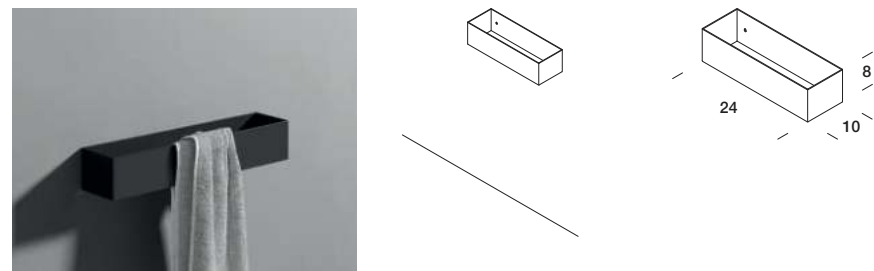

Miscelatori

Faucets | Mitigeurs | Armaturen | Monomandos

79 **Miscelatori | Faucets**

80 Mae Contract
Mae
Drop
Dot
Virgola

82 Pilette e sifoni | Drains and siphons

Miscelatori

Faucets | Mitigeurs | Armaturen | Monomandos

MAE CONTRACT — Miscelatore monocomando lavabo da piano

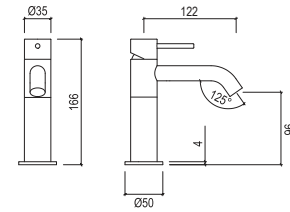

Single lever basin mixer | Mitigeur de lavabo pour plan | Einhebel-Waschtischmischer bodenstehend | Grifo monomando lavabo

MAE — Miscelatore monocomando lavabo da piano

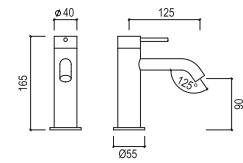

Single lever basin mixer | Mitigeur de lavabo pour plan | Einhebel-Waschtischmischer bodenstehend | Grifo monomando lavabo

MAE — Miscelatore lavabo incasso due fori canna corta

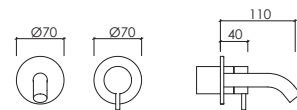
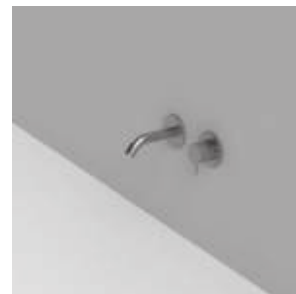

Two-hole built-in basin mixer short spout | Mitigeur de lavabo encastré, deux perçages, bec court | Zwei-Loch Wandwaschtischmischer, kurzer Auslauf | Mezclador para lavabo empotrado, dos agujeros, cãno corto

MAE — Miscelatore lavabo incasso piastra unica canna corta

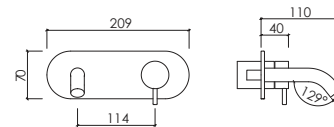
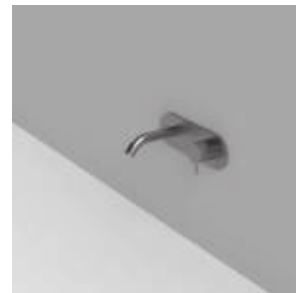

Built-in basin mixer with backplate and short spout | Mitigeur de lavabo encastré, avec plaque unique et bec court | Wandwaschtischmischer, mit Wandplatte kurzer Auslauf | Mezclador para lavabo empotrado, placa única y, cãno corto

DROP — Miscelatore monocomando lavabo da piano

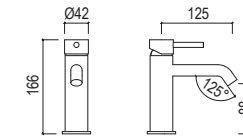

Single lever basin mixer | Mitigeur lavabo pour plan | Einhebel-Waschtischmischer auf Platte | Grifo monomando lavabo

DOT — Miscelatore monocomando lavabo

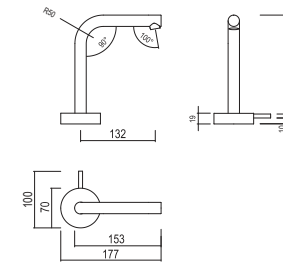

Single lever basin mixer | Mitigeur de lavabo à levier unique pour plan | Einhebel Waschtischmischer bodenstehend | Grifo monomando lavabo

VIRGOLA — Rubinetto lavabo monoacqua

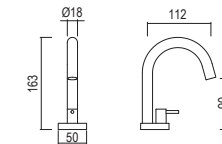

Cold water single lever basin mixer | Mitigeur de lavabo eau froide à levier unique pour plan | Einhebel-Waschtischmischer bodenstehend | Grifo monomando monoacqua lavabo

Pilette e sifoni

Drains and siphon | Bondes et siphons | Ablaufgarnitur und Siphon | Desagüe y sifon

Piletta scarico libero Universale da 1" 1/4



Universal free ow basin drain 1" 1/4 |
Bonde universelle à écoulement libre 1" 1/4 |
Ablaufgarnitur universal "freilauf" von 1" 1/4 |
Válvula de lavabo Desagüe libre universal 1" 1/4

Sifone

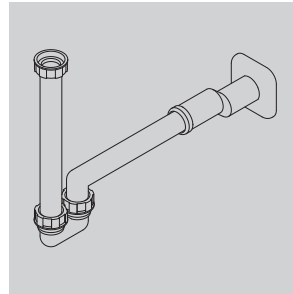

Siphon | Siphons | Siphons | Sifones

Specchiere

Mirrors | Miroirs | Spiegel | Espejos

83 **Specchiere | Mirrors**

84 Filolucido

85 Rettangolo
Fonte
Filolucido rotonda | Round Filolucido

86 Hammam
Hole
Pois

Specchiere

Mirrors | Miroirs | Spiegel | Espejos

Filolucido orizzontale | Horizontal Filolucido | Filolucido horizontal | Horizontaler Filolucido | Horizontal Filolucido

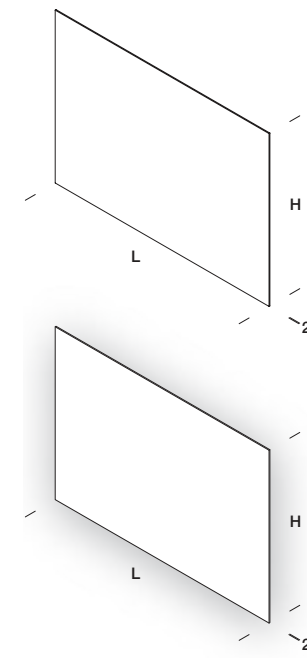

Temperatura | Temperature
4000 K

Filolucido verticale | Vertical Filolucido | Filolucido vertical | Vertikaler Filolucido | Vertical Filolucido

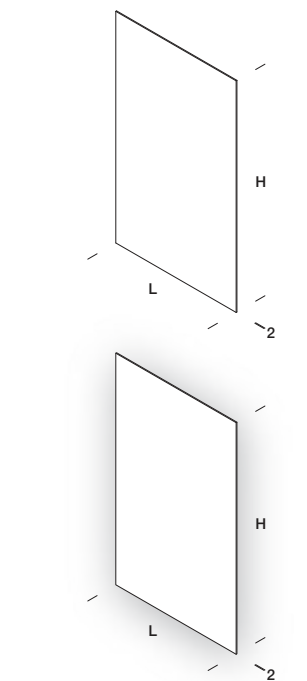

Temperatura | Temperature
4000 K

Rettangolo orizzontale | Horizontal Rettangolo | Rettangolo orizzontale | Horizontaler Rettangolo | Rettangolo horizontales

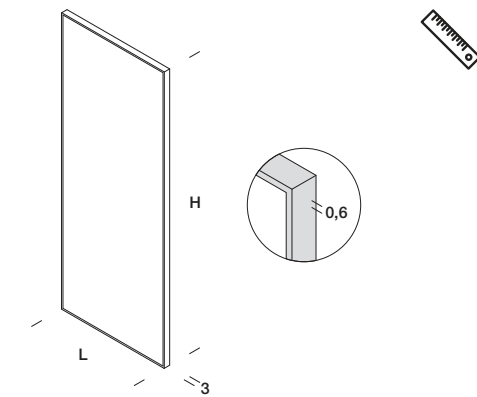

Fonte

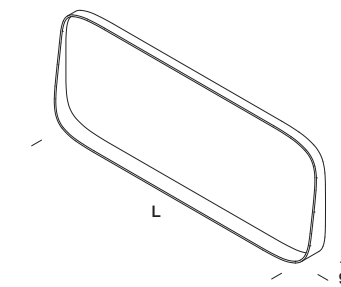

Filolucido rotonda | Round Filolucido | Filolucido rond | Runder Filolucido | Filolucido redondo

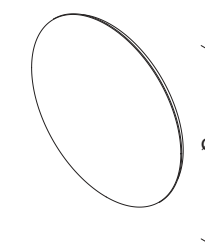

Temperatura | Temperature
3000 K

Specchiere

Mirrors | Miroirs | Spiegel | Espejos

Hamman

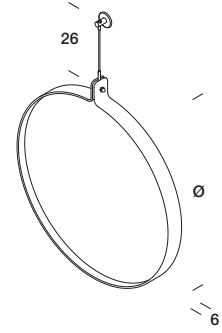

Pois orizzontale dx o sx con cornice in lamiera | Pois horizontal right or left mirror with metal shelf | Miroir horizontal Pois D. ou G. avec étagère en métal | Horizontaler Spiegel Pois Li. oder Re. mit Rahmen aus Metall | Espejo horizontal Pois D. o I. con estante en metal

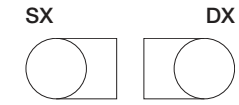
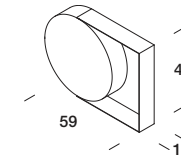

Halo

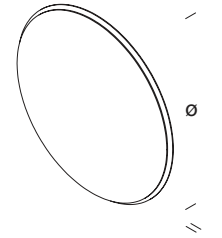

Temperatura | Temperature
4000 K

Pois verticale con cornice in Corian® | Pois vertical mirror with Corian® shelf | Miroir vertical Pois avec étagère en Corian® | Senkrecht Spiegel Pois mit Rahmen aus Corian® | Espejo vertical Pois con estante en Corian®

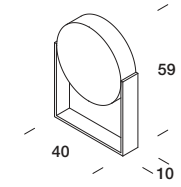

Pois orizzontale dx o sx con cornice in Corian® | Pois horizontal right or left mirror with Corian® shelf | Miroir horizontal Pois D. ou G. avec étagère en Corian® | Horizontaler Spiegel Pois Li. oder Re. mit Rahmen aus Corian® | Espejo horizontal Pois D. o I. con estante en Corian®

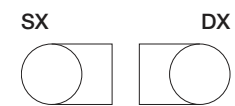
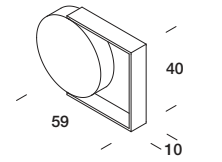

Pois verticale con cornice in lamiera | Pois vertical mirror with metal shelf | Miroir vertical Pois avec étagère en métal | Senkrecht Spiegel Pois mit Rahmen aus Metall | Espejo vertical Pois con estante en metal

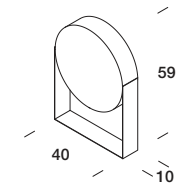

Specchiere

Mirrors | Miroirs | Spiegel | Espejos

Pois orizzontale dx o sx con cornice in Corian® | Pois horizontal right or left mirror with Corian® shelf | Miroir horizontal Pois D. ou G. avec étagère en Corian® | Horizontaler Spiegel Pois Li. oder Re. mit Rahmen aus Corian® | Espejo horizontal Pois D. o I. con estante en Corian®

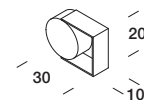

Specchio ingranditore | Cosmetic mirror |
Miroir grossissant | Vergrößerungsspiegel |
Espejo de aumento

Pois orizzontale dx o sx con cornice in lamiera | Pois horizontal mirror with metal shelf | Miroir horizontal Pois D. ou G. avec étagère en métal | Horizontaler Spiegel Pois Li. oder Re. mit Rahmen aus Metall | Espejo horizontal Pois D. o I. con estante en metal

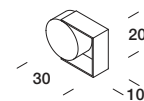

Specchio ingranditore | Cosmetic mirror |
Miroir grossissant | Vergrößerungsspiegel |
Espejo de aumento

Materiali

Materials

Korakril™ Blend



Impiegato per la realizzazione di lavamani |
For handbasins manufacturing | Utilisé pour la
réalisation de lave-mains | Für die Herstellung
von Handwaschbecken | Utilizado para la
fabricación de lavamanos

Parte della famiglia dei Solid Surface, Korakril™ Blend è un materiale realizzato dalla combinazione tra minerali naturali e resine di altissima qualità. Korakril™ Blend nasce sottoforma di resina liquida che viene iniettata in stampi per creare il prodotto finale. Grazie a questi processi di lavorazione, Korakril™ Blend risulta un materiale compatto e omogeneo sull'intera superficie che, non presentando nessuna porosità, lo rende igienico, ignifugo e antibatterico.

As a solid surface, Korakril™ Blend is a material made from the combination of natural minerals and very high quality resins. Korakril™ Blend is basically in the form of liquid resin which is injected into molds to create the final product. Thanks to these manufacturing processes, Korakril™ Blend is a compact and homogeneous material on the entire surface which, without presenting any porosity, makes it hygienic, flame retardant and antibacterial.

Faisant partie de la famille Solid Surface, le Korakril™ Blend est un matériau fabriqué à partir de la combinaison de minéraux naturels et de résines de très haute qualité. Korakril™ Blend est né sous forme de résine liquide qui est injectée dans des moules pour créer le produit final. Grâce à ces procédés de fabrication, Korakril™ Blend est un matériau compact et homogène sur toute la surface qui, sans présenter de la porosité, le rend hygiénique, ignifuge et antibactérien.

Verbundwerkstoff mit 2/3 Aluminiumhydrate, gemischt mit Polyesterharzen, modifiziert mit Acrylmonomeren mit hohen chemischen und mechanischen Leistungen gemacht, um die Homogenität und die Gleichförmigkeit durch die Dicke

zu gewährleisten. Kompakte Bauweise, Beständigkeit gegenüber Chemikalien und / oder Lösungsmittel und Kratzfestigkeit sind die Hauptmerkmale von Korakril™ Mischung.

Parte de la familia de Solid Surface, Korakril™ Blend es un material hecho de la combinación de minerales naturales y resinas de muy alta calidad. Korakril™ Blend nació en forma de resina líquida que se inyecta en moldes para crear el producto final. Gracias a estos procesos de fabricación, Korakril™ Blend es un material compacto y homogéneo en toda la superficie que, sin presentar porosidad, lo hace higiénico, ignífugo y antibacteriano.

 non poroso
non porous

 igienico
hygienic

 Materiale a iniezione
Injection material

 facilmente ripristinabile
easy restorable



Impiegato per la realizzazione di lavamani |
For handbasins manufacturing | Utilisé pour la
réalisation de lave-mains | Für die Herstellung
von Handwaschbecken | Utilizado para la
fabricación de lavamanos

Corian® è un materiale non poroso, omogeneo e inalterabile alla luce, composto da $\pm 1/3$ di resina acrilica (polimetil-metacrilato o PMMA) e da $\pm 2/3$ di sostanze minerali. Il componente principale è il tri-idrato di alluminio (ATH), minerale derivato dalla bauxite, da cui si ricava l'alluminio. Dal 1967, anno della sua produzione, a oggi il Corian® ha dimostrato di essere un materiale resistente, versatile e igienico. Non essendo poroso, muffe e batteri non trovano appigli e non possono diffondersi nelle giunture o sotto la superficie. Inerte e non tossico, in condizioni normali di temperatura non emette gas. Quando viene bruciato rilascia ossidi di carbonio, il fumo è leggero e non contiene gas alogeni tossici. Per ulteriori informazioni consultare il sito internet: www.dupont.it

Corian® is a solid, non-porous, homogeneous surfacing material, composed of $\pm 1/3$ acrylic resin (also known as Polymethyl Methacrylate or PMMA), and $\pm 2/3$ of natural minerals. These minerals are composed of Aluminium Trihydrate (ATH) derived from bauxite, an ore from which aluminium is extracted. Since its birth in 1967 Corian® has proved to be really resistant, versatile and hygienic. Being a non-porous material, mold and bacteria cannot root nor spread themselves in the joints or under the surface. Corian® is non-toxic and inert. In normal temperature conditions is not emitting gas. If burnt releases mostly carbon monoxide and the light smoke does not have any halogen toxic gas. For further information on its composition, consult the website: www.corian.uk

Corian® est un matériel de revêtement homogène massif et non poreux, composé de $\pm 1/3$ de résine acrylique (également connue sous le nom de Polyméthyle

Méthacrylate ou PMMA), et de $\pm 2/3$ de minéraux naturels. Son composant principal est le Trihydrate de la bauxite (ATH), un minéral dérivé de la bauxite, le minéral dont on extrait l'aluminium. Depuis sa naissance en 1967, Corian® a démontré d'être vraiment résistant, versatile et hygiénique. Etant aussi un matériel homogène et non-poreux, moisissures et bactéries ne se déposent pas ni dans les joint et ni en dessous de la surface. Corian® est inerte et nontoxique. En condition de température normale, il génère aucune émission de gaz. En cas de combustion, il émet surtout des oxydes de carbone et le fumée est légère et contient pas des gaz halogènes toxiques. Pour plus d'information, consultez le site: www.dupontdenemours.fr

Corian® ist ein massives, nicht poröses und homogenes Oberflächenmaterial aus $\pm 1/3$ Acrylharz (auch als Polymethylmetacrylat oder PMMA bekannt) und $\pm 2/3$ natürlichen Mineralien. Der Hauptbestandteil ist das Mineral Aluminiumhydroxid (ATH), das aus Bauxit (Aluminiumerz) gewonnen wird. Seit der Markteinführung im Jahr 1967 hat sich Corian® als langlebiges und nutzerfreundliches Material bewährt. Das porenlose, massive Corian® kann optisch fugenlos verarbeitet werden und verfügt deshalb über eine besonderes hygienische Oberfläche. Diese verhindert das Wachstum von Bakterien oder Schimmelpilzen. Corian® ist ein inaktives, nicht toxisches Material. Bei Normaltemperatur kommt es zu keiner Gasentwicklung. Wird es verbrannt, setzt der Werkstoff hauptsächlich Kohlendioxid frei. Der Rauch ist optisch hell und enthält keine toxischen halogenierten Gase. Informationen zur Materialzusammensetzung entnehmen Sie bitte dem Corian® auf: www.dupont.de

Corian® es un material no poroso, homogéneo e inalterable a la luz, compuesto de $\pm 1/3$ de resina acrílica (también conocida como Polimetil-Metacrilato o PMMA) y $\pm 2/3$ de minerales naturales. Su principal ingrediente es el mineral trihidrato de aluminio (ATH), un derivado de la bauxita que sirve de base para la producción de aluminio. Desde su introducción en 1967, Corian® ha demostrado ser un material resistente, versátil e higiénico. Como no es poroso, el moho y las bacterias no encuentran bodegas y no pueden propagarse en las articulaciones o debajo de la superficie. Corian® es un material inerte y no tóxico. Bajo condiciones normales de temperatura, no emite gases. Cuando se quema, principalmente desprende gas carbónico, el humo que genera es liviano y no contiene gases halogenados tóxicos. Para tener más información sobre la composición del material, consulte Corian® la página: www.dupont.es



non poroso
non porous



igienico
hygienic



termoformabile
thermo-formable



facilmente ripristinabile
easy restorable



assenza di giunzioni
absence of joints



inalterabile alla luce
lightfast



Impiegato per la realizzazione di lavamani |
For handbasins manufacturing | Utilisé pour la
réalisation de lave-mains | Für die Herstellung
von Handwaschbecken | Utilizado para la
fabricación de lavamanos

Materiale realizzato con una miscela di resine acriliche e minerali naturali, il Korakril™ è resistente, igienico, antistatico, inalterabile alla luce, resistente alle macchie e termoformabile: le lastre scaldate possono essere modellate con stampi di legno o metallo, creando forme bi e tridimensionali. La sua particolare composizione permette di realizzare top in totale assenza di giunzioni percettibili con il vantaggio di una continuità estetica all'interno delle composizioni. L'uniformità del materiale impedisce che si possano verificare punti critici per lo sporco o il deposito di batteri e muffe. Questo materiale viene realizzato sia in versione bianca opaca sia in quella colorata disponibile in cinque differenti tonalità. La presenza discreta di granuli visibili dei vari minerali di diverse dimensioni e cromie, conferisce un aspetto materico alla superficie mantenendo la sua omogeneità nell'intera superficie.

Material realised with a mixture of acrylic resins and natural minerals. Korakril™ is resistant, hygienic, anti-static, inalterable to light, stain resistant and can be thermoformed: the heated slabs can be moulded with wooden or metal moulds, creating two and three-dimensional shapes. The particular composition of Korakril enables the manufacture of tops without visible joints that make the composition continuative. With its uniformity, you will not find critical point for the deposit of dust and neither for bacteria. This material is made both in a matt white version and in a colored one available in five different shades. The discreet presence of different sizes and colours of various minerals visible grains, gives the surface a texture effect while maintaining its homogeneity throughout the entire surface.

C'est un matériel réalisé avec un mélange des résines acryliques. Korakril est résistant, hygiénique,

antistatique, inaltérable à la lumière, résistant aux taches et thermoformable: les dalles chauffées peuvent être modélisées avec des moules en bois ou en métal, en créant des formes bidimensionnelles et tridimensionnelles. Sa particulière composition permet de réaliser des plans tops sans joints visibles avec l'avantage d'avoir une continuité esthétique à l'intérieur des compositions. L'uniformité de ce matériel empêche la formation des points critiques pour la poussière ou l'accumulation des bactéries. Ce matériau est fabriqué soit en version blanc mat soit en couleur disponible en cinq teintes différentes. La présence discrète de grains visibles de divers minéraux de différentes tailles et couleurs donne à la surface un aspect matériel tout en conservant son homogénéité sur toute la surface.

Ist eine Mischung von Acrylherzen und natürlichen Mineralen. Korakril ist fest, hygienisch, antistatisch, lichtecht, fleckbeständig und man kann es Thermoformen: die beheizten Platten können mit Holzoder Metallformen modelliert werden, um bi oder dreidimensionale Formen zu schaffen. Mit dieser speziellen Zusammensetzung, kann man mit Korakril Platten ohne Verbindungen realisieren, die den Kompositionen eine schöne ästhetische Kontinuität bieten. Die Gleichmäßigkeit des Material gibt die Möglichkeit eine andauernde saubere Oberfläche ohne kritische Punkte für Schmutz zu haben. Inert und ungiftig, es kann an öffentlichen Plätzen verwendet werden, da es keinerlei Gas ausströmt. Die Herstellung von Korakril entsteht mit Systemen, die den Abfall minimieren, der jedoch auch in den Produktionsprozess zurückgeführt wird, ein optimiertes Verfahren, das auf die maximale Energieeinsparung führt.

Es un material realizado por una mezcla de resinas acrílicas y minerales naturales. Korakril es resistente, higiénico, antiestático, inalterable a la luz, resistentes a las manchas y puede ser termoformado: las losas calentadas pueden ser modeladas con moldes de madera o de metal, creando formas bidimensionales y tridimensionales. La composición particular de Korakril permite realizar encimeras en total ausencia de uniones perceptibles donando continuidad estética a las composiciones. La uniformidad del material no permite el deposito de mugre y bacterias. Este material está hecho tanto en una versión blanca mate como en una de color disponible en cinco tonos diferentes. La presencia discreta de granos visibles de varios minerales de diferentes tamaños y colores le da a la superficie una apariencia matérica mientras mantiene su homogeneidad en toda la superficie



non poroso
non porous



igienico
hygienic



materiale a iniezione
Injection material



facilmente ripristinabile
easy restorable



assenza di giunzioni
absence of joints



inalterabile alla luce
lightfast

Pulizia Corian® e Korakril™ (Blend e colorato)

Uso e manutenzione Corian® e Korakril™ (Blend e colorato)

Manutenzione giornaliera A – B – C

Acqua ricca di calcare, sapone, minerali A – B – F – H

Graffio significativo, bruciatura di sigaretta, inchiostro, segni di penna A – B – C – E – H

Mercurocromo, sangue, profumo A – B – C – D – E – H

Smalto per unghie A – B – C – G – H

Ferro o ruggine A – B – C – G – H

Iodio A – B – C – E – H

Corian® colorato A – B – G

Agire sempre con movimenti circolari. Se non viene rimossa completamente risciacquando con acqua, la candeggina può scolorire il Corian®.

E. Usare una spugna, strofinare sulla macchia con candeggina diluita con acqua, sciacquare più volte con acqua calda e asciugare con un panno morbido.

F. Usare una spugna e strofinare sulla macchia con un prodotto di pulizia anticalcare (tipo Viakal®) o aceto. Sciacquare più volte con acqua calda ed asciugare con un panno morbido.

G. Usare una spugna e strofinare sulla macchia con un prodotto privo di acetone. Sciacquare più volte con acqua calda ed asciugare con un panno morbido.

H. Se le macchie persistono, contattare Rexa Design (tel: 0434 593182).

Molti danni dovuti a urti, calore o prodotti chimici possono essere riparati solitamente sul luogo ridando integralmente alla superficie il suo aspetto originale, regolare, igienico.

Metodi di pulizia

A. Rimuovere il residuo con un panno.

B. Sciacquare la superficie con acqua calda e asciugare con un panno morbido.

C. Usare un panno umido e una crema abrasiva leggera (es. Cif).

D. Usare una spugna, strofinare sulla macchia con un prodotto detergente a base di ammoniaca.

Cleaning methods for Corian®, Korakril™ (Blend and colored)

Corian® and Korakril™ (Blend and colored) use and maintainance

For everyday cleaning A – B – C

Water rich of limestone, soaps, minerals A – B – F – H

Light scratch, cigarette burns, ink, marker pen A – B – C – E – H

Mercurochrome, blood, perfume A – B – C – D – E – H

Nail varnish spills A – B – C – G – H

Iron or rust A – B – C – G – H

Iodine A – B – C – E – H

Colored Corian® A – B – G

Always clean using circular motion. Bleach can discolour Corian® if not removed completely by rinsing with water afterwards.

F. Use a microfiber cloth and rub over the stain with a standard household lime-scale remover (Viakal®, Lime-lite) or vinegar . Rinse several times with warm water and dry with a soft cloth.

G. Use a microfiber cloth and rub over the stain with a non-acetone based Nail varnish remover. Rinse several times with warm water and dry with a soft cloth.

H. If the stains persist, contact Rexa Design (tel: +39 0434 593182).

Most damages, including sever impact, heat or chemical damage, can usually be repaired on site to restore the original, smooth, hygienic solid surface integrity.

Cleaning methods

A. Remove excess with a soft cloth.

B. Rinse surface with warm water and dry with a soft cloth.

C. Use a damp microfiber cloth and a light abrasive cream.

D. Use a microfiber cloth and wipe the stain with an ammonia detergent

E. Use a microfiber cloth and rub over the stain with some diluted bleach. Rinse several times with warm water and dry with a soft cloth.



Corian®, Korakril™ (Blend et coloré) Methodes de nettoyage

Corian® et Korakril™ (Blend et coloré) utilisation et maintenance

Nettoyage quotidien A – B – C

Dépôt calcaire, savons, minéraux A – B – F – H

Égratignure importante, brûlure de cigarette, encre, marques de stylo A – B – C – E – H

Mercurochrome, sang, parfum A – B – C – D – E – H

Vernis à angle A – B – C – G – H

Fer ou rouille A – B – C – G – H

Iode A – B – C – E – H

Corian® coloré A – B – G

Nettoyez toujours en effectuant un mouvement circulaire. L'eau de javel risque de décolorer le Corian® si elle n'est pas ensuite rincée complètement à l'eau.

Methodes de nettoyage

A. Épongez avec un chiffon doux.

B. Rincez à l'eau chaude et séchez avec un chiffon doux.

C. Utilisez un chiffon humide et un détergent doux en crème (type Cif).

D. Utilisez une éponge et frottez la tâche avec un détergent ou un nettoyeur pour surface dure à l'ammoniaque dilué (type Ajax ou Monsieur Propre).

E. Utilisez une éponge à récurer et frottez la tâche avec un peu d'eau de javel dilué. Rincez plusieurs fois à l'eau chaude, puis séchez avec un chiffon doux.

F. Utilisez une éponge à récurer et frotter la tâche avec un produit anti-calcaire (type Viakal®) ou de vinaigre. Rincez plusieurs fois à l'eau chaude, puis séchez avec un chiffon doux.

G. Utilisez une éponge à récurer et frottez la tâche avec un dissolvant à ongles sans acétone. Rincez plusieurs fois à l'eau chaude, puis séchez avec un chiffon doux.

H. Si la tache persiste, contactez Rexa Design (tel: +39 0434 593182).

La plupart des dégâts, y compris les dommages importants dus à un choc, à la chaleur ou à des produits chimiques, sont habituellement réparables sur place pour redonner aux

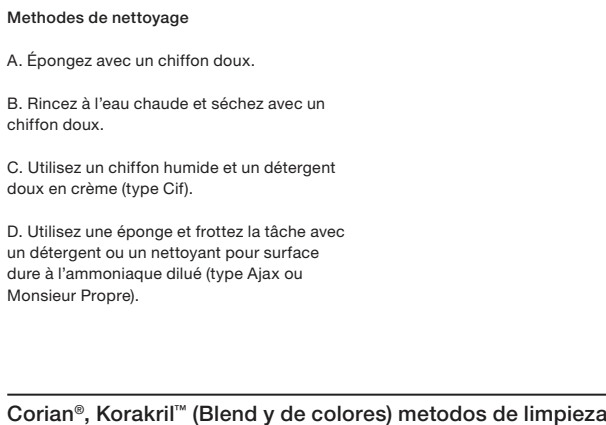

Corian®, Korakril™ (Blend y de colores) metodos de limpieza

Corian® y Korakril™ (Blend y de colores) uso y mantenimiento

Para la limpieza cotidiana A – B – C

Cal de agua dura, jabon, minerales A – B – F – H

Rasguños significativos, quemaduras de cigarrillos, tinta, marcas de lápiz A – B – C – E – H

Sangre, vino, perfume A – B – C – D – E – H

Manchas de esmalte de uñas A – B – C – G – H

Hierro u oxidacion A – B – C – G – H

Yodo A – B – C – E – H

Corian® de colores A – B – G

Siempre limpie con movimientos circulares. La Lejia puede dejar manchas blancas en la superficie de Corian® si no se aclare con agua abundante.

E. Con un estropajo que esté gastado frote la mancha con un poco de lejia diluida. Aclare varias veces con agua caliente y seque con un trapo suave.

F. Con un estropajo que esté gastado frote la mancha con un producto doméstico para eliminar los residuos de cal (Viakal®) o vinagre. Aclare varias veces con agua caliente y seque con un trapo suave.

G. Con un estropajo que esté gastado frote la mancha con un detergente sin acetona. Aclare varias veces con agua caliente y seque con un trapo suave.

H. Si la mancha persiste, contacte Rexa Design (tel: +39 0434 593182).

La mayoría de los daños, incluso los causados por un golpe, el calor y productos quimicos, se pueden reparar en el sitio de instalación.

Metodos de limpieza

A. Elimine manchas con un trapo suave.

B. Aclare la superficie con agua caliente y segue con un trapo suave.

C. aplique una crema ligeramente abrasiva (como Cif) con un paño mojado.

D. Con un estropajo que esté gastado frote la mancha con un producto para limpiar superficies sólidas a base de amoniaco.

Corian®, Korakril™ (Blend und farbig) Reinigungsmethode

Corian® et Korakril™ (Blend und farbig) gebrauch und wartung

Tägliche Reinigung A – B – C

Kalk-, Seifen- Mineralablagerungen A – B – F – I

Lilienpollen, Safran, leichte Kratzer, Zigarettenbrandflecke Tinte, Filzstift A – B – C – E – I

Mercurochrom, Blut, Rotwein, Parfum A – B – C – D – E – I

Nagellack A – B – C – G – I

Eisen oder Rost A – B – C – H – I

Jod A – B – C – E – I

*Reinigen Sie die Oberfläche immer mit kreisenden Bewegungen
**Bleiche sofort mit Waser vollständig abspülen, andernfalls kann sich die Corian® Oberfläche verfärben.

Reinigungsmethode

A. Rückstände mit einem weichen Tuch entfernen.

B. Oberfläche mit warmen Wasser abspülen und mit einem weichen Tuch trockenwischen.

C. Ein feuchtes Tuch und eine milde Scheuermilch verwenden (z.B. Viss, Frosch Scheuermilch).

D. Mit einem abrasiven Scheuerschwamm (z.B. Scotch Brite®) und einem Reinigungs-mittel oder Reiniger für Massivoberflächen auf

Ammoniakbasis (z.B. Ajax, Meister Proper, General) über den Fleck reiben.

E. Mit einem abrasiver Scheuerschwamm (z.B. Scotch Brite®) und Haushaltsbleiche. Oberfläche mehrmals mit warmem Wasser abspülen und mit einem weichen Tuch trockenwischen.

F. Mit einem abrasiver Scheuerschwamm (z.B. Scotch Brite®) und einem standard-mäßigen Haushaltsmittel zur Entfernung von Kalkablagerungen (Sido) oder Essig über den Fleck reiben. Oberfläche mehrmals mit warmem Wasser abspülen und mit einem weichen Tuch trockenwischen.

G. Mit einem abrasiver Scheuerschwamm (z.B. Scotch Brite®) und einem acetonfreien Nagellackentferner über den Fleck reiben. Oberfläche mehrmals mit warmem Wasser abspülen und mit einem weichen Tuch trockenwischen.

H. Mit einem abrasiver Scheuerschwamm (z.B. Scotch Brite®) und einem Metallreiniger oder Rostentferner über den Fleck reiben. Oberfläche mehrmals mit warmem Wasser abspülen und mit einem weichen Tuch trockenwischen.

I. Wenn Flecken nicht entfernt werden können, setzen Sie sich mit Rexa Design (tel: +39 0434 593182) in Verbindung.

Die meisten Schäden, ei nschließlich Schäden, die durch starke Schläge, Hitze oder Chemikalien verursacht wurden, können in der Regel vor Ort beseitigt werden. Die Oberfläche erhält dadurch ihre ursprüngliche, glatte, hygienische und massive Oberflächenbeschaffenheit zurück.

Lamiera verniciata opaca | Matt painted metal



Impiegato per la realizzazione lavamani e accessori | For handbasins and accessories manufacturing | Utilisé pour la réalisation de lave-mains et accessoires | Für die Herstellung von Handwaschbecken und Zubehör | Utilizado para la realización de lavamanos y accesorios

Lamiera laccata con vernici poliuretaniche, antingiallenti con effetto testurizzato opaco a grana fine. La verniciatura avviene tramite resine poliesteri, 120 gr/m² di colore.



resistente
resistant

Metal sheet are lacquered with polyurethane paints, anti-yellowing with textured matte grain effect. The painting takes place through polyester resins, 120 gr/m² of colour.

Métal laqué avec vernis polyuréthane, anti-jaunâtre avec effet texturé mat à grain fin. La peinture a lieu au moyen de résines polyester, 120 gr/m² de couleur.

Blech mit Polyurethan Lack, vergilbungsfrei mit feinkörnigem Mattstruktureffekt. Malerei erfolgt durch Polyesterharze, 120 gr/m² von Farbe.

Chapa lacada con barnices poliuretánicos, antinamarillos con efecto texturizado opaco de grano fino. La pintura se realiza a través de resinas de poliéster, 120 gr/m² de color.

Pulizia
Per la pulizia della lamiera verniciata opaca utilizzare un panno asciutto con normali detergenti neutri.

Cleaning
To clean matt painted sheet metal use a dry cloth with normal neutral detergents.

Popreté
Pour le nettoyage du métal peint mat, utilisez une lingée sèche avec des détergents neutres.

Reinigung
Zur Reinigung von Matt lackierten Blechen, verwenden Sie ein trockenes Tuch mit normalen neutralen Reinigungsmitteln.

Limpiadura
Para la limpieza de la chapa laqueada mate, utilice un paño seco con detergentes neutros normales.

Legno | Wood



Impiegato per la realizzazione ante | For doors manufacturing | Utilisé pour la réalisation des portes | Für die Herstellung von Türen | Utilizado para la realización de puertas

Pannello di fibra di legno a media densità impiallacciato e finito con vernice trasparente opaca.



resistente
resistant

Medium density fiber board veneered and finished with matte varnish.



idrorepellente
waterproof

Panneau en MDF plaqué et fini avec un vernis mat.



durevole
durable

Mitteldichte Holzfaserplatte MDF mit transparenter Mattlackierung gefertigt.



eco-compatibile
eco-friendly

Panel de MDF chapado con madera y acabado con barniz mate.

Pulizia
Per la pulizia dei legni utilizzare un panno asciutto con normali detergenti neutri.

Cleaning
To clean the wood nish, use a dry cloth with neutral detergent.

Nettoyage
Nettoyer le bois à l'aide d'un chiffon sec et d'un détergent neutre.

Reinigung
Zur Reinigung der Hölzer, ein trockenes Tuch mit einem neutralen Reinigungsmittel verwenden.

Limpeza
Limpiar la madera con un paño seco y un detergente neutro.