



Lavabi Washbasins

A terra e sospesi, Freestanding and wall hung

Indice

Summary

04	Overview
06	Smoking
16	O_O
28	Discovolante
40	Fonte totem
44	Fonte
50	Hole
54	Unico rotondo
58	Argo
62	Unico
70	Roll
76	Funnel
80	Informazioni tecniche Technical informations

Rexa Design dà vita ad uno spazio bagno concepito non soltanto per trasmettere serenità e benessere, ma anche per ispirare chi lo vive. Tutto ciò si realizza grazie alla presenza di oggetti che caratterizzano l'ambiente, infondendogli personalità.

Rexa Design presenta il suo programma completo di lavabi freestanding, che combinano sensorialità e funzionalità, imponendosi come protagonisti della stanza da bagno, senza mai smettere di dialogare con gli elementi circostanti.

Rexa Design gives life to a space bathroom designed not only for transmit peacefulness and well-being, but also to inspire those who live it. All this is achieved through the presence of objects that characterize the environment, by giving it personality. Rexa Design presents its complete range of freestanding washbasins, which combine a sensory experience with the functionality, imposing itself as protagonists of the bathroom, but always connected to the surrounding elements.

Rexa Design donne vie à un espace salle de bain conçu pas seulement pour transmettre la tranquillité et le bien-être, mais aussi pour inspirer ceux qui la vivent. Tout cela se réalise par la présence d'objets qui caractérisent l'ambiance, en lui donnant de la personnalité. Rexa Design présente sa gamme complète de lavabos en îlot, qui combinent une expérience sensorielle avec la fonctionnalité, et s'imposent comme protagonistes de la salle de bain, en restant toujours connectés aux autres éléments de la salle de bain.

Rexa Design schafft ein Badezimmer, die nicht nur Ruhe und Wohlbefinden vermittelt, sondern auch die Menschen inspiriert. All dies geschieht durch das Vorhandensein von Objekten, die den Raum prägen und ihm Persönlichkeit verleihen. Rexa Design präsentiert sein komplettes Freestanding-Waschbeckenprogramm, welches Sinnlichkeit und Funktionalität kombiniert und sich als Protagonisten im Badezimmer aufdrängt, die aber nie aufhören, mit den umliegenden Elementen zu verhandeln.

Rexa Design da vida a un espacio de baño concebido no solo para transmitir serenidad y bienestar, sino también para inspirar a quienes lo viven. Todo esto se consigue gracias a la presencia de objetos que caracterizan el ambiente, dotándolo de personalidad. Rexa Design presenta su completo programa de lavabos a suelo, que combinan sensorialidad y funcionalidad, consolidándose como los protagonistas del baño, que sin embargo no deja de comunicarse con los elementos circundantes.

Overview



Smoking
P 06



O_O
P 16



Discovolante
P 28



Fonte totem
P 40



Fonte
P 44



Hole
P 50



Unico rotondo
P 54



Argo
P 58



Unico
P 62



Roll
P 68



Funnel
P 74

Smoking

design by Daniele Della Porta

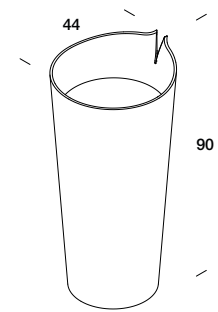

Lavabi a terra e sospesi

Smoking

6



7

Smoking

Freestanding and wall hung washbasins



Lavabo Smoking freestanding in Corian® Deep Nocturne Ø42x90h cm. Miscelatore a parete Drop nero opaco. Specchiera Filolucido 200x50h cm con illuminazione perimetrale a LED. Mensole contenitive a parete in lamiera nera opaca.

Smoking freestanding washbasin in Corian® Deep Nocturne Ø42x90h cm. Matt black wall-mounted mixer Drop. Filolucido mirror 200x50h cm with LED light. Black metal storage shelves.

Lavabo Smoking en îlot en Corian® Deep Nocturne Ø42x90h cm. Mitigeur a paroi Drop noir mat. Miroir Filolucido 200x50h cm avec éclairage LED. Étagères en métal noir mat.

Smoking Freestanding-Waschbecken aus Corian® Deep Nocturne Ø42x90h cm. Schwarz matt Drop Einbau-Wannenmischer. Filolucido Spiegel 200x50h cm mit LED Raumbelichtung. Schwarz matt Rückhalteregale aus Blech.

Lavabo Smoking a suelo en Corian® Deep Nocturne Ø42x90h cm. Mezclador a pared Drop en negro mate. Espejo Filolucido 200x50h cm con iluminación LED perimetral. Estantes a pared en lámina negra mate.

– Making of Smoking

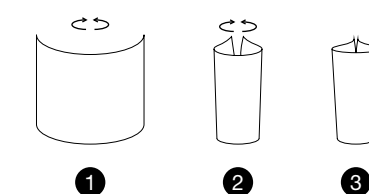

Smoking

design by Daniele Della Porta

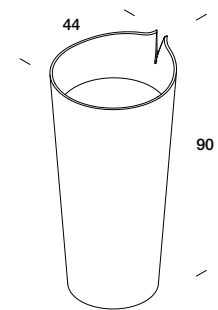

Lavabi a terra e sospesi

Smoking



Smoking

Freestanding and wall hung washbasins



Lavabo Smoking freestanding
 in Corian® Glacier White
 Ø42x90h cm con miscelatore
 Drop a parete nero opaco.
 Specchiera R1 contenitiva a
 incasso 90x12x70h cm.
 Appendini Moon Ø4 cm in Corian®
 Ash Aggregate e sgabello Fonte
 in frassino tinto olmo
 44x38x40h cm.

Smoking freestanding washbasin
 in Corian® Glacier White
 Ø42x90h cm with Drop black matt
 wall-mounted mixer. R1 recessed
 cabinet mirror 90x12x70h cm.
 Moon hooks Ø4 cm in Corian®
 Ash Aggregate and Fonte stool
 in wood 44x38x40h cm.

Lavabo Smoking en îlot en
 Corian® Glacier White Ø42x90h cm
 avec mitigeur Drop a paroi noir mat.
 Armoire miroir encastré R1
 90x12x70h cm. Crochet Moon
 Ø4 cm en Corian® Ash Aggregate
 et tabouret Fonte en bois
 44x38x40h cm.

Smoking Freestanding-
 Waschbecken aus Corian® Glacier
 White Ø42x90h cm mit schwarz
 matt Drop Einbau-Wannenmischer.
 R1 Einbau-Spiegel 90x12x70h cm.
 Moon Haken Ø4 cm aus Corian®
 Ash Aggregate und Fonte Hocker
 aus Eschenholz 44x38x40h cm.

Lavabo Smoking a suelo en Corian®
 Glacier White Ø42x90h cm con
 Mezclador Drop de pared negro
 mate. Espejo contenedor
 empotrado R1 90x12x70h cm.
 Perchas Moon Ø4 cm en Corian®
 Ash Aggregate Taburete Fonte en
 fresno pintado olmo 44x38x40h cm.

Smoking



A terra
Freestanding

Overview

a terra
 freestanding



Ø 42 P 44 H 90

Finiture | Finishes

Corian®



Miscelatori abbinabili | Combinable mixers

Mae

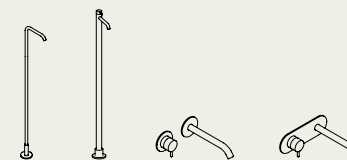

Drop



O_O

design by Bartoli Design

Lavabo O_O freestanding in marmo Carrara Ø50x90h cm.

O_O freestanding washbasin in Carrara marble Ø50x90h cm.

Lavabo O_O en ilôt en marbre Carrare Ø50 x 90h cm.

O_O Waschbecken aus Carrara Marmor Ø50x90h cm.

Lavabo O_O a suelo en marmol Carrara Ø50x90h cm.

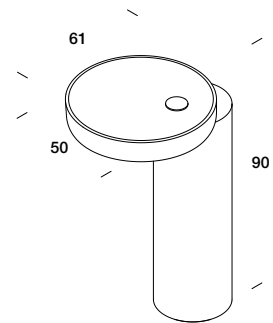



O_O

design by Bartoli Design

Lavabo O_O freestanding
in marmo Nero Marquinia
Ø50x90h cm con miscelatore
da piano Mae in Black Luxury.

O_O freestanding washbasin
in Nero Marquinia marble
Ø50x90h cm with Mae floor
mixer in Black Luxury.

Lavabo en ilôt en marbre noir
Marquinia Ø50x90h cm avec
mitigeur au sol Mae en
Black Luxury.

O_O Waschbecken aus Nero
Marquina Marmor Ø50x90h cm
mit Black Luxury Mae
Waschtischmischer.

Lavabo O_O a suelo en mármol
Nero Marquinia Ø50x90h cm
con Mezclador para lavabo
Mae en acero Black Luxury.

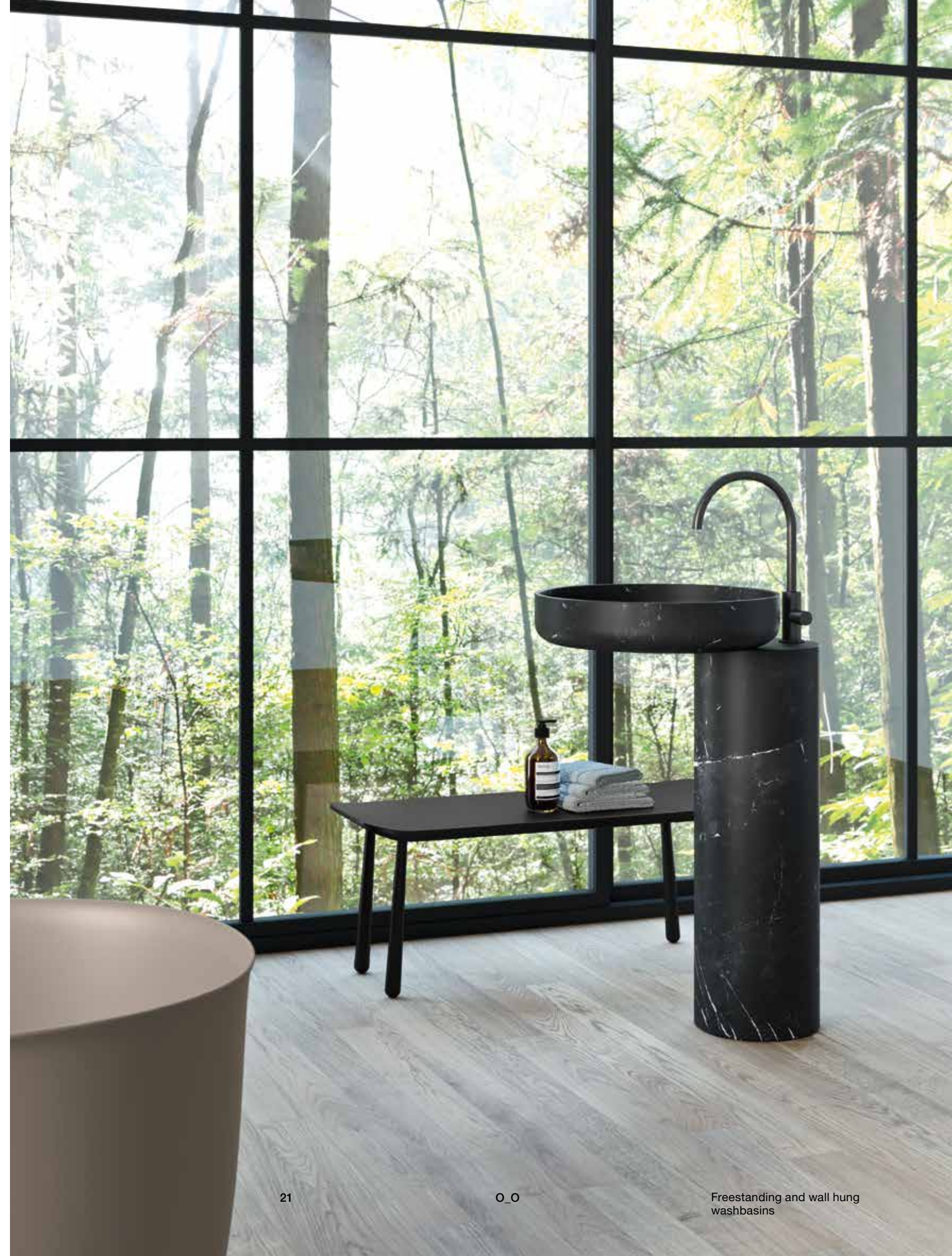
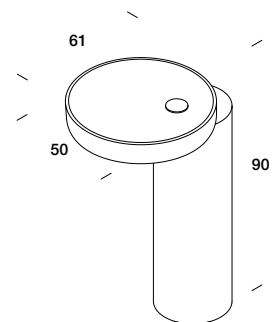

O_O

design by Bartoli Design

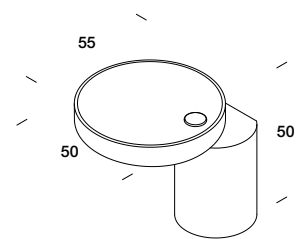

Lavabi a terra e sospesi

O_O

22



23

O_O

Freestanding and wall hung washbasins



Lavabo O_O sospeso in Corian®
Dune Prima con base in Glacier
White Ø50x50h cm e miscelatore
Mae da piano in Black Luxury.
Specchiera Halo Ø42 cm con
cornice in Corian® Deep Nocturne.
Portasalviette dedicato in acciaio
Inox satinato.

O_O suspended washbasin in
Corian® Dune Prima with base
in Glacier White Ø50x50h cm
and Mae deck mounted mixer
in Black Luxury.
Halo mirror Ø42 cm with frame
in Corian® Deep Nocturne.
Towel holder in brushed
stainless steel.

Lavabo O_O suspendu en Corian®
Dune Prima avec base en Glacier
White Ø50x50h cm et mitigeur
Mae en Black Luxury. Miroir Halo
Ø42 cm avec cadre en Corian®
Deep Nocturne. Porte-serviettes
en acier Inox satiné.

O_O Wand-Waschbecken aus
Corian® Dune Prima mit Basis
aus Glacier White Ø50x50h cm
und Black Luxury Mae
Waschtischmischer. Halo Spiegel
Ø42 cm mit Rahmen aus Corian®
Deep Nocturne. Handtuchhalter
aus Satin-Edelstahl.

Lavabo suspendido O_O de Corian®
Dune Prima con base en Glacier
White Ø50x50h cm y mezclador
para lavabo Mae en acero Black
Luxury. Espejo Halo Ø42 cm con
marco en Corian® Deep Nocturne.
Toallero dedicado en acero
inoxidable satinado.



Portasalviette
Towel rail



A terra
Freestanding



Sospeso
Wall hung

Overview

a terra
freestanding

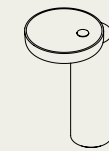

Ø 50 (lavabo | washbasin)
L 50 P 61 H 90

sospeso
wall hung

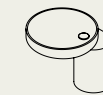

Ø 50 (lavabo | washbasin)
L 50 P 55 H 50

Finiture | Finishes

Corian®

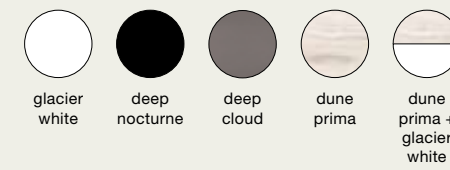

Marmo | Marble

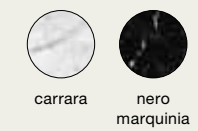

Accessori abbinabili | Combinable accessories



portasalviette
towel rail



appendino
hook

Miscelatori abbinabili | Combinable mixers

Mae

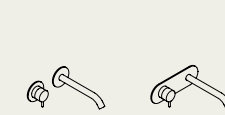

O_O

Drop



Freestanding and wall hung washbasins

Discovolante

design by Monica Graffeo

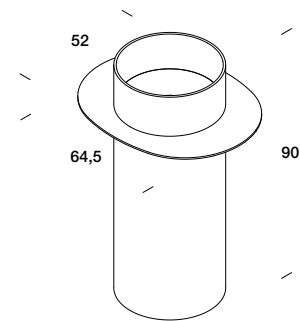

Lavabi a terra e sospesi

Discovolante

28

29

Discovolante

Freestanding and wall hung washbasins





Lavabo Discovolante in Corian® Deep Nocturne Ø37x90h cm con piano in vetro Grigio 64x52 cm e miscelatore Drop nero opaco. Specchiera Brame con cornice in vetro Grigio Ø 80 cm. Appendino dedicato in acciaio nero opaco.

Discovolante washbasin in Corian® Deep Nocturne Ø37x90hcm with Grey glass top 64x52 cm and matt black Drop mixer. Brame mirror with frame in Grey glass Ø80 cm. Hanger in black mat steel.

Lavabo Discovolante en Corian® Deep Nocturne Ø37x90h cm avec plan étagère en verre gris 64x52 cm et mitigeur Drop noir mat. Miroir Brame avec cadre en verre Gris Ø80 cm. Crochet en acier noir mat.

Discovolante Waschbecken aus Corian® Deep Nocturne Ø37x90h cm mit Regal aus graue Glas 64x52 cm und schwarz matt Drop Mischer. Brame Spiegel mit Rahmen aus graues Glas Ø 80 cm. Haken aus schwarz matt Edelstahl.

Lavabo Discovolante en Corian® Deep Nocturne Ø37x90h cm con encimera de vidrio Gris 64x52 cm y mezclador Drop negro mate. Espejos Brame con marco Vidrio Gris Ø 80 cm. Percha dedicada en acero negro opaco.



Discovolante

design by Monica Graffeo

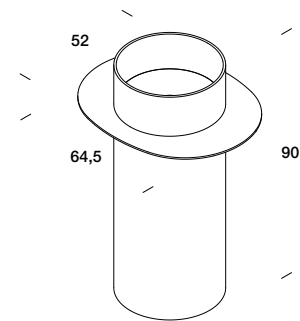

Lavabi a terra e sospesi

Discovolante

32



33

Discovolante

Freestanding and wall hung washbasins



Lavabo Discovolante in Corian®
Glacier White Ø37x90h cm con
piano in marmo Carrara 64x52 cm
e miscelatore Mae a parete satinato.
Specchiera Filolucido Ø 70 cm con
lampada Spin per specchiera
Ø 20 cm in Corian® Glacier White
con illuminazione a LED orientabile.

Discovolante washbasin in Corian®
Glacier White Ø37x90h cm with
Carrara marble top 64x52 cm
and Mae wall-mounted mixer in
brushed steel. Filolucido mirror
Ø70 cm with Spin lamp for mirror
20 cm in Corian® Glacier White
with adjustable LED lighting.

Lavabo Discovolante in Corian®
Glacier White Ø37x90h cm avec
Plan étagère en marbre Carrara
64x52 cm et Mae mitigeur à
paroi en acier brossé.
Miroir Filolucido Ø70 cm avec
lampe Spin pour miroir 20 cm
en Corian® Glacier White avec
éclairage LED orientable.

Discovolante Waschbecken aus
Corian® Glacier White Ø37x90h cm
mit Carrara Marmor Ablage
64x52 cm und Mae Satin-
Wandwaschtischmischer.
Filolucido Spiegel Ø 70 cm mit
Spin Lampe Ø 20 cm aus Corian®
Glacier White mit orientierbarer
LED Beleuchtung.

Lavabo Discovolante en Corian®
Glacier White Ø37x90h cm con
encimera de mármol Carrara
64x52 cm y mezclador Mae de
pared satinado. Espejo Filolucido
Ø 70 cm con lámpara Spin para
espejo Ø 20 cm en Corian®
Glacier White con iluminación
LED orientable.



Corian® Glacier White + Corian® Glacier White



Corian® Glacier White + Corian® Ash Aggregate



Corian® Deep Nocturne + Corian® Deep Nocturne



Corian® Deep Nocturne + Corian® Carbon Aggregate



Corian® Glacier White + Vetro bronzo / Bronze glass



Corian® Deep Nocturne + Marmo Nero Marquinia / Nero Marquinia marble



Portasalviette
Towel rail

Discovolante



A terra
Freestanding

Overview

a terra
freestanding

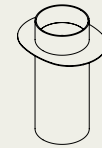

Ø 37 (lavabo | washbasin)
L 64,5 P 52 H 90

Finiture | Finishes

Corian® (Lavabo | Basin)



glacier white
deep nocturne

Corian® (Mensola | Shelf)



glacier white
deep nocturne
ash aggregate
carbon aggregate

Vetro | Glass (Mensola | Shelf)



bronzo
grigio

Marmo | Marble (Mensola | Shelf)

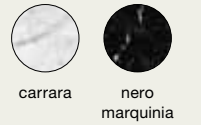

carrara
nero marquina

Accessori abbinabili | Combinable accessories



appendino
hook

Miscelatori abbinabili | Combinable mixers

Mae

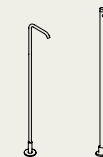

Discovolante

Drop



Freestanding and wall hung washbasins

Fonte totem

design by Monica Graffeo

Lavabo Fonte Totem freestanding 80x48x90h cm in Corian® Glacier White con miscelatore Drop nero opaco. Appendini Moon Ø 4 cm in Corian® Deep Nocturne. Lampada Arm a parete in vetro bianco e sgabello Fonte in frassino tinto olmo Ø 28x43h cm.

Fonte Totem freestanding washbasin 80x48x90h cm in Corian® Glacier White with matt black Drop mixer. Hangers Moon Ø 4 cm in Corian® Deep Nocturne. Arm wall lamp in white glass and Fonte stool in wood 28x43h cm.

Lavabo en ilòt Fonte Totem 80x48x90h cm en Corian® Glacier Blanc avec mitigeur Drop noir mat. Crochet Moon Ø 4 cm en Corian® Deep Nocturne. Lampe Arm à paroi en verre blanc et tabouret Fonte bois 28x43h cm.

Fonte Totem Freestanding-Waschbacken 80x48x90h cm aus Corian® Glacier White mit Schwarz matt Drop Mischer. Moon Hänger Ø 4 cm aus Corian® Deep Nocturne. Arm Wandlampe aus weiss Glas und Fonte Hocker aus Eschenholz Ø 28x43h cm.

Lavabo Fonte Totem a suelo 80x48x90h cm in Corian® Glacier White con mezclador Drop negro opaco. Percha Moon Ø 4 cm en Corian® Deep Nocturne. Lámpara Arm de pared en vidrio blanco y taburete Fonte en fresno pintado Olmo Ø 28x43h cm.

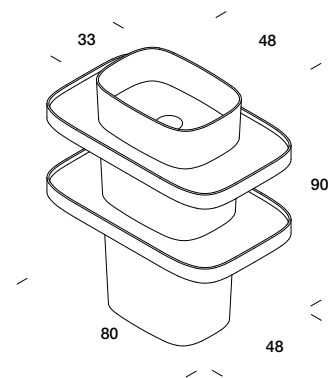



Fonte Totem



A terra
Freestanding



Sospeso
Wall hung

Overview

a terra
freestanding

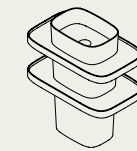

L 48 P 33 (lavabo | washbasin)
L 80 P 48 H 90

sospeso
wall hung

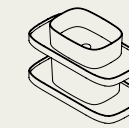

L 48 P 33 (lavabo | washbasin)
L 80 P 48 H 50

sospeso
wall hung

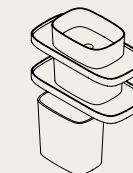

L 48 P 33 (lavabo | washbasin)
L 80 P 48 H 90

Finiture | Finishes

Corian®



glacier
white

Miscelatori abbinabili | Combinable mixers

Mae

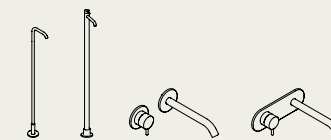

Drop



Fonte

design by Monica Graffeo

Lavabo Fonte freestanding in Corian® Glacier White 48x34x90h cm con miscelatore a terra Mae in acciaio Inox satinato. Specchiera Filolucido 90x200h cm e lampada Metrolineare nera L 120 cm. Appendino in faggio naturale.

Fonte freestanding washbasin in Corian® Glacier White 48x34x90h cm with floorstanding mixer Mae in brushed stainless steel. Filolucido mirror 90x200h cm and Metrolineare black light L 120 cm. Hanger in wood.

Lavabo Fonte en îlot en Corian® Glacier White 48x34x90h cm avec mitigeur Mae au sol en acier satiné. Miroir Filolucido 90x200h cm et lampe Metrolineare noire L 20 cm. Crochet en bois.

Fonte Freestanding-Washbecken aus Corian® Glacier White 48x34x90h cm mit Mae bodenstehender Waschtischmischer aus Satin-Edelstahl. Filolucido Spiegel 90x200h cm und schwarze Metrolineare Lamp L 120 cm. Haken aus Buchenholz.

Lavabo Fonte indipendente en Corian® Glacier White 48x34x90h cm con mezclador a suelo Mae en acero inoxidable satinado. Espejo Filolucido 90x200h cm y la lámpara Metrolineare negro L 120 cm. Percha en haya natural.

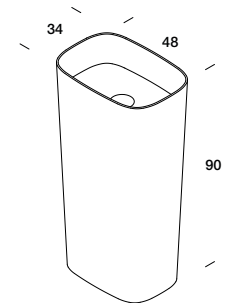



Appendino
Hook

Fonte



A terra
Freestanding



Sospeso
Wall hung



Sospeso con cassetto
Wall hung with drawer

Overview

a terra
freestanding



L 48 P 34 H 90

sospeso
wall hung

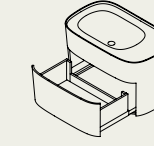
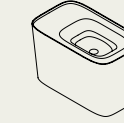
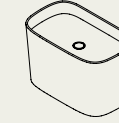

L 80 P 48 H 50

Finiture | Finishes

* Disponibile solo per Fonte a terra | Available only for freestanding Fonte

Corian®



glacier
white



deep
nocturne*

Accessori abbinabili | Combinable accessories



appendino
hook

Miscelatori abbinabili | Combinable mixers

Mae

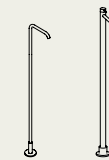

Drop



Hole

design by Susanna Mandelli

Lavabo Hole freestanding in Corian® Glacier White Ø 41x90h cm con interno in Corian® Deep Nocturne e miscelatore Mae a parete in Black Luxury.

Hole freestanding washbasin in Corian® Glacier White Ø41x90h cm with inside part in Corian® Deep Nocturne and Mae wall-mounted mixer in Black Luxury.

Lavabo Hole en îlot en Corian® Glacier White Ø 41x90h cm avec partie interne en Corian® Deep Nocturne et mitigeur Mae a paroi en Black Luxury.

Hole Freestanding-Waschbecken aus Corian® Glacier White Ø 41x90h cm mit Innenseite aus Corian® Deep Nocturne und Mae Black Luxury Wandwaschtischmischer.

Lavabo Hole a suelo in Corian® Glacier White Ø 41x90h cm con Interior en Corian® Deep Nocturne y mezclador Mae a pared en Black Luxury.

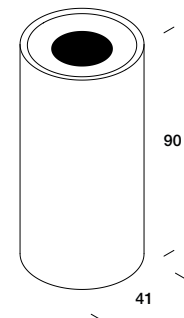



Hole



A terra
Freestanding



Sospeso
Wall hung

Overview

a terra
freestanding



Ø 41 H 90

sospeso
wall hung



Ø 41 H 50

Finiture | Finishes

Corian®



glacier
white +
deep
nocturne

Miscelatori abbinabili | Combinable mixers

Mae

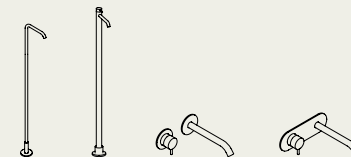

Drop



Unico rotondo

design by Rexa Design Studio

Lavabo Unico rotondo freestanding in Corian® Deep Nocturne Ø41x90h cm con miscelatore a terra Mae in acciaio Inox satinato. Specchiera Halo Ø72 cm con cornice in Corian® Deep Nocturne.

Unico Rotondo freestanding washbasin in Corian® Deep Nocturne Ø41x90h cm with Mae floorstanding mixer in brushed stainless steel. Halo mirror Ø72 cm with frame in Corian® Deep Nocturne.

Lavabo Unico Rotondo en îlot en Corian® Deep Nocturne Ø41x90h cm avec mitigeur au sol Mae en acier satiné. Miroir Halo Ø72 cm avec cadre en Corian® Deep Nocturne.

Unico rotondo Freestanding-Waschbecken aus Corian® Deep Nocturne Ø41x90h cm mit Mae bodenstehender Waschtischmischer aus Satin-Edelstahl. Halo Spiegel Ø72 cm mit Rahmen aus Corian® Deep Nocturne.

Lavabo Único redondo a suelo en Corian® Deep Nocturne Ø41x90h cm con mezclador a suelo Mae en acero inoxidable satinado. Espejo Halo Ø72 cm con marco en Corian® Deep Nocturne.

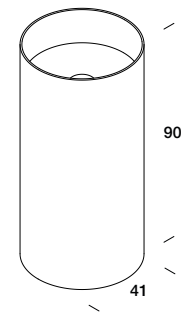



Unico rotondo



A terra
Freestanding



Sospeso
Wall hung

Overview

a terra
freestanding



Ø 41 H 90

sospeso
wall hung



Ø 41 H 50

Finiture | Finishes

Corian®



Accessori abbinabili | Combinable accessories



appendino
hook

Miscelatori abbinabili | Combinable mixers

Mae



Drop

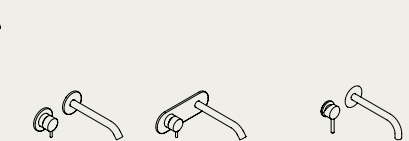

Argo

design by Imago Design

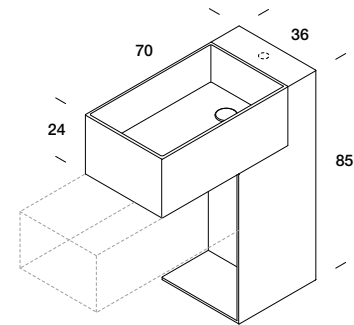

Lavabi a terra e sospesi

Argo



Argo

Freestanding and wall hung washbasins



Lavabo Argo freestanding in Corian® Silver Grey 70x36x85h cm con cassetto in accosto in Corian® Deep Nocturne con frontale in Eucalipto 70x36x24h cm. Specchiera Filolucido 70x90h cm.

Argo freestanding washbasin in Corian® Silver Grey 70x36x85h cm with drawer in Corian® Deep Nocturne with front door in Eucalyptus 70x36x24h cm. Filolucido mirror 70x90h cm.

Lavabo Argo en îlot en Corian® Silver Grey 70x36x85h cm avec tiroir en Corian® Deep Nocturne avec façade en eucalyptus 70x36x24h cm. Miroir Filolucido 70x90h cm.

Argo Freestanding-Waschbecken aus Corian® Silver Grey 70x36x85h cm mit Schublade aus Corian® Deep Nocturne mit Vorderseite aus Eucalypto 70x36x24h cm. Filolucido Spiegel 70x90h cm.

Lavabo Argo a suelo en Corian® Silver Grey 70x36x85h cm con cajón en el lado de Corian® Deep Nocturne con frontal Eucalipto 70x36x24h cm. Espejo Filolucido 70x90h cm.

Argo



A terra
Freestanding



Sospeso
Wall hung

Overview

a terra
freestanding
— dx / sx

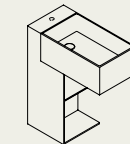

L 70 P 36 H 85

sospeso
wall hung
— dx / sx

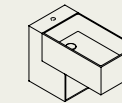

L 70 P 36 H 48

cassetto
drawer

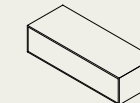

L 70 P 36 H 24

Scocca: Corian®
Frontale: Corian® / legno
Carcase: Corian®
Frontal: Corian® / wood

Finiture | Finishes

Corian® (lavabo e cassetto | washbasin and drawer)



Legno | Wood (frontale | frontal)



Miscelatori abbinabili | Combinable mixers

Mae

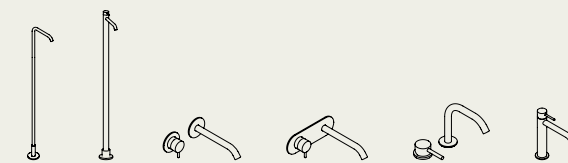

61

Drop



Argo

Freestanding and wall hung washbasins

Unico

design by Rexa Design Studio

Lavabo Unico freestanding con pianetto interno laterale ribassato 50x36x85h cm in Corian® Dune Prima. Miscelatore Mae a parete in acciaio Inox satinato. Specchiera Filolucido 50x80h cm con lampada Spin in Corian® Dune Prima 20x40h cm con illuminazione a led orientabile. Appendini Stone nello stesso materiale.

Unico freestanding washbasin with internal shelf 50x36x85h cm in Corian® Dune Prima. Mae wall-mounted mixer in brushed stainless steel. Filolucido mirror 50x80h cm with Spin lamp in Corian® Dune Prima 20x40h cm and adjustable led lighting. Stone hangers in the same material.

Lavabo Unico en îlot avec Tablette interne 50x36x85h cm en Corian® Dune Prima. Mitigeur Mae à paroi en acier satiné. Miroir Filolucido 50x80h cm avec lampe Spin in Corian® Dune Prima 20x40h cm et éclairage led orientable. Crochet Stone dans le même matériau.

Unico Freestanding-Waschbecken mit abgesenkt seitliche innere Ebene 50x36x85h cm aus Corian® Dune Prima. Mae Wandwaschtischmischer. Aus Satin-Edenstahl. Filolucido Spiegel 50x80h cm mit Spin Lampe aus Corian® Dune Prima 20x40h cm mit orientierbarer LED Beleuchtung. Stone Haken aus demselben Material.

Lavabo Único a suelo con estante lateral rebajado 50x36x85h cm en Corian® Dune Prima. Mezclador a pared Mae en acero inoxidable satinado. Espejo Filolucido 50x80h cm con lámpara LED Spin en Corian® Dune Prima 20x40h cm con iluminación orientable. Perchas Stone en el mismo material.

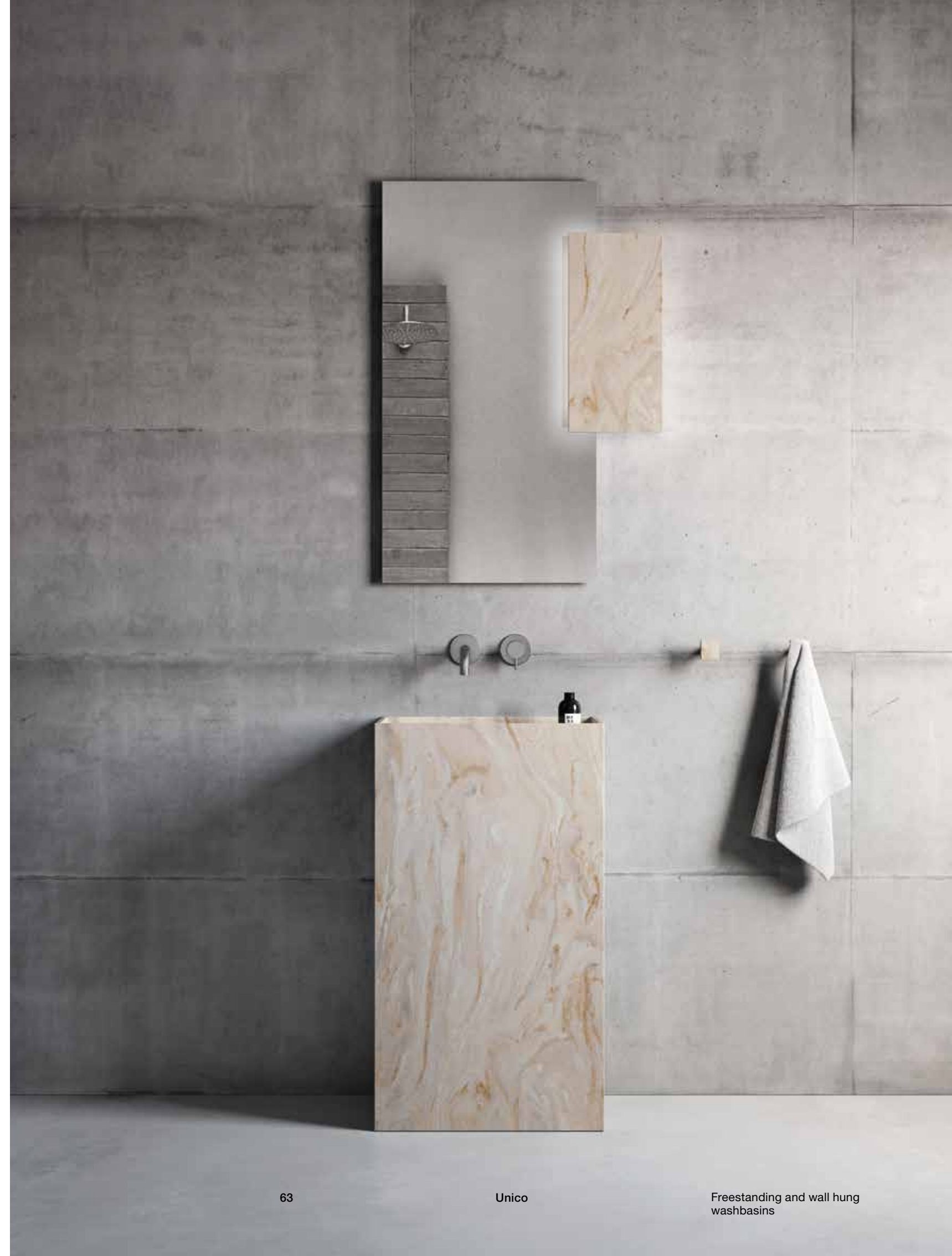
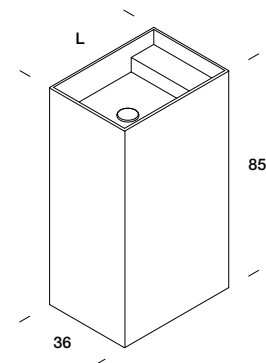



Unico



A terra
Freestanding



Sospeso
Wall hung

Overview

a terra
freestanding

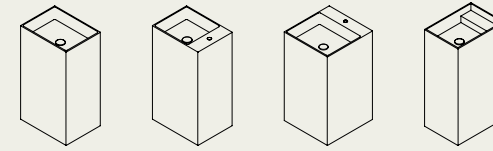

L 50-60 P 36-46 H 85



sospeso
wall hung

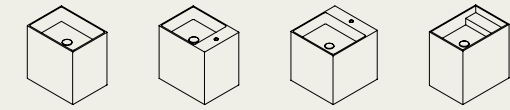

L 50-60 P 36-46 H 50



Finiture | Finishes

Corian®

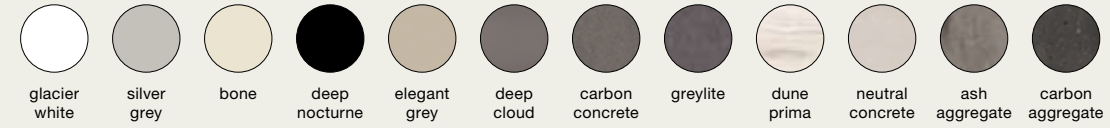

Accessori abbinabili | Combinable accessories



appendino
hook

Miscelatori abbinabili | Combinable mixers

Mae

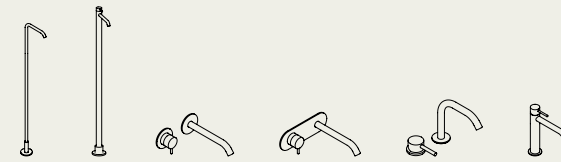

Drop



Roll

Doppio lavabo Roll Ø 46x90h cm in marmo Nero Marquinia con doppia specchiera Reflex 90x5x72,5h cm con specchio Grigio ed illuminazione a LED perimetrale esterna. Appendini Moon in Corian® Deep Nocturne.

Double Roll washbasin Ø46x90h cm in black Marquinia marble with double mirror Reflex 90x5x72,5h cm with grey mirror and LED lighting. Moon hangers in Corian® Deep Nocturne.

Double lavabo Roll Ø46x90h cm en marbre noir Marquinia avec double miroir Reflex 90x5x72,5h cm, avec miroir gris et éclairage LED. Crochets Moon en Corian® Deep Nocturne.

Roll Doppel-Waschbecken Ø46x90h cm aus Nero Marquinia Marmor mit Reflex Doppel-Spiegel 90x5x72,5h cm mit grauem Spiegel und LED Raumbelichtung. Moon Haken aus Corian® Deep Nocturne.

Doble lavabo Roll Ø46x90h cm en mármol Negro Marquinia con doble espejo Reflex 90x5x72,5h cm con espejo Gris e iluminación a LED perimetral exterior. Perchas Moon en Corian® Deep Nocturne.

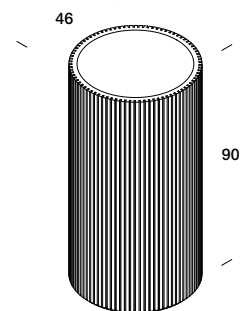

Lavabi a terra e sospesi

Roll





A. Specchiera Reflex
90-120-140-160x72,5h cm
con specchio Grigio.
B. Specchiera Reflex
90-120-140-160x72,5h cm
con specchio Bronzo.

A. A. Reflex mirror
90-120-140-160x72,5h cm
with grey mirror.
B. Reflex mirror
90-120-140-160x72,5h
with bronze mirror.

A. Miroir Reflex
90-120-140-160x72,5h cm
Avec miroir gris.
B. Miroir Reflex
90-120-140-160x72,5h
avec miroir bronze.

A. Reflex Spiegel
90-120-140-160x72,5h cm
mit grauen Spiegel.
B. Reflex Spiegel
90-120-140-160x72,5h
mit bronze Spiegel.

A. Espejo Reflex
90-120-140-160x72,5h cm
con espejo gris.
B. Espejo Reflex
90-120-140-160x72,5h
con espejo bronze.



L 90-120 cm

L 140-160 cm

Roll



A terra
Freestanding

Overview

a terra
freestanding

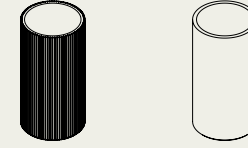

Ø 46 H 90

Finiture | Finishes

Marmo | Marble

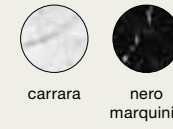

carrara

nero
marquina

Miscelatori abbinabili | Combinable mixers

Mae

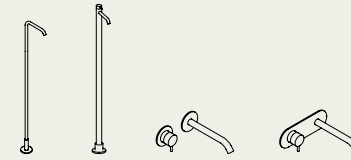

Drop



Funnel

Lavabo Funnel Ø 45x90h cm in marmo Carrara e specchiera Halo Ø 72 cm con cornice in Corian® Deep Nocturne.
Mensola e portasalviette Moon in Corian® Deep Nocturne.

Funnel washbasin Ø45x90h cm in Carrara marble and Halo mirror Ø72 cm with frame in Corian® Deep Nocturne. Shelf and towel holder Moon in Corian® Deep Nocturne.

Lavabo Funnel Ø45x90h cm en marbre Carrara et miroir Halo Ø72 cm avec cadre en Corian® Deep Nocturne. Porte-serviette et étagère Moon en Corian® Deep Nocturne.

Funnel Waschbecken Ø45x90h cm aus Carrara Marmor und Halo Spiegel Ø72 cm mit Rahmen aus Corian® Deep Nocturne. Moon Regal und Handtuchhalter aus Corian® Deep Nocturne.

Lavabo Funnel Ø45x90h cm en mármol Carrara y espejo Halo Ø72 cm con marco en Corian® Deep Nocturne. Estante y toallero Moon en Corian® Deep Nocturne.

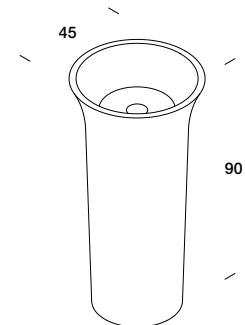



Funnel



A terra
Freestanding

Overview

a terra
freestanding



Ø 45 H 90

Finiture | Finishes

Marmo | Marble

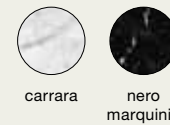

carrara nero
marquina

Miscelatori abbinabili | Combinable mixers

Mae

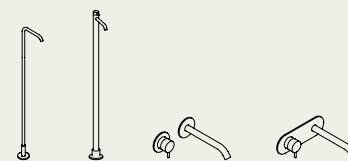

Drop





Spin

Lampada a parete con illuminazione a led orientabile
Wall hung lamp with adjustable led lighting

Dimensioni | Dimensions
L 20 H 40 - L 20 H 20

Finiture | Finishes
Corian®

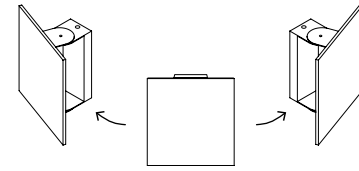

Spin

Lampada a parete con illuminazione a led orientabile
Wall hung lamp with adjustable led lighting

Dimensioni | Dimensions
Ø 20

Finiture | Finishes
Corian®

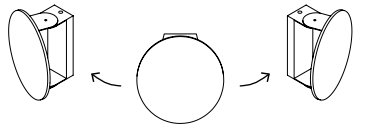

Informazioni tecniche

Technical informations | Informations techniques | Technische Informationen | Información técnica

Smoking

Dimensioni | Dimensions

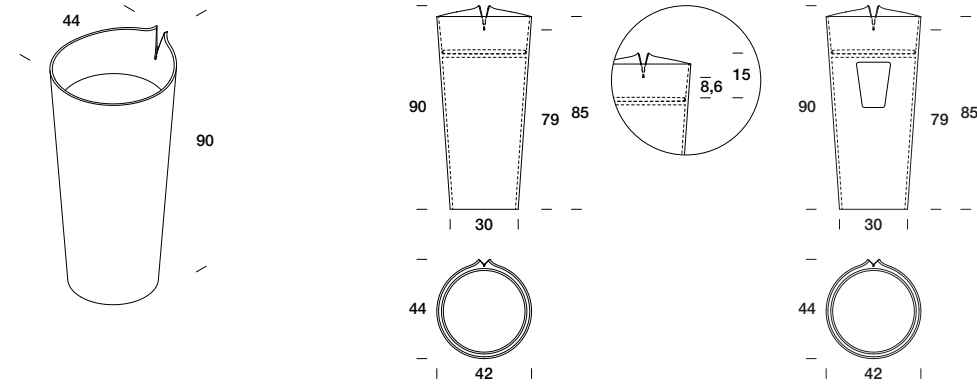

Design by **Daniele Della Porta**

Piletta nascosta scarico libero inclusa, sifone escluso | Free hidden drain included, siphon not included | Bonde caché à écoulement libre inclus, siphon non compris | Versteckt Ablaufgarnitur inklusiv, Siphon ausgeschlossen | Desagüe oculto libre incluido, sifón excluido

Installazione | Installation

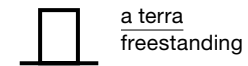

Rubinetteria | Faucet

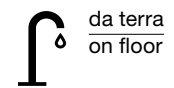
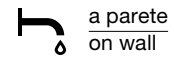

Scarico | Drain

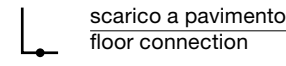
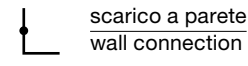

Pesi e volumi | Weight and volume

Kg	Kg	M³
32	42	0,23

Corian®



O_0

Dimensioni | Dimensions

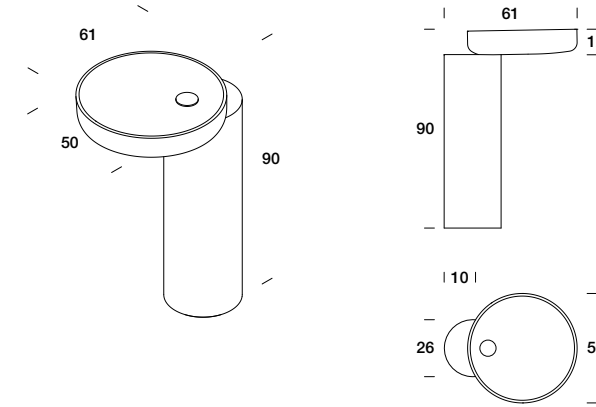

Design by **Bartoli Design**

Piletta sporgente scarico libero inclusa, sifone escluso | Free protruding drain included, siphon not included | Bonde proéminent à écoulement libre inclus, siphon non compris | Hervorstehender Ablaufgarnitur inklusiv, Siphon ausgeschlossen | Desagüe libre que sobrasale incluido, sifón excluido

Installazione | Installation

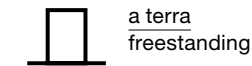

Rubinetteria | Faucet

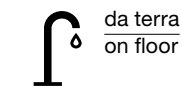
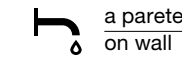

Scarico | Drain

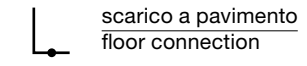

Pesi e volumi | Weight and volume

Corian®		
Kg	Kg	M³
32	82	0,43

Marmo Marble		
Kg	Kg	M³
70	120	0,43

Corian®



Marmo | Marble



Dimensioni | Dimensions

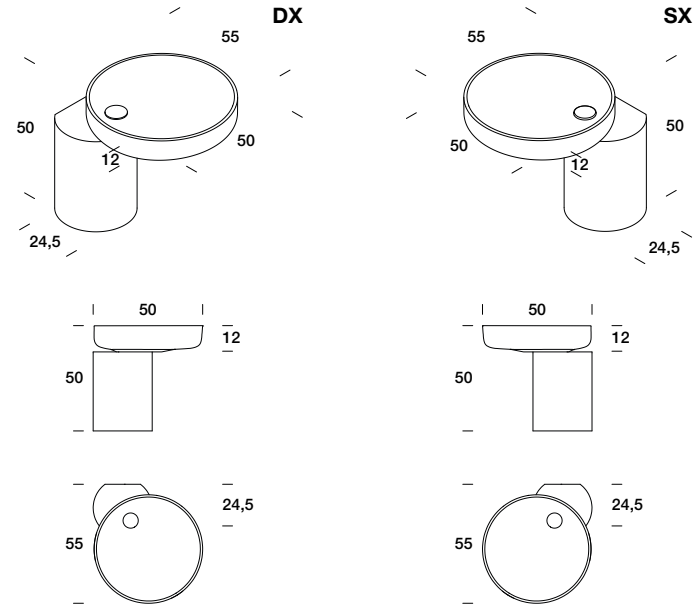

Design by Bartoli Design

Piletta sporgente scarico libero inclusa, sifone escluso | Free protruding drain included, siphon not included | Bonde proéminent à écoulement libre inclus, siphon non compris | Hervorstehender Ablaufgarnitur inklusiv, Siphon ausgeschlossen | Desagüe libre que sobrasale incluido, sifón excluido

Installazione | Installation

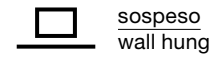

Rubinetteria | Faucet

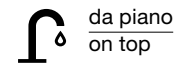
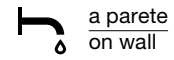

Scarico | Drain

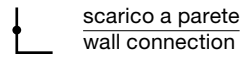

Pesi e volumi | Weight and volume

Corian®

Kg	Kg	M³
24	74	0,21

Marmo | Marble

Kg	Kg	M³
43	93	0,21

Corian®



Marmo | Marble

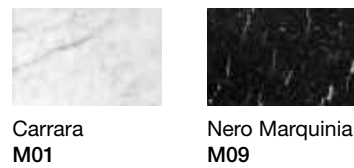

O_O accessories | O_O accessoires | O_O Zubehören | O_O accessorios

Portasalviette | Towel rail



Acciaio Inox | Stainless steel



spazzolato brushed

Discovolante

Dimensioni | Dimensions

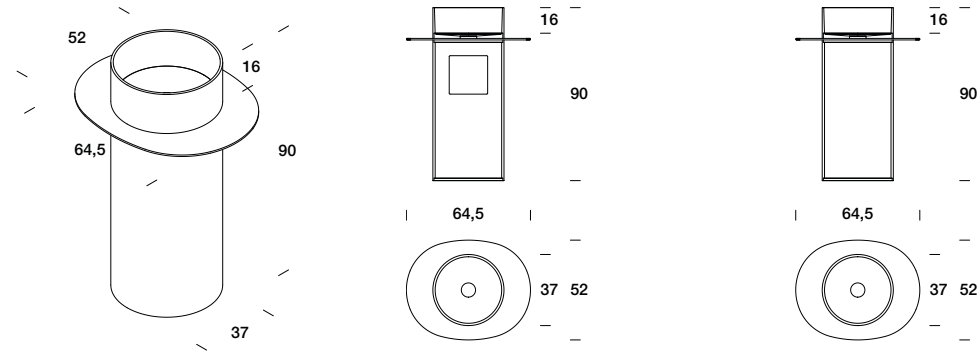

Design by **Monica Graffeo**

Piletta a filo scarico libero inclusa, sifone escluso | Free flush flow drain included, siphon not included | Bonde au ras à écoulement libre inclus, siphon non compris | Bündig Ablaufgarnitur inklusiv, Siphon ausgeschlossen | Desagüe libre alineado incluido, sifón excluido

Installazione | Installation

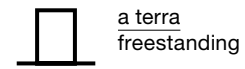

Rubinetteria | Faucet

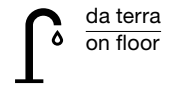
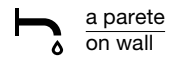

Scarico | Drain

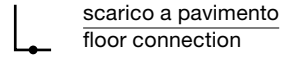
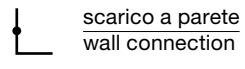

Pesi e volumi | Weight and volume

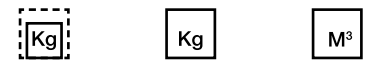

32 45 0,48

Corian® (Lavabo | Washbasin)



Glacier White
C01 Deep Nocturne
C38

Corian® (Mensola | Shelf)



Ash Aggregate
C45 Carbon Aggregate
C46

Marmo | Marble (Mensola | Shelf)



Carrara
M01 Nero Marquinia
M09

Vetro | Glass (Mensola | Shelf)



Bronzo Grigio

Accessori Discovolante

Discovolante accessories | Discovolante accessoires | Discovolante Zubehören | Discovolante accessorios

Appendino | Hook



Ø 7
H 5,2

Acciaio | Steel



Nero
Black

Fonte Totem

Dimensioni | Dimensions

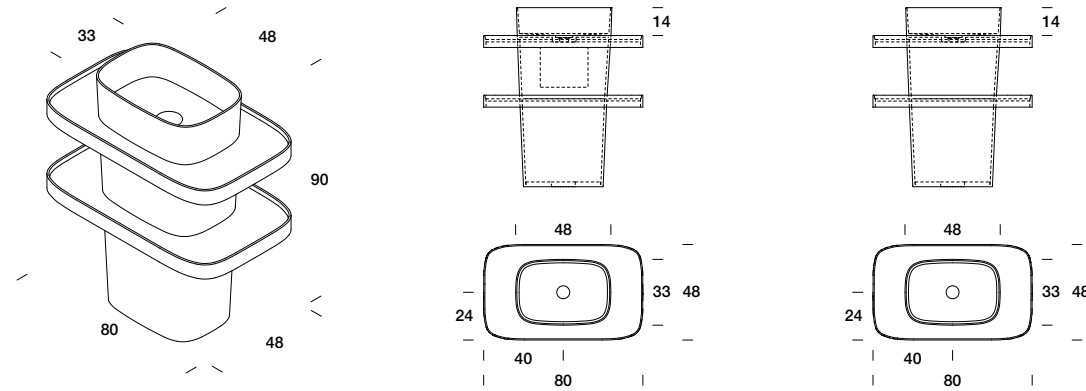

Design by **Monica Graffeo**

Piletta a filo scarico libero inclusa, sifone escluso | Free flush flow drain included, siphon not included | Bonde au ras à écoulement libre inclus, siphon non compris | Bündig Ablaufgarnitur inklusiv, Siphon ausgeschlossen | Desagüe libre alineado incluido, sifón excluido

Installazione | Installation

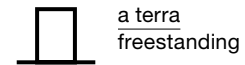

a terra
freestanding

Rubinetteria | Faucet

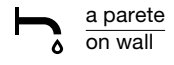

a parete
on wall



da piano
on top

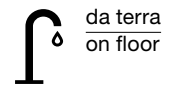

da terra
on floor

Scarico | Drain

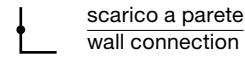

scarico a parete
wall connection

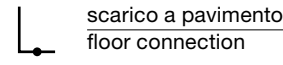

scarico a pavimento
floor connection

Pesi e volumi | Weight and volume

Kg	Kg	M³
47	57	0,59

Corian®

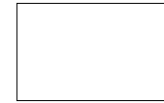

Glacier White
C01

Fonte Totem sospeso

Wall hung Fonte Totem | Fonte Totem suspendu | Fonte Totem an Wand | Fonte Totem suspendidos

Dimensioni | Dimensions

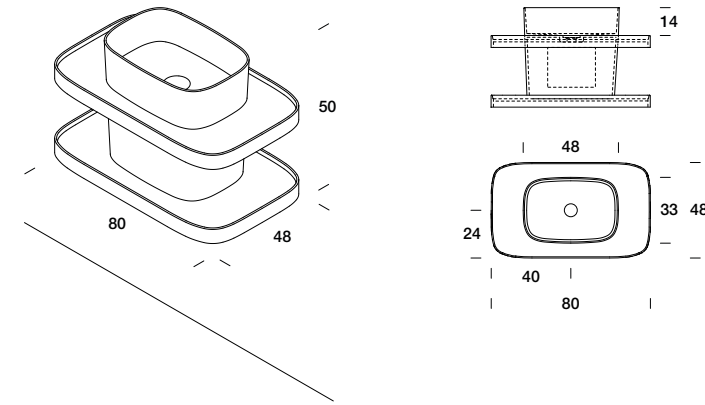

Design by **Monica Graffeo**

Piletta a filo scarico libero inclusa, sifone escluso | Free flush flow drain included, siphon not included | Bonde au ras à écoulement libre inclus, siphon non compris | Bündig Ablaufgarnitur inklusiv, Siphon ausgeschlossen | Desagüe libre alineado incluido, sifón excluido

Installazione | Installation



sospeso
wall hung

Rubinetteria | Faucet

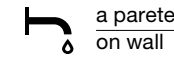

a parete
on wall



da piano
on top



da terra
on floor

Scarico | Drain

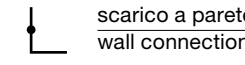

scarico a parete
wall connection

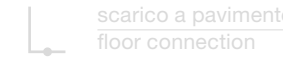

scarico a pavimento
floor connection

Pesi e volumi | Weight and volume

Kg	Kg	M³
28,5	38,5	0,31

Corian®



Glacier White
C01

Fonte Totem sospeso con cesto mobile

Fonte Totem with removable basket | Fonte Totem avec panier amovible | Fonte Totem mit abnehmbare Wäschekorb | Fonte Totem con cesto extraible

Dimensioni | Dimensions

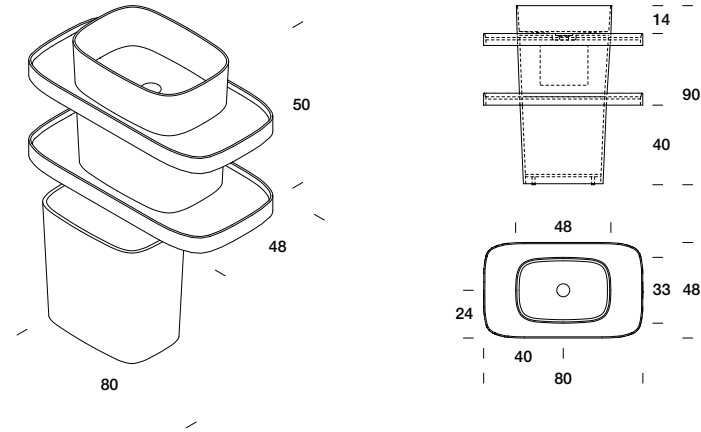

Design by **Monica Graffeo**

Piletta a filo scarico libero inclusa, sifone escluso | Free flush flow drain included, siphon not included | Bonde au ras à écoulement libre inclus, siphon non compris | Bündig Ablaufgarnitur inklusiv, Siphon ausgeschlossen | Desagüe libre alineado incluido, sifón excluido

Installazione | Installation

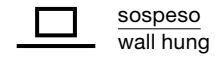

sospeso
wall hung

Rubinetteria | Faucet

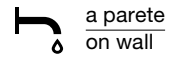

a parete
on wall



da piano
on top

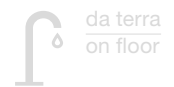

da terra
on floor

Scarico | Drain

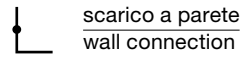

scarico a parete
wall connection



scarico a pavimento
floor connection

Pesi e volumi | Weight and volume

Kg	Kg	M³
47	57	0,59

Corian®



Glacier White
C01

Fonte

Dimensioni | Dimensions

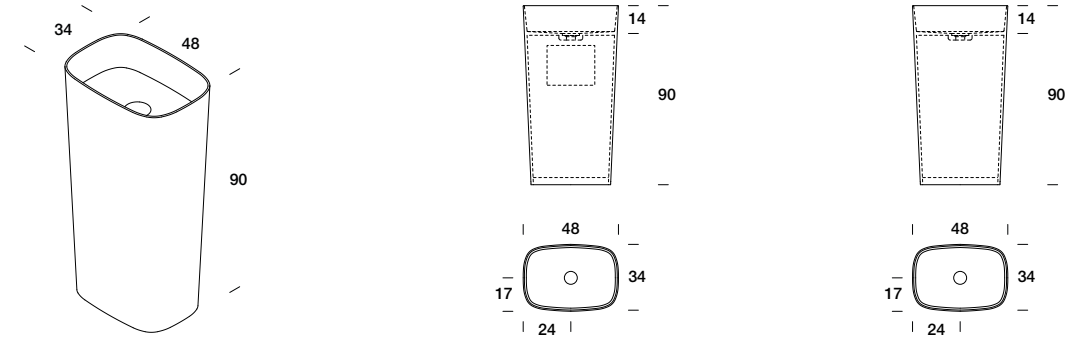

Design by **Monica Graffeo**

Piletta a filo scarico libero inclusa, sifone escluso | Free flush flow drain included, siphon not included | Bonde au ras à écoulement libre inclus, siphon non compris | Bündig Ablaufgarnitur inklusiv, Siphon ausgeschlossen | Desagüe libre alineado incluido, sifón excluido

Installazione | Installation

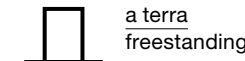

a terra
freestanding

Rubinetteria | Faucet

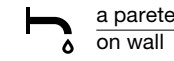

a parete
on wall



da piano
on top

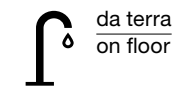

da terra
on floor

Scarico | Drain

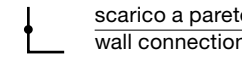

scarico a parete
wall connection

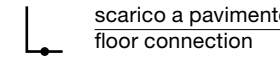

scarico a pavimento
floor connection

Pesi e volumi | Weight and volume

Kg	Kg	M³
32	42	0,2

Corian®



Glacier White
C01

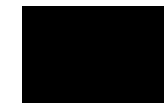

Deep Nocturne
C38

Fonte sospeso termoformato

Wall hung thermoformed Fonte | Fonte thermoformé suspendu | Fonte thermogeformt an Wand | Fonte termoformado suspendido

Dimensioni | Dimensions

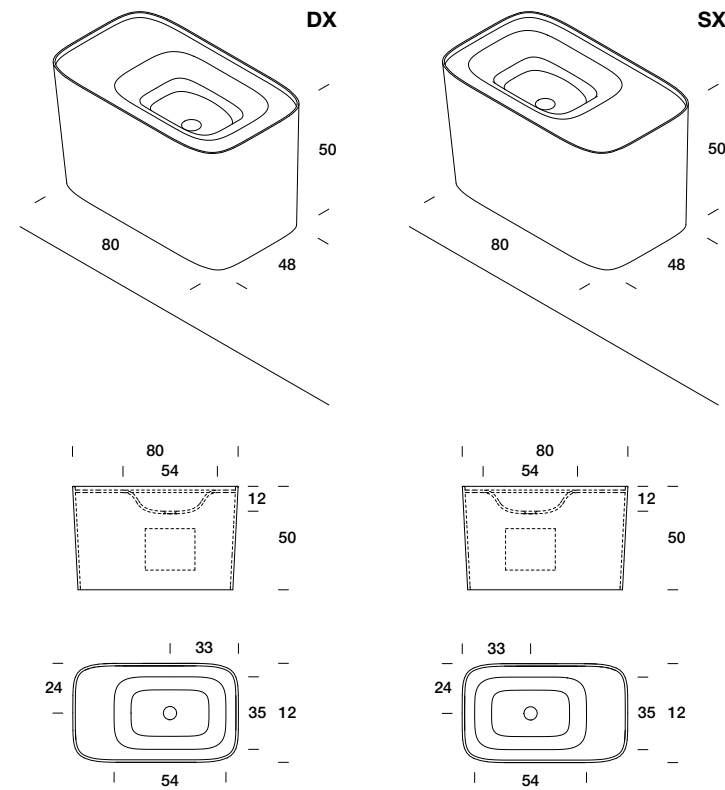

Design by Monica Graffeo

Piletta sporgente scarico libero inclusa, sifone escluso | Free protruding drain included, siphon not included | Bonde proéminent à écoulement libre inclus, siphon non compris | Hervorstehender Ablaufgarnitur inklusiv, Siphon ausgeschlossen | Desagüe libre que sobrasale incluido, sifón excluido

Installazione | Installation



Rubinetteria | Faucet

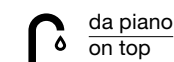
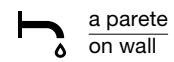

Scarico | Drain

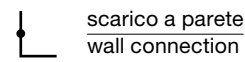

Pesi e volumi | Weight and volume

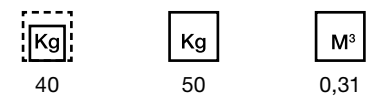

Corian®



Glacier White
C01

Fonte sospeso termoformato con cassetto

Wall hung thermoformed Fonte with drawer | Fonte thermoformé suspendu avec tiroir | Fonte thermogeformt an Wand mit Schublade | Fonte termoformado suspendido con cajon

Dimensioni | Dimensions

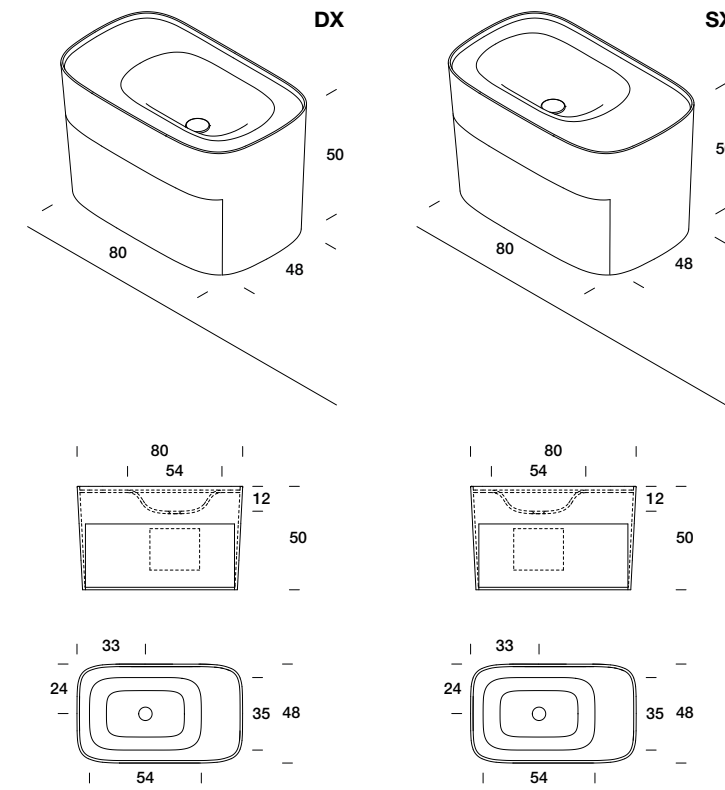

Design by Monica Graffeo

Piletta sporgente scarico libero inclusa, sifone escluso | Free protruding drain included, siphon not included | Bonde proéminent à écoulement libre inclus, siphon non compris | Hervorstehender Ablaufgarnitur inklusiv, Siphon ausgeschlossen | Desagüe libre que sobrasale incluido, sifón excluido

Installazione | Installation



Rubinetteria | Faucet

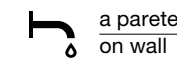

Scarico | Drain

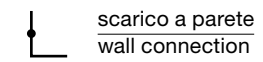

Pesi e volumi | Weight and volume

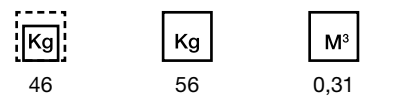

Corian®



Glacier White
C01

Fonte sospeso

Wall hung Fonte | Fonte suspendu | Fonte an Wand | Fonte suspendido

Dimensioni | Dimensions

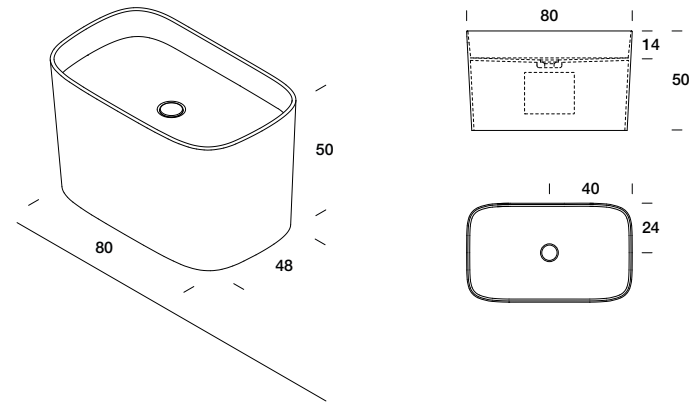

Design by **Monica Graffeo**

Piletta a filo scarico libero inclusa, sifone escluso | Free flush flow drain included, siphon not included | Bonde au ras à écoulement libre inclus, siphon non compris | Bündig Ablaufgarnitur inklusiv, Siphon ausgeschlossen | Desagüe libre alineado incluido, sifón excluido

Installazione | Installation



sospeso
wall hung

Rubinetteria | Faucet

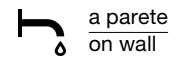

a parete
on wall



da piano
on top



da terra
on floor

Scarico | Drain

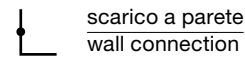

scarico a parete
wall connection



scarico a pavimento
floor connection

Pesi e volumi | Weight and volume

Kg	Kg	M³
37	47	0,31

Corian®

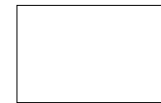

Glacier White
C01

Hole

Dimensioni | Dimensions

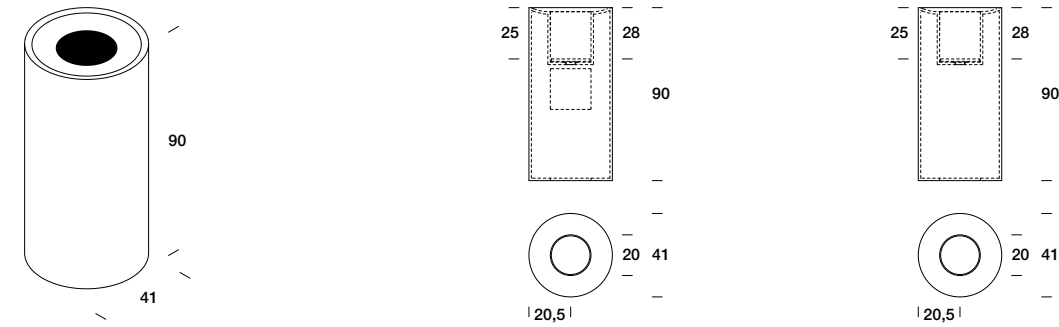

Design by **Susanna Mandelli**

Piletta a scarico libero inclusa, sifone escluso | Free flush flow drain included, siphon not included | Bonde au ras à écoulement libre inclus, siphon non compris | Bündig Ablaufgarnitur inklusiv, Siphon ausgeschlossen | Desagüe libre alineado incluido, sifón excluido

Installazione | Installation



a terra
freestanding

Rubinetteria | Faucet

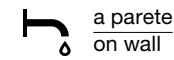

a parete
on wall



da piano
on top

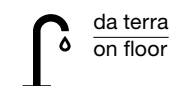

da terra
on floor

Scarico | Drain

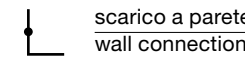

scarico a parete
wall connection

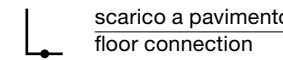

scarico a pavimento
floor connection

Pesi e volumi | Weight and volume

Kg	Kg	M³
33,2	43,2	0,25

Corian®



Glacier White
C01 +
Deep Nocturne
C38



Deep Nocturne

Glacier White

Hole sospeso

Wall hung Hole | Hole suspendu | Hole an Wand | Hole suspendido

Dimensioni | Dimensions

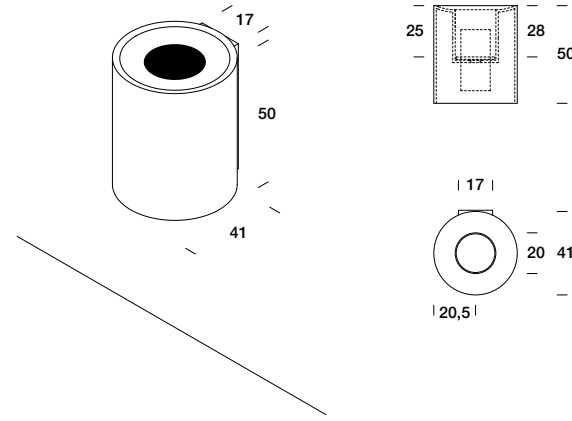

Design by Susanna Mandelli

Piletta a scarico libero inclusa, sifone escluso | Free flush flow drain included, siphon not included | Bonde au ras à écoulement libre inclus, siphon non compris | Bündig Ablaufgarnitur inklusiv, Siphon ausgeschlossen | Desagüe libre alineado incluido, sifón excluido

Installazione | Installation

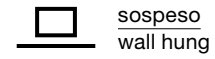

Rubinetteria | Faucet

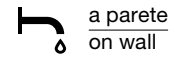

Scarico | Drain

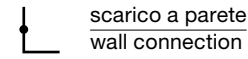

Pesi e volumi | Weight and volume

Kg	Kg	M³
20,2	30,2	0,15

Corian®



Glacier White
C01 +
Deep Nocturne
C38

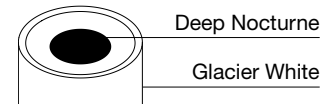

Unico Rotondo

Dimensioni | Dimensions

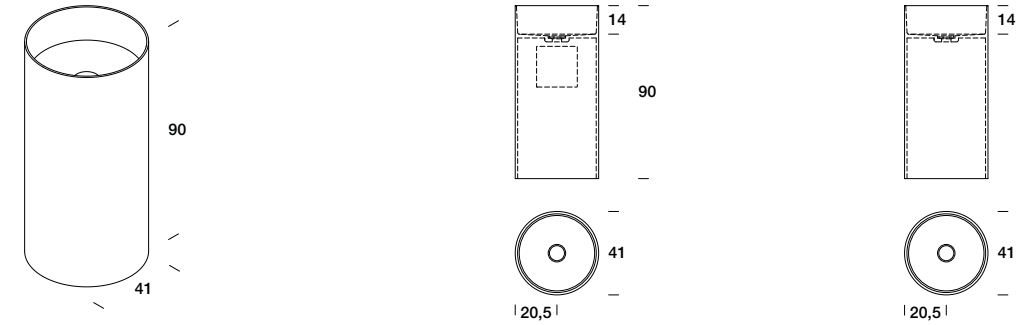

Design by Rexa Design Studio

Piletta a filo scarico libero inclusa, sifone escluso | Free flush flow drain included, siphon not included | Bonde au ras à écoulement libre inclus, siphon non compris | Bündig Ablaufgarnitur inklusiv, Siphon ausgeschlossen | Desagüe libre alineado incluido, sifón excluido

Installazione | Installation

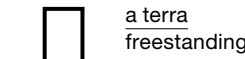

Rubinetteria | Faucet

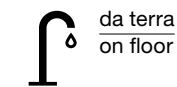
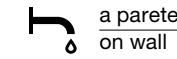

Scarico | Drain

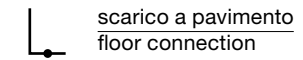
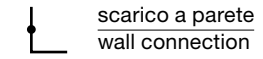

Pesi e volumi | Weight and volume

Kg	Kg	M³
27,1	37,1	0,25

Corian®



Glacier White
C01

Deep Nocturne
C38

Deep Cloud
C42

Carbon Concrete
C41

Graylite
C44

Dune Prima
C43

Neutral Concrete
C40

Ash Aggregate
C45



Carbon Aggregate
C46

Unico Rotondo sospeso

Wall hung Unico Rotondo | Unico Rotondo suspendu | Unico Rotondo an Wand | Unico Rotondo suspendido

Dimensioni | Dimensions

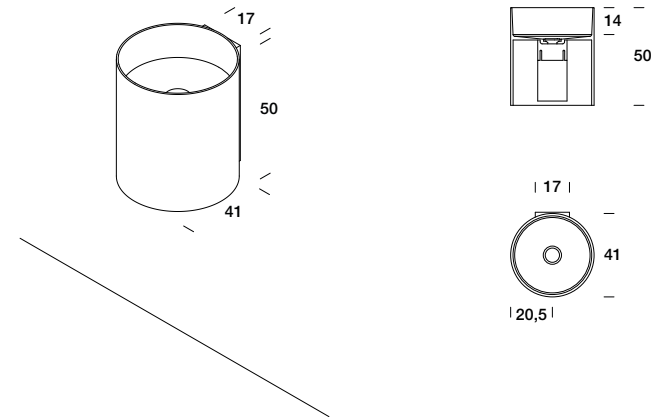

Design by Rexa Design Studio

Piletta a filo scarico libero inclusa, sifone escluso | Free flush flow drain included, siphon not included | Bonde au ras à écoulement libre inclus, siphon non compris | Bündig Ablaufgarnitur inklusiv, Siphon ausgeschlossen | Desagüe libre alineado incluido, sifón excluido

Installazione | Installation

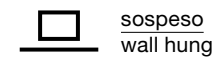

Rubinetteria | Faucet

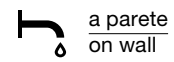

Scarico | Drain

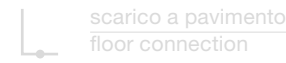
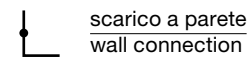

Pesi e volumi | Weight and volume

Kg	Kg	M³
15	25	0,15

Corian®

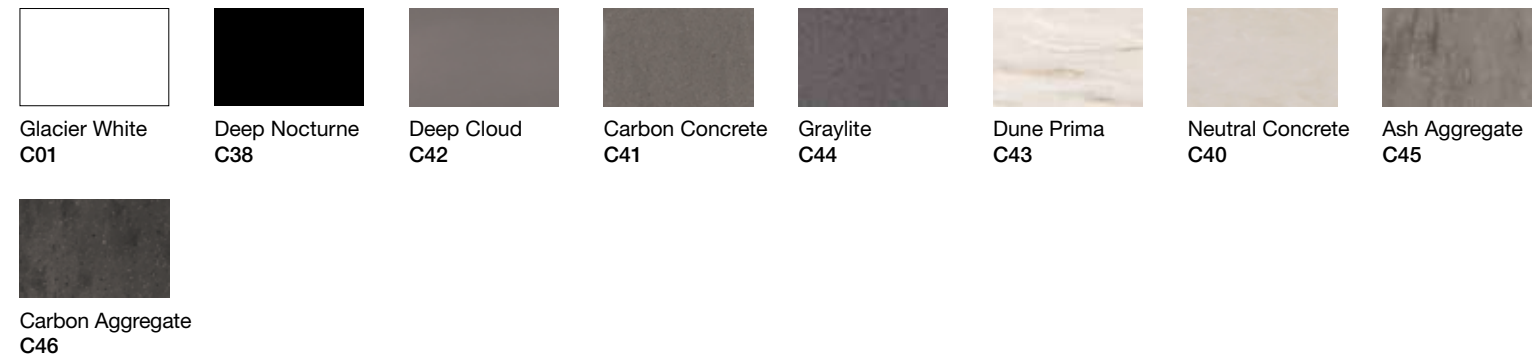

Argo

Dimensioni | Dimensions

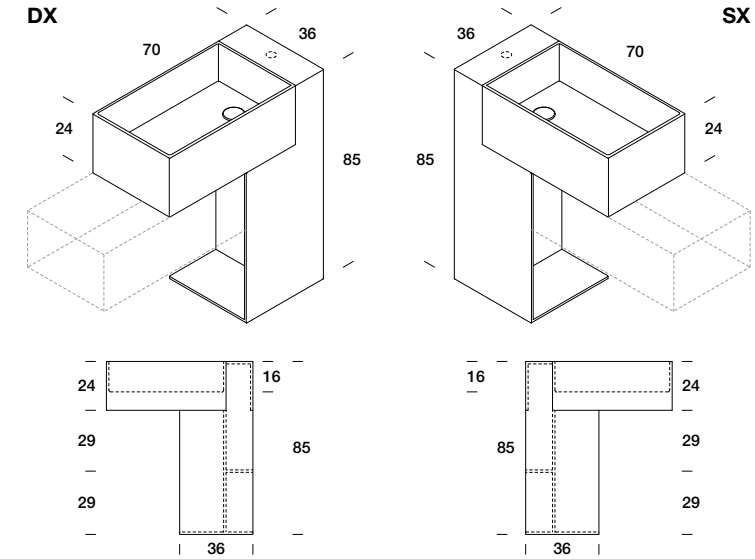

Design by Imago Design

Piletta sporgente scarico libero inclusa, sifone escluso | Free protruding drain included, siphon not included | Bonde proéminent à écoulement libre inclus, siphon non compris | Hervorstehender Ablaufgarnitur inklusiv, Siphon ausgeschlossen | Desagüe libre que sobrasale incluido, sifón excluido

Cassettiera Argo abbinabile P. 101 | Combinable Argo drawer P. 101 | Meuble à tiroirs Argo assorti P. 101 | kombinierbar Argo Schublade S.101 | Cajonera Argo combinable P.101

Installazione | Installation

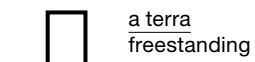

Rubinetteria | Faucet

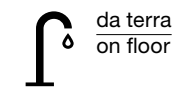
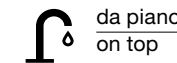
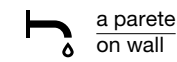

Scarico | Drain

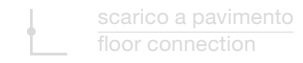
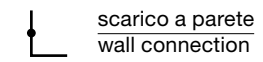

Pesi e volumi | Weight and volume

Kg	Kg	M³
32,9	42,9	0,36

Corian®



Argo sospeso

Wall hung Argo | Argo suspendu | Argo an Wand | Argo suspendido

Dimensioni | Dimensions

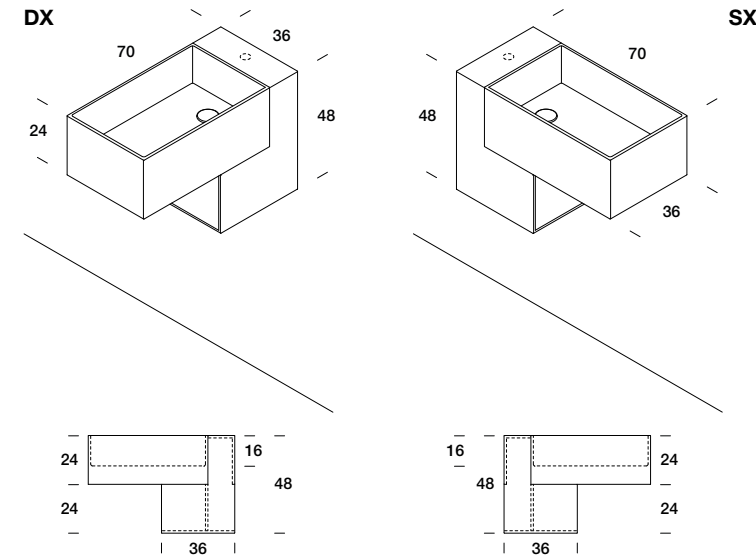

Design by Imago Design

Piletta sporgente scarico libero inclusa, sifone escluso | Free protruding drain included, siphon not included | Bonde proéminent à écoulement libre inclus, siphon non compris | Hervorstehender Ablaufgarnitur inklusiv, Siphon ausgeschlossen | Desagüe libre que sobrasale incluido, sifón excluido

Cassettiera Argo abbinabile P.101 | Combinable Argo drawer P.101 | Meuble à tiroirs Argo assorti P.101 | kombinierbar Argo Schublade S.101 | Cajonera Argo combinable P.101

Installazione | Installation

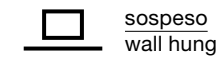

Rubinetteria | Faucet

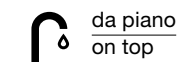
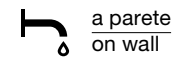

Scarico | Drain

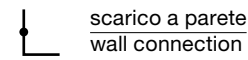

Pesi e volumi | Weight and volume

Kg	Kg	M³
24,7	34,7	0,22

Corian®



Cassettiera Argo sospesa

Wall hung Argo drawer | Argo avec tiroir suspendu | Argo Schublade an Wand | Argo cajón suspendido

Dimensioni | Dimensions

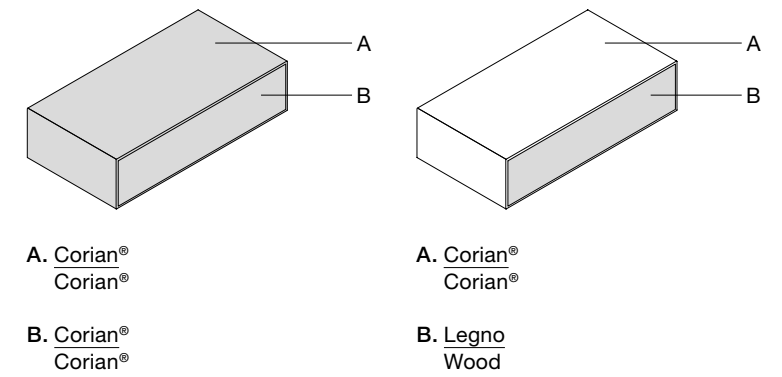
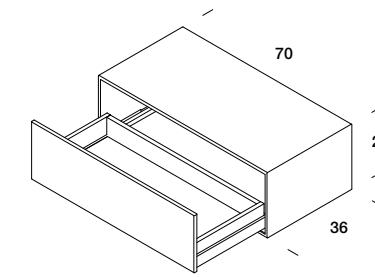

Pesi e volumi | Weight and volume

Kg	Kg	M³
21	25	0,13

Corian® (A / A+B)



Legno | Wood (B)



Unico

Dimensioni | Dimensions

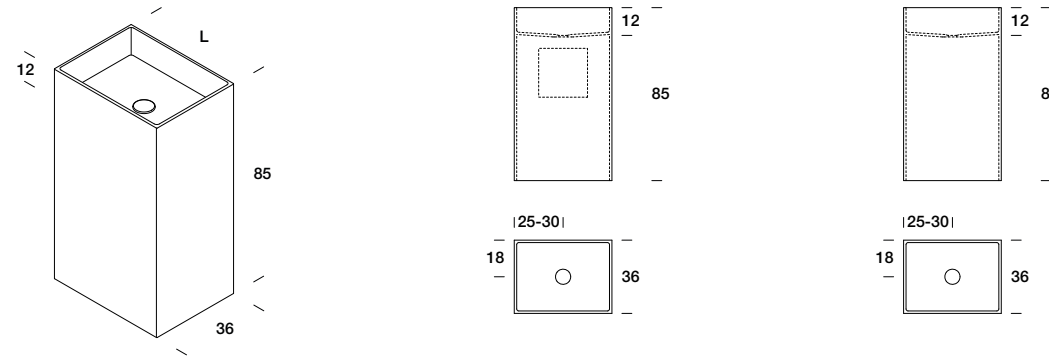

Design by Rexa Design Studio

Piletta sporgente scarico libero inclusa, sifone escluso | Free protruding drain included, siphon not included | Bonde proéminent à écoulement libre inclus, siphon non compris | Hervorstehender Ablaufgarnitur inklusiv, Siphon ausgeschlossen | Desagüe libre que sobrasale incluido, sifón excluido

Spigoli interni raggiati | Radiated inner corners | Arêtes intérieures rayonnées | Strahlenförmig Innenkanten | Arista internas redondeadas



Installazione | Installation

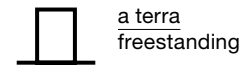

Rubinetteria | Faucet

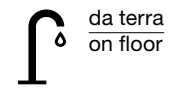
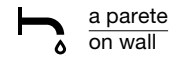

Scarico | Drain

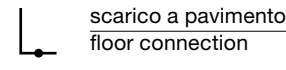
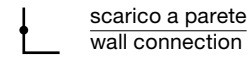

Pesi e volumi | Weight and volume

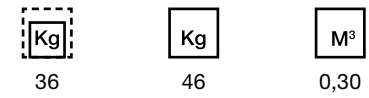

Corian®



Unico

Dimensioni | Dimensions

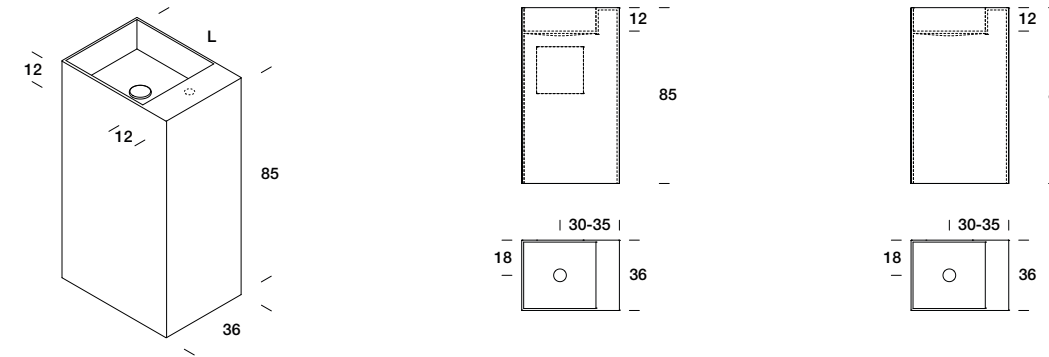

Design by Rexa Design Studio

Piletta sporgente scarico libero inclusa, sifone escluso | Free protruding drain included, siphon not included | Bonde proéminent à écoulement libre inclus, siphon non compris | Hervorstehender Ablaufgarnitur inklusiv, Siphon ausgeschlossen | Desagüe libre que sobrasale incluido, sifón excluido

Spigoli interni raggiati | Radiated inner corners | Arêtes intérieures rayonnées | Strahlenförmig Innenkanten | Arista internas redondeadas



Installazione | Installation

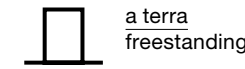

Rubinetteria | Faucet

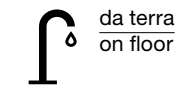

Scarico | Drain

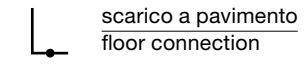
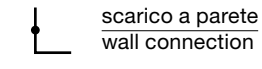

Pesi e volumi | Weight and volume

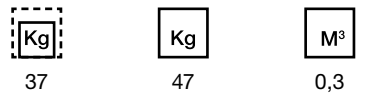

Corian®



Unico

Dimensioni | Dimensions

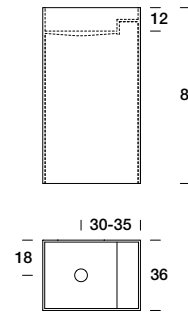
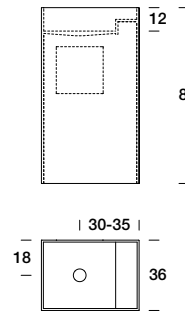
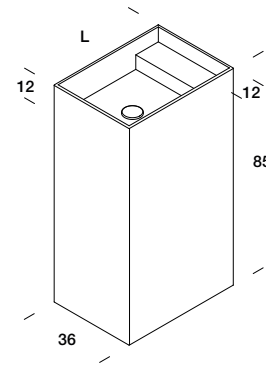

Design by Rexa Design Studio

Piletta sporgente scarico libero inclusa, sifone escluso | Free protruding drain included, siphon not included | Bonde proéminent à écoulement libre inclus, siphon non compris | Hervorstehender Ablaufgarnitur inklusiv, Siphon ausgeschlossen | Desagüe libre que sobrasale incluido, sifón excluido

Spigoli interni vivi | Sharp inner corners | Arêtes intérieures vives | Scharfe Innenkanten | Arista internas afiladas



Installazione | Installation

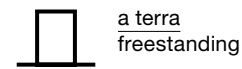

Rubinetteria | Faucet

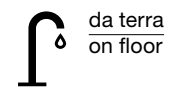
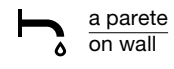

Scarico | Drain

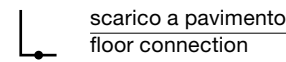
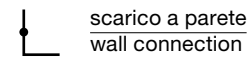

Pesi e volumi | Weight and volume

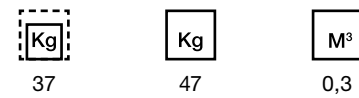

Corian®



Unico

Dimensioni | Dimensions

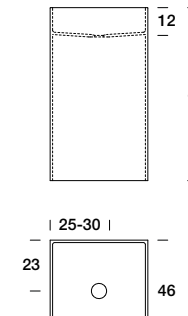
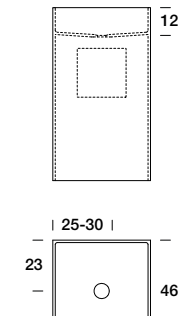
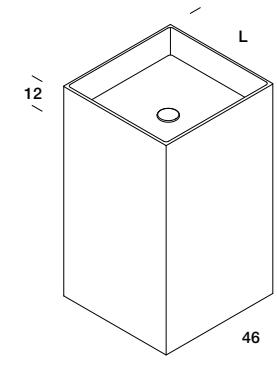

Design by Rexa Design Studio

Piletta sporgente scarico libero inclusa, sifone escluso | Free protruding drain included, siphon not included | Bonde proéminent à écoulement libre inclus, siphon non compris | Hervorstehender Ablaufgarnitur inklusiv, Siphon ausgeschlossen | Desagüe libre que sobrasale incluido, sifón excluido

Spigoli interni raggiati | Radiated inner corners | Arêtes intérieures rayonnées | Strahlenförmig Innenkanten | Arista internas redondeadas



Installazione | Installation

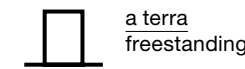

Rubinetteria | Faucet

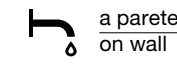

Scarico | Drain

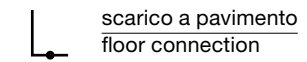
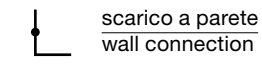

Pesi e volumi | Weight and volume

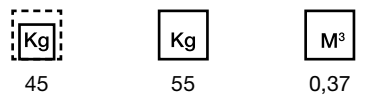

Corian®



Unico

Dimensioni | Dimensions

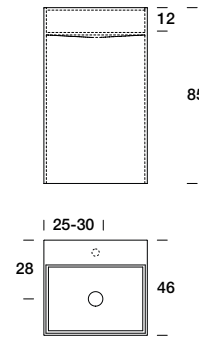
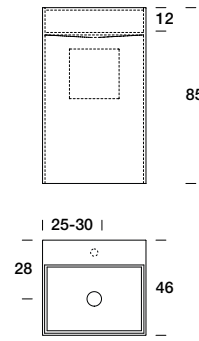
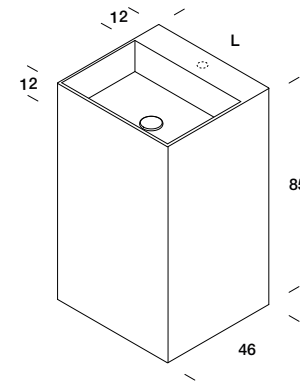

Design by Rexa Design Studio

Piletta sporgente scarico libero inclusa, sifone escluso | Free protruding drain included, siphon not included | Bonde proéminent à écoulement libre inclus, siphon non compris | Hervorstehender Ablaufgarnitur inklusiv, Siphon ausgeschlossen | Desagüe libre que sobrasale incluido, sifón excluido

Spigoli interni raggiati | Radiated inner corners | Arêtes intérieures rayonnées | Strahlenförmig Innenkanten | Arista internas redondeadas



Installazione | Installation

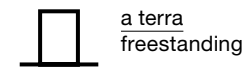

Rubinetteria | Faucet

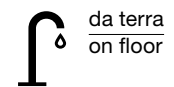
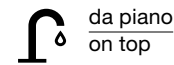
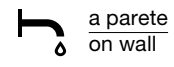

Scarico | Drain

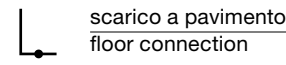
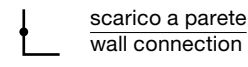

Pesi e volumi | Weight and volume

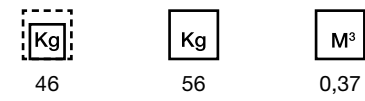

Corian®



Unico sospeso

Wall hung Unico | Unico suspendu | Unico an Wand | Unico suspendido

Dimensioni | Dimensions

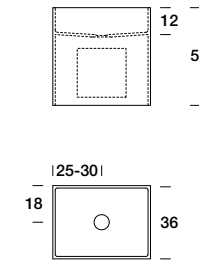
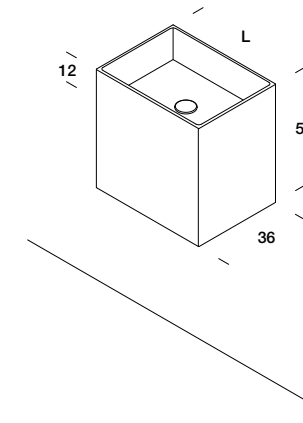

Design by Rexa Design Studio

Piletta sporgente scarico libero inclusa, sifone escluso | Free protruding drain included, siphon not included | Bonde proéminent à écoulement libre inclus, siphon non compris | Hervorstehender Ablaufgarnitur inklusiv, Siphon ausgeschlossen | Desagüe libre que sobrasale incluido, sifón excluido

Spigoli interni raggiati | Radiated inner corners | Arêtes intérieures rayonnées | Strahlenförmig Innenkanten | Arista internas redondeadas



Installazione | Installation

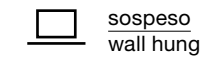

Rubinetteria | Faucet

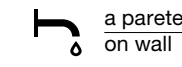

Scarico | Drain

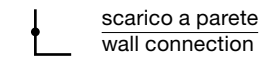

Pesi e volumi | Weight and volume

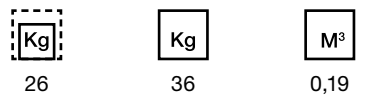

Corian®



Unico sospeso

Wall hung Unico | Unico suspendu | Unico an Wand | Unico suspendido

Dimensioni | Dimensions

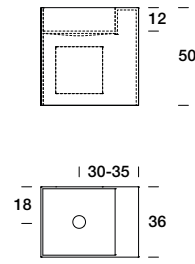
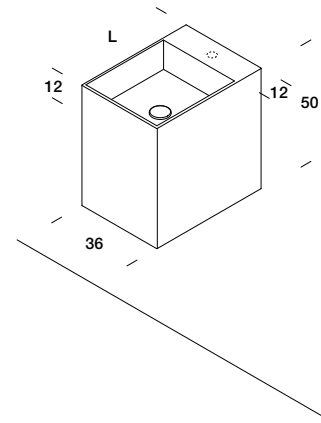

Design by Rexa Design Studio

Piletta sporgente scarico libero inclusa, sifone escluso | Free protruding drain included, siphon not included | Bonde proéminent à écoulement libre inclus, siphon non compris | Hervorstehender Ablaufgarnitur inklusiv, Siphon ausgeschlossen | Desagüe libre que sobrasale incluido, sifón excluido

Spigoli interni raggiati | Radiated inner corners | Arêtes intérieures rayonnées | Strahlenförmig Innenkanten | Arista internas redondeadas



Installazione | Installation

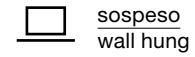

sospeso
wall hung

Rubinetteria | Faucet

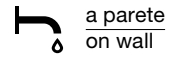

a parete
on wall

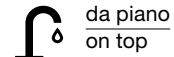

da piano
on top



da terra
on floor

Scarico | Drain

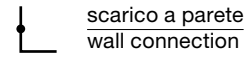

scarico a parete
wall connection



scarico a pavimento
floor connection

Pesi e volumi | Weight and volume



27



37



0,19

Corian®



Unico sospeso

Wall hung Unico | Unico suspendu | Unico an Wand | Unico suspendido

Dimensioni | Dimensions

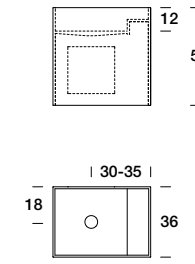
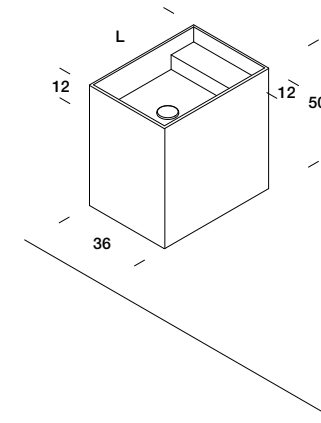

Design by Rexa Design Studio

Piletta sporgente scarico libero inclusa, sifone escluso | Free protruding drain included, siphon not included | Bonde proéminent à écoulement libre inclus, siphon non compris | Hervorstehender Ablaufgarnitur inklusiv, Siphon ausgeschlossen | Desagüe libre que sobrasale incluido, sifón excluido

Spigoli interni vivi | Sharp inner corners | Arêtes intérieures vives | Scharfe Innenkanten | Arista internas afiladas



Installazione | Installation



sospeso
wall hung

Rubinetteria | Faucet

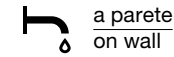

a parete
on wall



da piano
on top



da terra
on floor

Scarico | Drain

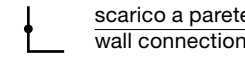

scarico a parete
wall connection



scarico a pavimento
floor connection

Pesi e volumi | Weight and volume



28



38



0,19

Corian®



Unico sospeso

Wall hung Unico | Unico suspendu | Unico an Wand | Unico suspendido

Dimensioni | Dimensions

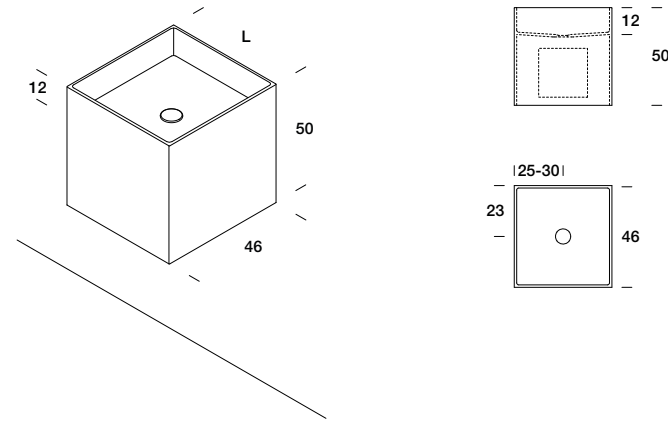

Design by Rexa Design Studio

Piletta sporgente scarico libero inclusa, sifone escluso | Free protruding drain included, siphon not included | Bonde proéminent à écoulement libre inclus, siphon non compris | Hervorstehender Ablaufgarnitur inklusiv, Siphon ausgeschlossen | Desagüe libre que sobrasale incluido, sifón excluido

Spigoli interni raggiati | Radiated inner corners | Arêtes intérieures rayonnées | Strahlenförmig Innenkanten | Arista internas redondeadas



Installazione | Installation

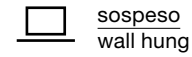

Rubinetteria | Faucet

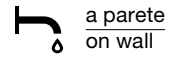

Scarico | Drain

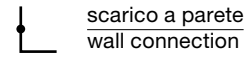

Pesi e volumi | Weight and volume

Kg	Kg	M³
29,3	39,3	0,23

Corian®



Unico sospeso

Wall hung Unico | Unico suspendu | Unico an Wand | Unico suspendido

Dimensioni | Dimensions

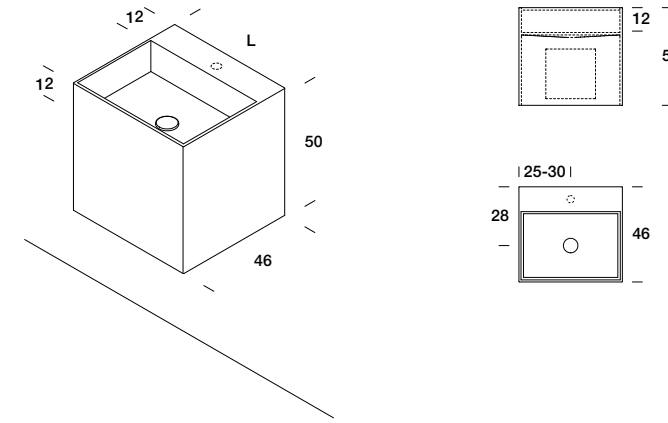

Design by Rexa Design Studio

Piletta sporgente scarico libero inclusa, sifone escluso | Free protruding drain included, siphon not included | Bonde proéminent à écoulement libre inclus, siphon non compris | Hervorstehender Ablaufgarnitur inklusiv, Siphon ausgeschlossen | Desagüe libre que sobrasale incluido, sifón excluido

Spigoli interni raggiati | Radiated inner corners | Arêtes intérieures rayonnées | Strahlenförmig Innenkanten | Arista internas redondeadas



Installazione | Installation

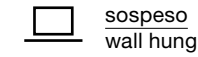

Rubinetteria | Faucet

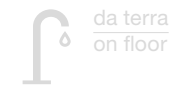
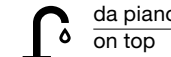
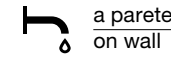

Scarico | Drain

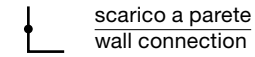

Pesi e volumi | Weight and volume

Kg	Kg	M³
30,3	40,3	0,23

Corian®



Roll

Superficie rigata
Striped surface
Surface rayée
Gestreifte Oberfläche
Superficie rayada

Dimensioni | Dimensions

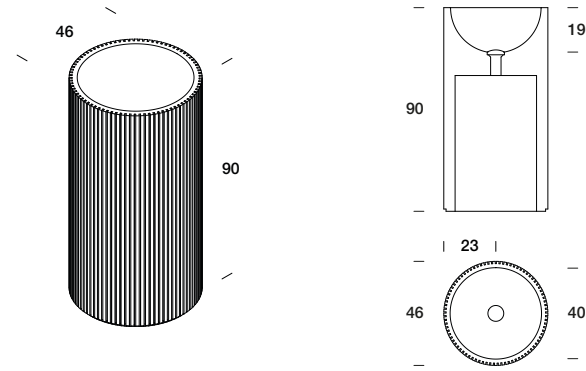

Piletta sporgente scarico libero inclusa, sifone escluso | Free protruding drain included, siphon not included | Bonde proéminent à écoulement libre inclus, siphon non compris | Hervorstehender Ablaufgarnitur inklusiv, Siphon ausgeschlossen | Desagüe libre que sobrasale incluido, sifón excluido

Installazione | Installation

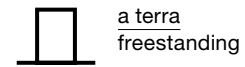

Rubinetteria | Faucet

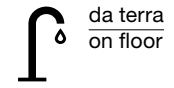
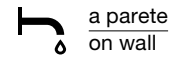

Scarico | Drain

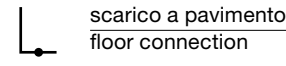

Pesi e volumi | Weight and volume

Kg	Kg	M³
180	210	0,58

Marmo | Marble



Carrara
M01



Nero Marquinia
M09

Roll

Superficie liscia
Smooth surface
Surface lisse
Glatte Oberfläche
Superficie lisa

Dimensioni | Dimensions

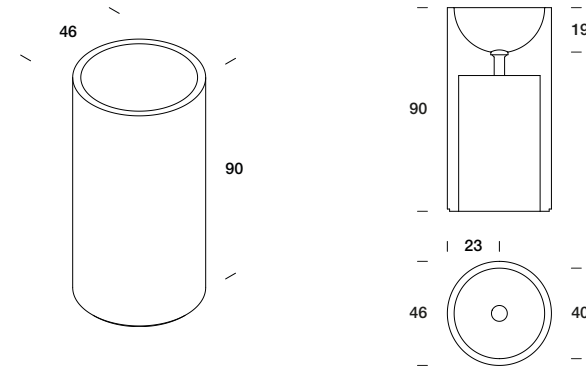

Piletta sporgente scarico libero inclusa, sifone escluso | Free protruding drain included, siphon not included | Bonde proéminent à écoulement libre inclus, siphon non compris | Hervorstehender Ablaufgarnitur inklusiv, Siphon ausgeschlossen | Desagüe libre que sobrasale incluido, sifón excluido

Installazione | Installation

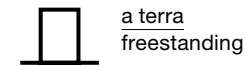

Rubinetteria | Faucet

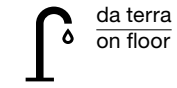
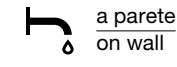

Scarico | Drain

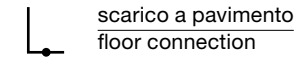

Pesi e volumi | Weight and volume

Kg	Kg	M³
180	210	0,58

Marmo | Marble



Carrara
M01



Nero Marquinia
M09

Funnel

Dimensioni | Dimensions

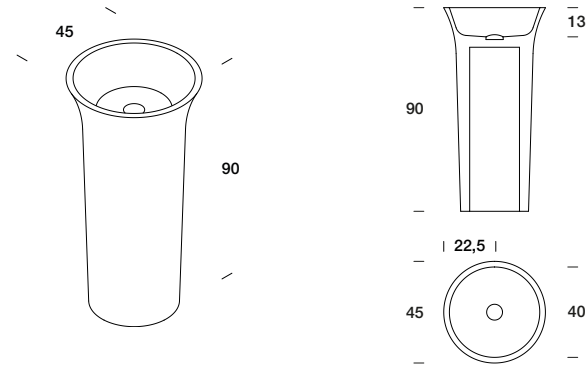

Piletta sporgente scarico libero inclusa, sifone escluso | Free protruding drain included, siphon not included | Bonde proéminent à écoulement libre inclus, siphon non compris | Hervorstehender Ablaufgarnitur inklusiv, Siphon ausgeschlossen | Desagüe libre que sobrasale incluido, sifón excluido

Installazione | Installation

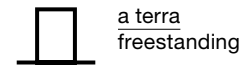

Rubinetteria | Faucet

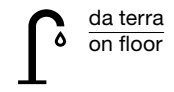
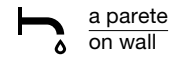

Scarico | Drain

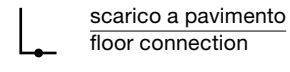
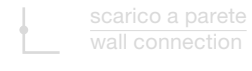

Pesi e volumi | Weight and volume

Kg	Kg	M³
150	180	0,58

Marmo | Marble



Carrara
M01



Nero Marquina
M09

Accessori

Accessories | accessoires | Zubehören | accesorios

Appendino | Hook



L 3
P 5,5
H 6

Legno | Wood



Faggio

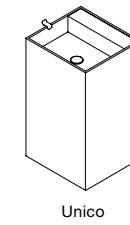
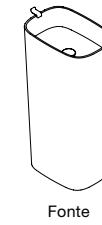
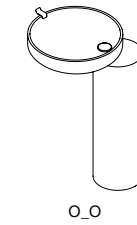

Specchiere

Mirrors | Miroirs | Spiegel | Espejos

Scopri tutte le specchiere sul listino generale |
Discover all mirrors on the general pricelist |
Découvrez tous les miroirs dans la tarif
générale | Entdecken Sie alle Spiegel auf der
allgemeine Preisliste | Descubre todos los
espejos en la lista general

Specchiere | Mirrors

118 Reflex

Reflex

Dimensioni | Dimensions

DX

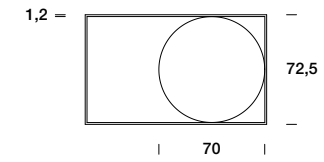
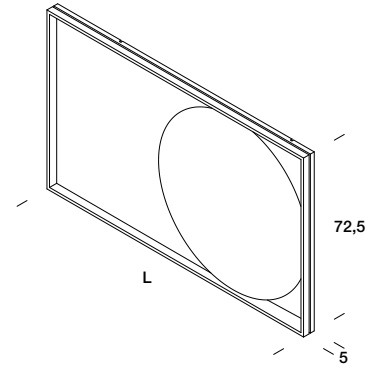

SX

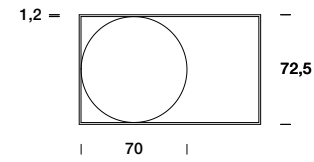
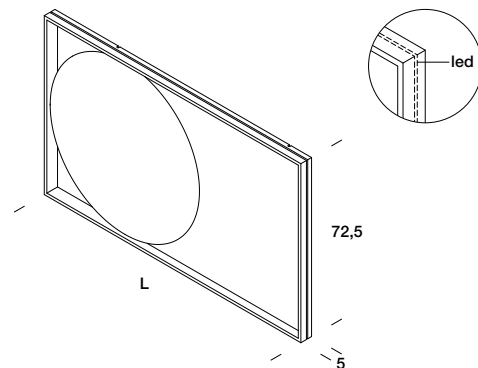

Design by **BMB Progetti**

Cornice in alluminio nero opaco | Black matt aluminium frame | Cadre en aluminium noir mat | Mattschwarzer Aluminiumrahmen | marco de aluminio negro mate

Temperatura | Temperature
3000 K

Illuminazione

Lighting | Éclairage | Beleuchtung | Iluminación

Scopri tutte le lampade sul listino generale | Discover all the lamps on the general pricelist | Découvrez toutes les lampes dans la tarif générale | Entdecken Sie alle Lampen auf der allgemeine Preisliste | Descubre todas las lamparas en la lista general

Illuminazione | Lighting

120 Spin

Specchio | Mirror



Bronzo

Grigio

Specchio standard | Standard mirror

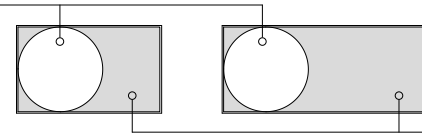

Specchio | Mirror
Grigio | Grey
Bronzo | Bronze

Illuminazione

Lighting | Éclairage | Beleuchtung | Iluminación

Spin



Rotazione max 45-50° | Max rotation 45-50°

Tensione | Voltage
220 V

Potenza | Power
20x41 cm — 20 W
21x21 cm — 8,5 W

Temperatura colore | Color temperature
3000K



CORIAN®						
COD	L	H	GLACIER WHITE	BONE SILVER GREY	DEEP CLOUD / CARBON CONCRETE / NEUTRAL CONCRETE / ELEGANT GREY / DUNE PRIMA / GRAYLITE / ASH AGGREGATE / CARBON AGGREGATE	DEEP NOCTURNE

Spin



Rotazione max 45-50° | Max rotation 45-50°

Tensione | Voltage
220 V

Potenza | Power
8,5 W

Temperatura colore | Color temperature
3000K



CORIAN®					
COD	Ø	GLACIER WHITE	BONE SILVER GREY	DEEP CLOUD / CARBON CONCRETE / NEUTRAL CONCRETE / ELEGANT GREY / DUNE PRIMA / GRAYLITE / ASH AGGREGATE / CARBON AGGREGATE	DEEP NOCTURNE

Materiali

Materials

Corian®



Impiegato per la realizzazione di top, lavabi, piatti doccia, vasche, rivestimenti e accessori | Used for the realisation of tops, washbasins, shower trays, bathtubs, wall panelling and accessories | Employé pour plans, vasques, receveurs de douche, baignoire, revêtement mural et accessoires | Es wurde für die Herstellung von Platten, Waschbecken, Duschtassen und Badewannen entwickelt | Es empleado para la realización de encimeras, lavabos, platos de ducha, bañeras, revestimiento de paredes y accesorios

Corian® è un materiale non poroso, omogeneo e inalterabile alla luce, composto da $\pm 1/3$ di resina acrilica (polimetilmetacrilato o PMMA) e da $\pm 2/3$ di sostanze minerali. Il componente principale è il tri-idrato di alluminio (ATH), minerale derivato dalla bauxite, da cui si ricava l'alluminio. Dal 1967, anno della sua produzione, a oggi il Corian® ha dimostrato di essere un materiale resistente, versatile e igienico. Non essendo poroso, muffe e batteri non trovano appigli e non possono diffondersi nelle giunture o sotto la superficie. Inerte e non tossico, in condizioni normali di temperatura non emette gas. Quando viene bruciato rilascia ossidi di carbonio, il fumo è leggero e non contiene gas alogeni tossici. Per ulteriori informazioni consultare il sito internet: www.dupont.it

Corian® is a solid, non-porous, homogeneous surfacing material, composed of $\pm 1/3$ acrylic resin (also known as Polymethyl Methacrylate or PMMA), and $\pm 2/3$ of natural minerals. These minerals are composed of Aluminium Trihydrate (ATH) derived from bauxite, an ore from which aluminium is extracted. Since its birth in 1967 Corian® has proved to be really resistant, versatile and hygienic. Being a non-porous material, mold and bacteria cannot root nor spread themselves in the joints or under the surface. Corian® is non-toxic and inert. In normal temperature conditions is not emitting gas. If burnt releases mostly carbon monoxide and the light smoke does not have any halogen toxic gas. For further information on its composition, consult the website: www.corian.uk

Corian® est un matériel de revêtement homogène massif et non poreux, composé de $\pm 1/3$ de résine acrylique (également connue sous le nom de Polyméthyle

Méthacrylate ou PMMA), et de $\pm 2/3$ de minéraux naturels. Son composant principal est le Trihydrate de la bauxite (ATH), un minéral dérivé de la bauxite, le minéral dont on extrait l'aluminium. Depuis sa naissance en 1967, Corian® a démontré d'être vraiment résistant, versatile et hygiénique. Etant aussi un matériel homogène et non-poreux, moisissures et bactéries ne se déposent pas ni dans les joint et ni en dessous de la surface. Corian® est inerte et nontoxique. En condition de température normale, il génère aucune émission de gaz. En cas de combustion, il émet surtout des oxydes de carbone et le fumée est léger et contient pas des gaz halogènes toxiques. Pour plus d'information, consultez le site: www.dupontdenemours.fr

Corian® ist ein massives, nicht poröses und homogenes Oberflächenmaterial aus $\pm 1/3$ Acrylharz (auch als Polymethylmetacrylat oder PMMA bekannt) und $\pm 2/3$ natürlichen Mineralien. Der Hauptbestandteil ist das Mineral Aluminiumhydroxid (ATH), das aus Bauxit (Aluminiumerz) gewonnen wird. Seit der Markteinführung im Jahr 1967 hat sich Corian® als langlebiges und nutzerfreundliches Material bewährt. Das porenlose, massive Corian® kann optisch fugenlos verarbeitet werden und verfügt deshalb über eine besonderes hygienische Oberfläche. Diese verhindert das Wachstum von Bakterien oder Schimmelpilzen. Corian® ist ein inaktives, nicht toxisches Material. Bei Normaltemperatur kommt es zu keiner Gasentwicklung. Wird es verbrannt, setzt der Werkstoff hauptsächlich Kohlendioxid frei. Der Rauch ist optisch hell und enthält keine toxischen halogenierten Gase. Informationen zur

Materialzusammensetzung entnehmen Sie bitte dem Corian® auf: www.dupont.de

Corian® es un material no poroso, homogéneo e inalterable a la luz, compuesto de $\pm 1/3$ de resina acrílica (también conocida como Polimetilmetacrilato o PMMA) y $\pm 2/3$ de minerales naturales. Su principal ingrediente es el mineral trihidrato de aluminio (ATH), un derivado de la bauxita que sirve de base para la producción de aluminio. Desde su introducción en 1967, Corian® ha demostrado ser un material resistente, versátil e higiénico. Como no es poroso, el moho y las bacterias no encuentran bodegas y no pueden propagarse en las articulaciones o debajo de la superficie. Corian® es un material inerte y no tóxico. Bajo condiciones normales de temperatura, no emite gases. Cuando se quema, principalmente desprende gas carbónico, el humo que genera es liviano y no contiene gases halogenados tóxicos. Para tener más información sobre la composición del material, consulte Corian® la página: www.dupont.es



non poroso
non porous



igienico
hygienic



termoformabile
thermo-formable



facilmente ripristinabile
easy restorable



assenza di giunzioni
absence of joints



inalterabile alla luce
lightfast

Pulizia Corian®

Uso e manutenzione Corian®

Manutenzione giornaliera A – B – C

Acqua ricca di calcare, sapone, minerali
A – B – F – H

Graffio signicativo, bruciatura di sigaretta,
inchiostro, segni di penna A – B – C – E – H

Mercurocromo, sangue, profumo A – B – C –
D – E – H

Smalto per unghie A – B – C – G – H

Ferro o ruggine A – B – C – G – H

Iodio A – B – C – E – H

Corian® colorato A – B – G

Agire sempre con movimenti circolari.
Se non viene rimossa completamente
risciacquando con acqua, la candeggina
può scolorire il Corian®.

Metodi di pulizia

A. Rimuovere il residuo con un panno.

B. Sciacquare la superficie con acqua calda e
asciugare con un panno morbido.

C. Usare un panno umido e una crema
abrasiva leggera (es. Cif).

D. Usare una spugna, strofinare sulla
macchia con un prodotto detergente a base
di ammoniac.

E. Usare una spugna, strofinare sulla
macchia con candeggina diluita con

acqua, sciacquare più volte con acqua
calda e asciugare con un panno morbido.

F. Usare una spugna e strofinare sulla
macchia con un prodotto di pulizia
anticalcare (tipo Viakal®) o aceto.
Sciacquare più volte con acqua calda ed
asciugare con un panno morbido.

G. Usare una spugna e strofinare sulla
macchia con un prodotto privo di acetone.
Sciacquare più volte con acqua calda ed
asciugare con un panno morbido.

H. Se le macchie persistono, contattare
Rexa Design (tel: 0434 593182).

Molti danni dovuti a urti, calore o prodotti
chimici possono essere riparati solitamente
sul luogo ridando integralmente alla
superficie il suo aspetto originale, regolare,
igienico.

Cleaning methods for Corian®

Corian® use and maintainance

For everyday cleaning A – B – C

Water rich of limestone, soaps, minerals
A – B – F – H

Light scratch, cigarette burns, ink, marker
pen A – B – C – E – H

Mercurochrome, blood, perfume
A – B – C – D – E – H

Nail varnish spills A – B – C – G – H

Iron or rust A – B – C – G – H

Iodine A – B – C – E – H

Colored Corian® A – B – G

Always clean using circular motion.
Bleach can discolour Corian® if not
removed completely by rinsing with water
afterwards.

Cleaning methods

A. Remove excess with a soft cloth.

B. Rinse surface with warm water and dry
with a soft cloth.

C. Use a damp microfiber cloth and a light
abrasive cream.

D. Use a microfiber cloth and wipe the
stain with an ammonia detergent

E. Use a microfiber cloth and rub over the
stain with some diluted bleach. Rinse
several times with warm water and dry with
a soft cloth.

F. Use a microfiber cloth and rub over the

stain with a standard household lime-scale
remover (Viakal®, Lime-lite) or vinegar .
Rinse several times with warm water and dry
with a soft cloth.

G. Use a microfiber cloth and rub over the
stain with a non-acetone based Nail varnish
remover. Rinse several times with warm
water and dry with a soft cloth.

H. If the stains persist, contact Rexa Design
(tel: +39 0434 593182).

Most damages, including sever impact, heat
or chemical damage, can usually be
repaired on site to restore the original,
smooth, hygienic solid surface integrity.



Corian® Methodes de nettoyage

Corian® utilisation et maintenance

Nettoyage quotidien A – B – C

Dépôt calcaire, savons, minéraux
A – B – F – H

Égratignure importante, brûlure de
cigarette, encre, marques de stylo
A – B – C – E – H

Mercurochrome, sang, parfum
A – B – C – D – E – H

Vernis à angle A – B – C – G – H

Fer ou rouille A – B – C – G – H

Iode A – B – C – E – H

Corian® coloré A – B – G

Nettoyez toujours en effectuant un
mouvement circulaire. L'eau de javel risque
de décolorer le Corian® si elle n'est pas
ensuite rincée complètement à l'eau.

Methodes de nettoyage

A. Épongez avec un chiffon doux.

B. Rincez à l'eau chaude et séchez avec un
chiffon doux.

C. Utilisez un chiffon humide et un détergent
doux en crème (type Cif).

D. Utilisez une éponge et frottez la tâche
avec un détergent ou un nettoyant pour
surface dure à l'ammoniaque dilué (type Ajax
ou Monsieur Propre).

E. Utilisez une éponge à récurer et frottez la

tâche avec un peu d'eau de javel dilué.
Rincez plusieurs fois à l'eau chaude, puis
séchez avec un chiffon doux.

F. Utilisez une éponge à récurer et frotter la
tâche avec un produit anti-calcaire (type
Viakal®) ou de vinaigre. Rincez plusieurs
fois à l'eau chaude, puis séchez avec un
chiffon doux.

G. Utilisez une éponge à récurer et frottez la
tâche avec un dissolvant à ongles sans
acétone. Rincez plusieurs fois à l'eau
chaude, puis séchez avec un chiffon doux.

H. Si la tache persiste, contactez Rexa
Design (tel: +39 0434 593182).

La plupart des dégâts, y compris les
dommages importants dus à un choc, à la
chaleur ou à des produits chimiques, sont
habituellement réparables sur place pour
redonner aux

Corian® metodos de limpieza

Corian® uso y mantenimiento

Para la limpieza cotidiana A – B – C

Cal de agua dura, jabon, minerales
A – B – F – H

Rasguños significativos, quemaduras de
cigarrillos, tinta, marcas de lápiz
A – B – C – E – H

Sangre, vino, perfume A – B – C – D – E – H

Manchas de esmalte de uñas
A – B – C – G – H

Hierro u oxidacion A – B – C – G – H

Yodo A – B – C – E – H

Corian® de colores A – B – G

Siempre limpie con movimientos circulares.
La Lejia puede dejar manchas blancas en
la superficie de Corian® si no se aclare con
agua abundante.

Metodos de limpieza

A. Elimine manchas con un trapo suave.

B. Aclare la superficie con agua caliente y
segue con un trapo suave.

C. aplique una crema ligeramente abrasiva
(como Cif) con un paño mojado.

D. Con un estropajo que esté gastado frote
la mancha con un producto para limpiar
superficies sólidas a base de amoniaco.

E. Con un estropajo que esté gastado frote
la mancha con un poco de lejia diluida.
Aclare varias veces con agua caliente y

Corian® Reinigungsmethode

Corian® gebrauch und wartung

Tägliche Reinigung A – B – C

Kalk-, Seifen- Mineralablagerungen
A – B – F – I

Lilienpollen, Safran, leichte Kratzer,
Zigarettenbrandfleck Tinte, Filzstift
A – B – C – E – I

Mercurochrom, Blut, Rotwein, Parfum
A – B – C – D – E – I

Nagellack A – B – C – G – I

Eisen oder Rost A – B – C – H – I

Jod A – B – C – E – I

*Reinigen Sie die Oberfläche immer mit
kreisenden Bewegungen
**Bleiche sofort mit Waser vollständig
abspülen, andernfalls kann sich die Corian®
Oberfläche verfärben.

Reinigungsmethode

A. Rückstände mit einem weichen Tuch
entfernen.

B. Oberfläche mit warmen Wasser abspülen und
mit einem weichen Tuch trockenwischen.

C. Ein feuchtes Tuch und eine milde
Scheuermilch verwenden (z.B. Viss, Frosch
Scheuermilch).

D. Mit einem abrasiven Scheuerschwamm
(z.B. Scotch Brite®) und einem Reinigungs-
mittel oder Reiniger für Massivoberflächen auf
Ammoniakbasis (z.B. Ajax, Meister Proper,

General) über den Fleck reiben.

E. Mit einem abrasiver Scheuerschwamm
(z.B. Scotch Brite®) und Haushaltsbleiche.
Oberfläche mehrmals mit warmem Wasser
abspülen und mit einem weichen Tuch
trockenwischen.

F. Mit einem abrasiver Scheuerschwamm (z.B.
Scotch Brite®) und einem standard-mäßigen
Haushaltsmittel zur Entfernung von
Kalkablagerungen (Sido) oder Essig über den
Fleck reiben. Oberfläche mehrmals mit warmem
Wasser abspülen und mit einem weichen Tuch
trockenwischen.

G. Mit einem abrasiver Scheuerschwamm
(z.B. Scotch Brite®) und einem acetonefreien
Nagellackentferner über den Fleck reiben.
Oberfläche mehrmals mit warmem Wasser
abspülen und mit einem weichen Tuch
trockenwischen.

H. Mit einem abrasiver Scheuerschwamm (z.B.
Scotch Brite®) und einem Metallreiniger
oder Rostentferner über den Fleck reiben.
Oberfläche mehrmals mit warmem Wasser
abspülen und mit einem weichen Tuch
trockenwischen.

I. Wenn Flecken nicht entfernt werden können,
setzen Sie sich mit Rexa Design (tel: +39 0434
593182) in Verbindung.

Die meisten Schäden, ei nschließlich Schäden,
die durch starke Schläge, Hitze oder Chemikalien
verursacht wurden, können in der Regel vor Ort
beseitigt werden. Die Oberfläche erhält dadurch
ihre ursprüngliche, glatte, hygienische und
massive Oberflächenbeschaffenheit zurück.



I Marmi e i Graniti selezionati offrono la possibilità di inserire in casa materiali naturali con toni abbinabili alle collezioni bagno. Il Marmo bianco di Carrara lascia trasparire un leggero grigio chiaro che si scurisce nelle venature. I marmi: Carrara, Grigio Veneto, Marquinia, Grigio Carnico ed Emperador sono caratterizzati da venature. Sulla superficie dei marmi sono presenti delle porosità. Il Nero Assoluto è un Granito naturale nero, resistente, con un bassissimo assorbimento e una texture uniforme contenente piccoli elementi in avorio.

Marbles and Granites selected offer the opportunity to incorporate natural materials at home with tones matching the bathroom collections. The white Carrara marble reveals a light gray which darkens in the grain. The marbles: Carrara, Grigio Veneto, Marquinia, Grigio Carnico and Emperador are characterized by their veins. Porosity can be seen on the surface of marbles. The Nero Assoluto is a natural black granite, resistant, with very low absorption and a uniform texture containing small items made of ivory.

Marbres et granits sélectionnés offrent la possibilité d'insérer chez soi des matériaux naturels avec des tons correspondants aux collections de salle de bains. Le marbre blanc de Carrare révèle un gris clair qui obscurcit dans le veinage: Le marbre: Carrara, Grigio Veneto, Marquinia, Grigio Carnico et Emperador se caractérisent par leurs veines. Sur la surface des marbres il est possible de percevoir la porosité. Le granit Nero Assoluto noir est un produit naturel, durable, avec une très faible absorption et une texture uniforme contenant de petites parties en ivoire.

Ausgewählte Marmors und

Lavabi a terra e sospesi

Materiali

Impiegato per la realizzazione dei top integrati e lavabi | Used for the realization of integrated top and washbasins | Utilisé pour la réalisation de plans intégrés et vasques | Wird für die Produktion von integrierten Waschbecken und Waschbecken verwendet | Se utiliza para la realización de la lavabo integrados y lavabos.

Pulizia
Pulire la superficie con acqua e detersivi neutri. I piani vengono trattati con un prodotto specifico (olio/idrorepellente) per migliorare le caratteristiche di resistenza all'assorbimento. È consigliabile trattare il piano con prodotti protettivi almeno una volta all'anno.



poroso
porous



resistente
resistant

Cleaning
Clean the surface with water and mild detergents. The plans are treated with a specific product (oil/water-repellent) to improve the characteristics of resistance to the absorption. It is recommended to treat the top with protective products at least once a year.

Nettoyage
Nettoyer la surface avec de l'eau et des détergents doux. Les plans sont traités avec un produit spécifique (huile/produit hydrofuge) pour améliorer les caractéristiques de résistance à l'absorption. Il est recommandé de traiter le plan avec des produits de protection au moins une fois par année.

Reinigung
Reinigen Sie die Oberfläche mit Wasser und einem milden Reinigungsmittel. Die Platten werden mit einem bestimmten Produkt (Öl/Dichtmittel) behandelt, um die Eigenschaften der Beständigkeit gegen die Absorption zu verbessern. Es wird empfohlen, die Platte mit Schutzprodukten mindestens einmal im Jahr zu behandeln.

Limpieza
Limpiar la superficie con agua y detergentes suaves. Las encimeras son tratadas con un producto específico (aceite/sellante) para mejorar las características de resistencia a la absorción. Se recomienda tratar la encimera con productos de protección al menos una vez al año.

126



Impiegato per la realizzazione del lavabo Discovolante | Used for the realization of Discovolante basin | Utilisé pour la réalisation du lavabo Discovolante | Wird für die Herstellung des Discovolante Waschbecken verwendet | Es empleado para la realización de lavabo Discovolante en vidrio.

Vetro che si ottiene tramite la solidificazione di un liquido viscoso, ottenuto per fusione di minerali cristallini. Il vetro è temperato e trattato con anticalcare. Colorato in pasta, grazie all'aggiunta di elementi naturali che ne caratterizzano il colore.

Glass is obtained through the solidification of a viscous liquid, obtained by melting of crystalline minerals. The glass is tempered and treated with a descaler. Paste colored thanks to the addition of natural elements which characterizes the color.

Verre obtenu par la solidification d'un liquide visqueux et par fusion de minéraux cristallins. Le verre est trempé et traité avec anticalcaire. Coloré en pâte, grâce à l'ajout d'éléments naturels qui caractérisent la couleur.

Glas, das durch Verfestigung einer zähen Flüssigkeit gewonnen wird, die durch Schmelzen von kristallinen Mineralien gewonnen wird. Glas ist gehärtet und mit Kalklösend behandelt. Farblich im Teig, durch den Zusatz natürlicher Elemente, die seine Farbe charakterisieren.

Vidrio que se obtiene mediante la solidificación de un líquido viscoso, obtenido por fusión de minerales cristalinos. El vidrio es templado y tratado con anticalcare. Coloreado en pasta, gracias a la adición de elementos naturales que caracterizan el color.

Pulizia
Utilizzare i normali prodotti per la pulizia del vetro avendo cura di risciacquare e asciugare bene.

Cleaning
Use normal glass cleaning products taking care to rinse and dry well.

Nettoyage
Utilisez des produits de nettoyage pour verre normaux en prenant soin de bien rincer et bien sécher.

Reinigung
Zur Reinigung nur neutrale Reinigungsmittel und keinen aggressiven Entkalker verwenden.

Limpieza
Use productos de limpieza de vidrio normales teniendo cuidado de enjuagar y secar bien.



inalterabile alla luce
lightfast



riciclabile
recyclable

127

Materials

Freestanding and wall hung washbasins